

# Radio-Electronics

MAY

TELEVISION • SERVICING • HIGH FIDELITY

**Servicing Stacked-B TV's**

**Modulation Monitor  
For Citizens Band**

**Build:**

**Quality Stereo Amplifier**

**"Electronic Dry Cell"**

HUGO GERNSBACK, Editor



50c

**The Optical Maser—  
Communications at  
450,000,000 Mc!**

JAMES D MC NEAL 2-65  
40 MIDDLETOWN AVE  
NORTH HAVEN CONN

**"Score" more profits**



“NEW FROM SYLVANIA & RTTA!”

“TECHNIQUES OF RADIO SERVICING” COURSE

“STUDY AT HOME!” 12 LESSON COURSE FROM RTTA

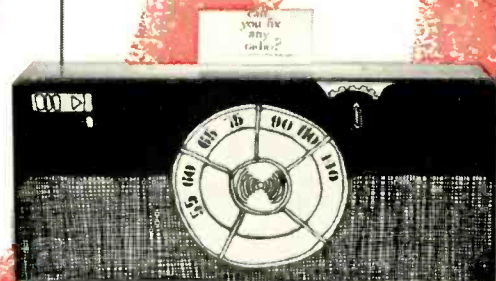

Enroll in the Sylvania “advanced radio repair course”

Radio is “booming.” Sales hit a ten-year high in 1960 . . . over 10 million! You can “zero in” on extra servicing profits by signing up for the Sylvania sponsored RTTA “Advanced Techniques of Radio Servicing Course.”

This new Sylvania 12-lesson *home study* course covers all the latest servicing techniques on the tremendous variety of radios your present customers own and expect you to service. Shows you how to complete repairs quickly, efficiently, profitably. Gives you the latest dope on everything from transistor circuits to citizen band radio. Look at the subjects covered:

- working with transistors
- transistor circuits
- repairing auto radios
- servicing AM receivers
- servicing AM & FM tuners
- servicing foreign radios
- servicing mobile receivers
- testing transistors
- servicing transistor radios
- installing auto radios
- servicing FM receivers
- servicing communications receivers
- marine radio repair
- servicing citizen band radio

It's easy to enroll. Your Sylvania tube distributor has all the details. Call him today. And when you order tubes be sure to specify Sylvania Silver Screen 85 picture tubes and Sylvania quality receiving tubes.

Electronic Tubes Division, Sylvania Electric Products Inc., 1740 Broadway, New York 19, New York.

**SYLVANIA**

SUBSIDIARY OF

**GENERAL TELEPHONE & ELECTRONICS**



# PICK THE CAREER YOU WANT IN THE WONDERFUL FIELD OF ELECTRONICS TRAIN AT HOME WITH THE LEADER

Practice with  
Special Training  
Equipment  
Furnished

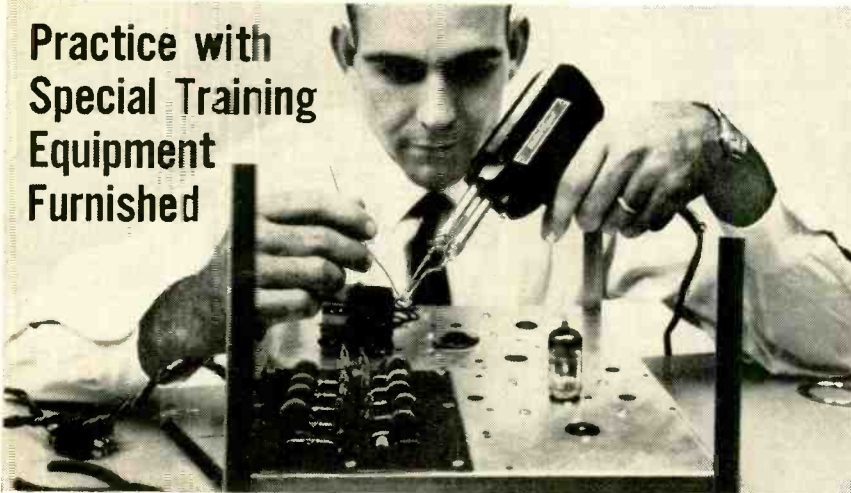

## INDUSTRIAL ELECTRONICS



*Electronics—Principles, Practices, Maintenance* prepares you for a career as an Electronic Technician in industry, business or with the government. Computers, telemetry, automation, missiles, rockets are changing our world, yet all employ the same *basic Electronic principles* . . . and that is what this NRI course stresses with illustrated lessons, special training equipment furnished.

## TELEVISION-RADIO SERVICING



You not only learn to fix radios, TV sets, etc., but we also show you how to earn spare-time money starting soon after enrolling. Fast growth in number of sets means money-making opportunities for you in your own spare-time or full-time business, or working for someone else. NRI makes learning easy, interesting, practical. You get special training equipment at no extra cost.

## TV-RADIO COMMUNICATIONS



As a technician you help broadcast the Radio and TV programs you watch at home. NRI prepares you for an FCC license—for job opportunities operating, servicing, and maintaining AM, FM, TV broadcasting station transmitting equipment; two-way radio for police, marine, aviation, industry. As with other courses, NRI furnishes special training equipment at no extra cost. Mail coupon now.

There is an immediate and growing need for trained technicians in Industrial-Military Electronics, Radio-Television Servicing and Radio-TV Communications. Better than average jobs with high pay, interesting work, bright futures await you in the fast growing industry of the 1960's. Join the many NRI graduates now benefiting from career opportunities in this Electronic Age.

### Job Counselors Recommend

Job counselors advise investigating Electronics if you are not content with your present job or pay, or are worried about your future. Thousands have moved up to better careers in business and industry, in broadcasting stations or in the servicing business through NRI training.

### High Pay, Bright Future

You must be *trained* to qualify for higher earnings and advancement. Whichever branch of Electronics you select, you'll find NRI training is the time proved way to get into this big and fast growing industry. NRI "learn-by-practice" methods, using special equipment, make training easier, interesting, practical.

### Largest School of its Kind

For over 45 years NRI has featured Electronics training, progressing from Radio to TV to Industrial Electronics. NRI supplies training at reasonable cost because it is the oldest, largest home-study school of its kind. Take the first step to a successful new career now. Mail coupon for FREE CATALOG. National Radio Institute, Washington 16, D. C.

## MAIL TODAY



**NRI** National Radio Institute  
Washington 16, D. C. IEF

Please send your catalog. I am interested in training checked below.  
(No representative will call. Please Print)

- INDUSTRIAL ELECTRONICS  
 TV-RADIO SERVICING  
 TV-RADIO COMMUNICATIONS  
 FCC LICENSE

Name \_\_\_\_\_ Age \_\_\_\_\_

Address \_\_\_\_\_

City \_\_\_\_\_ Zone \_\_\_\_\_

State \_\_\_\_\_

Accredited Member National Home Study Council

RADIO-ELECTRONICS published monthly at Mt. Morris, Ill., by Gernsback Publications Inc. Second-class postage paid at Mt. Morris, Ill. Copyright © 1961, by Gernsback Publications Inc. All rights reserved under Universal, International and Pan-American Copyright Conventions. SUBSCRIPTION RATES: US and possessions, Canada: \$5 for 1, \$9 for 2, \$12 for 3 years. Pan-American countries: \$6 for 1, \$11 for 2, \$15 for 3 years. Other countries: \$6.50 for 1, \$12 for 2, \$16.50 for 3 years.

# Radio-Electronics

Formerly RADIO CRAFT — Incorporating SHORT WAVE CRAFT — TELEVISION NEWS — RADIO & TELEVISION\*

MAY 1961  
VOL. XXXII NO. 5

## editorial

Hugo Gernsback 31 Inventions Wanted

## audio-high fidelity

- Edward A. Laurent 35 Quality Stereo Amplifier  
*Build a dual 20-watt*
- Jack Darr 47 Servicing Tape Recorders, Part I  
*Covers mikes, amplifiers, bias-erase oscillators*
- 78 Hushpuppy
- Stephen A. Kallis, Jr. 80 Install a Wide-Range Speaker System in Your Car  
*Build a woofer-tweeter rear-deck enclosure*

## television

- E. D. Lucas, Jr. 37 Transistor Tuners for TV, Part II  
*Describes the Standard Coil Motorola unit*
- H. R. Holtz 39 A Loud Picture
- Conducted by Jack Darr 60 TV Service Clinic  
*Cascade circuits, plus answers to your questions*
- Jack Darr 69 Servicing Stacked-B Circuits  
*This circuit has its own service problems*
- Wayne Lemons 82 Lucky Hunts Low High Voltage  
*And learns more about horizontal oscillators*

## test instruments

- 42 Repair Electronic Watches  
*Describing a new instrument for the purpose*
- Jack Lipiner 66 Billion-Ohm Continuity Checker  
*It checks leakage and injects signals, too*
- I. Queen 74 Crystal Beatnik Oscillator  
*Get many frequencies from two crystals*
- James A. Fred 86 Simple Voltage Control Box  
*You can build it yourself*

## industrial electronics

- Gene Jackson 44 Four-Layer Diodes and Controlled Rectifiers—What Are They?  
*Do you understand them? Then read this!*

## radio

- Nicholas A. Tax 32 Flip-top Radio  
*Cigarette-pack size, it has four-transistors*
- Lyman E. Greenlee 53 Modulation Monitor Checks CB Transmitters  
*Improve your Citizens band transmissions*
- E. G. Eslick 76 Basic Servicing Tricks  
*Some kinks for the new technician*

## electronics

- Donald L. Stoner 40 Electronic Dry Cell  
*Build an absolutely regulated power supply*
- Larry Steckler 50 How Fuses Work  
*Not-so-common information on a common device*
- 56 What's Your EQ?
- R. J. Collins and D. F. Nelson 57 Communication at 450,000,000 Mc  
*How the revolutionary new optical maser works*
- Rufus P. Turner 88 Care and Handling of Tunnel Diodes  
*A little knowledge can save you money!*
- John A. Comstock 68 Electronics Numbers Puzzle

## the departments

108 Business and People  
16 Correspondence  
112 New Books  
22 New Literature

104 New Patents  
89 New Products  
101 New Tubes & Semiconductors

6 News Briefs  
99 Noteworthy Circuits  
94 Technicians' News

97 Technotes  
106 Try This One  
96 50 Years Ago

## Over 50 Years of Electronic Publishing

EDITOR AND PUBLISHER  
Hugo Gernsback

EDITORIAL DIRECTOR  
M. Harvey Gernsback

MANAGING EDITOR  
Fred Shunaman

TECHNICAL EDITOR  
Robert F. Scott, W2PWG

ASSOCIATE EDITOR  
Larry Steckler

EDITORIAL ASSOCIATE  
I. Queen

SERVICE DIRECTOR  
Jack Darr

ART DIRECTOR  
Harry Schlack

TECH. ILLUSTRATION DIRECTOR  
Wm. Lyon McLaughlin

ART ASSOCIATE  
Fred Neinast

PRODUCTION MANAGER  
Elizabeth Stalcup

DIRECTOR, ADVERTISING SALES  
Lee Robinson

EASTERN SALES MANAGER  
John J. Lamson

CIRCULATION MANAGER  
G. Aliquo

DIRECTOR, NEWSSTAND SALES  
Adam J. Smith

PROMOTION MANAGER  
Robert Fallath

Average Paid Circulation  
Over 160,000



## on the cover

R. J. Collins of Bell Laboratories operates the new optical maser that may revolutionize communications.

Bell Labs photo by Dan Rubin

See page 57

Radio-Electronics is indexed in  
Applied Science & Technology Index  
(Formerly Industrial Arts Index)

Gernsback Publications, Inc.

EXECUTIVE, EDITORIAL, ADVERTISING  
OFFICES

154 W. 14 St., New York 11, N.Y.  
Telephone AL 5-7755

CHAIRMAN OF THE BOARD  
Hugo Gernsback

PRESIDENT  
M. Harvey Gernsback

SECRETARY  
G. Aliquo

# BREAK THROUGH TO HIGHER PAY

in **ELECTRONICS**

# TV-RADIO

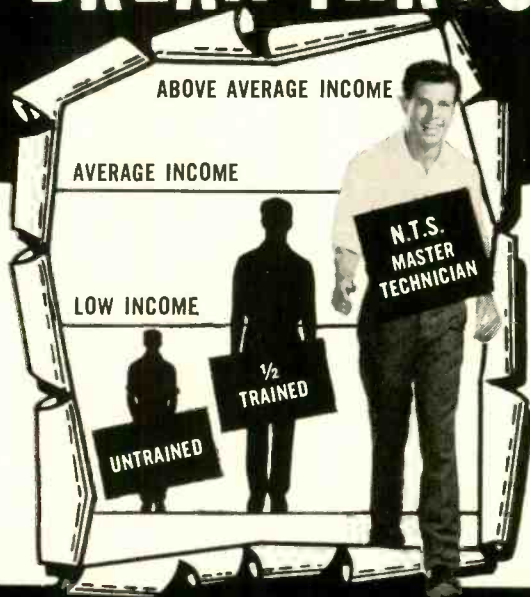

**START NOW!** Break through the Earning Barrier that stops half-trained men. N.T.S. "All-Phase" training prepares you — at home in spare time — for a high-paying CAREER in Electronics — TV — Radio as a MASTER TECHNICIAN. One Master Course at One Low Tuition trains you for unlimited opportunities in All Phases: Servicing, Communications, Preparation F.C.C. License, Broadcasting, Manufacturing, Automation, Radar and Micro-Waves, Missile and Rocket Projects.

A more rewarding job... a secure future... a richer, fuller life can be yours! As an **N. T. S. MASTER TECHNICIAN** you can go straight to the top in industry... or in your own profitable business.

You work on actual job projects



## SUCCEED IN MANY HIGH-PAYING JOBS LIKE THESE...

- TV-Radio Sales, Service and Repair
- Profitable Business of Your Own
- Communications Technician — F.C.C. License
- Hi-Fi, Stereo & Sound Recording Specialist
- TV-Radio Broadcasting Operator
- Technician in Computers & Missiles
- Electronics Field Engineer
- Specialist in Microwaves & Servomechanisms
- Expert Trouble Shooter
- All-Phase Master Technician

## 19 BIG KITS YOURS TO KEEP

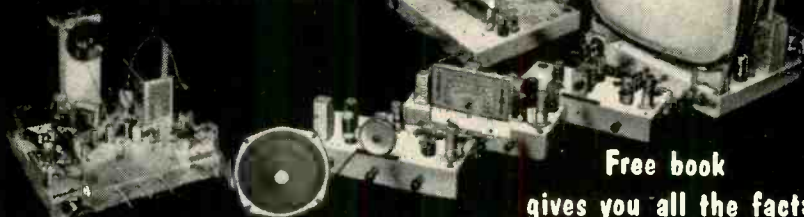

Free book gives you all the facts

## NATIONAL TECHNICAL SCHOOLS

WORLD-WIDE TRAINING SINCE 1905  
4000 SO. FIGUEROA ST., LOS ANGELES 37, CALIF., U. S. A.  
Write Dept. RG-51



### RESIDENT TRAINING AT LOS ANGELES

If you wish to take your training in our Resident School at Los Angeles, the world's TV capital, start NOW in our big, modern Shops, Labs, and Radio-TV Studios. Here you work with the latest Electronic equipment — finest, most professionally installed — finest, most complete facilities offered by any school. Expert friendly instructors. Personal attention. Graduate Employment Service. Help in finding home near school — and part time job while you learn.

WRITE FOR SPECIAL RESIDENT SCHOOL CATALOG AND INFORMATION



ACCREDITED MEMBER... the only nationally recognized accrediting agency for private home study schools.

N.T.S. Shop-Tested HOME TRAINING is Better, More Complete, Lower Cost... and it is your key to the most fascinating, opportunity-filled industry today!

### YOU LEARN QUICKLY AND EASILY THE N.T.S. SHOP-TESTED WAY

You get lessons, manuals, job projects, unlimited consultation, graduate advisory service. You build a Short Wave-Long Wave Superhet Receiver, plus a large-screen TV set from the ground up, with parts we send you at no addi-

tional cost. You also get a Professional Multitester for your practical job projects.

### EARN AS YOU LEARN... WE SHOW YOU HOW!

Many students pay for entire tuition — and earn much more — with spare time work they perform while training. You can do the same... we show you how.

SEND FOR INFORMATION NOW... TODAY! IT COSTS YOU NOTHING TO INVESTIGATE.

### N.T.S. HOME TRAINING is

- Classroom Developed
- Lab-Studio Planned
- Shop-Tested
- Industry-Approved
- Specifically Designed for Home Study



MAIL COUPON NOW for FREE BOOK and ACTUAL LESSON

NO OBLIGATION! NO SALESMAN WILL CALL

## NATIONAL TECHNICAL SCHOOLS

WORLD-WIDE TRAINING SINCE 1905

Mail Now To  
National Technical Schools, Dept. RG-51  
4000 S. Figueroa St., Los Angeles 37, Calif.  
Please rush FREE Electronics-TV-Radio "Opportunity" Book and Actual Lesson. No Salesman will call.

Name \_\_\_\_\_ Age \_\_\_\_\_  
Address \_\_\_\_\_  
City \_\_\_\_\_ Zone \_\_\_\_\_ State \_\_\_\_\_  
 Check here if interested ONLY in Resident Training at Los Angeles.  
VETERANS: Give date of discharge \_\_\_\_\_

# News Briefs

## New Color Tube Is Brighter

Up to 50% greater brightness is claimed for the new RCA color picture tube developed by the Electron Tube Div. at Lancaster, Pa. Improved phosphors of the sulfide type are credited with the new improvement. A better color balance achieved by matching the high-efficiency phosphors, and sharper pictures of rapid-action scenes obtained by shorter phosphor persistence are other features of the tube.

RCA officials point out that the new tube will make color TV practical in public places where high room lighting previously made it impractical, as well as making it easier for dealers to demonstrate in the usually well lighted showroom. The tube is being furnished to manufacturers in either the conventional type which uses a regular safety glass or in the laminated safety-plate type which does not need any additional protection.

## TV Pix to Come from Moon

The Surveyor spacecraft, recently ordered from the Hughes Aircraft Co. by the National Aeronautics and Space Administration, will carry no less than four TV cameras to send pictures of the moon's surface back to the earth.

The Surveyor will weigh 2,500 pounds when the Centaur rocket

which sends it on its way to the moon falls away. After its retro rocket, which cushions the landing, burns out, it will weigh 750 pounds, of which more than 200 will be scientific equipment. The "soft" moon landing is expected to take place at about 6 miles per hour. Besides the TV instruments, Surveyor will carry a seismometer, magnetometer, gravity-measuring equipment, a drill designed to penetrate the surface to a depth of 5 feet, and instruments to measure radiation and the lunar atmosphere.

## Vhf Translators Start Work

Translators K3AA and K13AA, both at Mexican Hat, Utah, began to repeat the programs of KGGM-TV and KOB-TV, Albuquerque, N. M., about the middle of February. They were the first under the FCC's vhf booster rules. Transmitters were supplied by Blonder-Tongue's Benco Div. Over 900 permits were issued to existing boosters, permitting them to continue in operation while their equipment is modified to meet FCC standards for vhf translators.

## Smog Kills Higher Frequencies

Microwave signals over an 11.4-mile line-of-sight path, which came in perfectly on clear days, faded and disappeared on days when temperature-inversion-caused smog pre-

veiled, California engineers discovered. The experiment was set up between the Los Angeles City Hall and the UCLA physics building. Signals at 36,000 mc (36 gigacycles) and higher faded, at times completely, especially when the inversion layer was below 1,000 feet and while the sun was rising.

The practical importance of the work is in setting an upper frequency limit for radio transmission during smoggy weather. Frequencies below 36,000 mc may be considered reliable. A less important result is the discovery that microwaves are a fast method of measuring the height of an inversion layer, especially when between 500 and 1,000 feet.

## RCA Makes "Dark Heater" Tube

Development of a new tube that operates at temperatures 20% lower than those necessary with conventional heaters was announced recently by the RCA Electron Tube Div. The new tubes get their name from the gray insulation coating on the heater wire. They operate 350°K below the 1,500 to 1,700° Kelvin of the conventional white heater.

More than a quarter million of the new tubes have been produced to date, and they will be used in a wide variety of receiving tubes within the next few months. They are expected to reduce the effects of ac leakage and hum, cut down the possibility of heater damage and shorts due to changes in heater shape during warming and cooling, and maintain stable current characteristics throughout a "greatly extended tube life."

## Lescarbourea Honored

Austin C. Lescarbourea, one of the pioneers in the electronics and electronic publishing fields, was tendered a testimonial dinner by more than 120 leaders of the electronics industry early this year. The dinner concluded with talks by a dozen of his old associates, and he was presented with a color TV receiver and a silver tray engraved with the signatures of the speakers.

Austin Lescarbourea was one of the earliest editors of Gernsback publications, having started in 1910 in Gernsback's Electro Importing Co., shortly thereafter becoming associate editor and later editor of *Modern Electrics*. Continuing with *Modern Electrics* when it left the

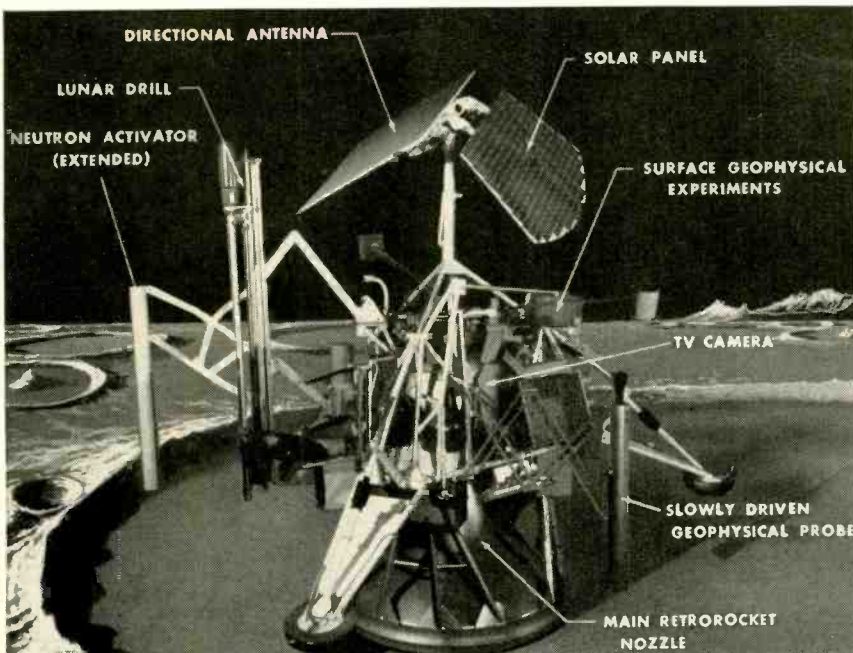

Artist's idea of the Surveyor in action on the moon.

**In Spare Time at Home . . . PREPARE FOR A BETTER JOB  
 . . . OR YOUR OWN BUSINESS in One of Many Branches**

# of **ELECTRONICS**

**RADIO - TELEVISION - RADAR**

**NEW!  
 NEW!  
 NEW!**

Shown above is the valuable new combination oscilloscope and voltmeter which DeVry Tech men build during the new training program. But that's not all! New movies, new experimental projects—all prepare you thoroughly in this latest and greatest DeVry Tech training program.



**21 INCH**

Build and keep this BIG DeVry Engineered TV set — easily converted to U.H.F. (optional training feature at moderate added cost.)

If you are seeking a better job or a business of your own, the appealing field of Television-Radio-Electronics offers **REAL PROMISE!**

In this fast-growing field, trained Electronic technicians find many good-paying, interesting jobs in manufacturing, installing, operating, servicing. Equally important is the fact that these are **GOOD JOBS**—offering the kind of a future that an untrained man often dreams about.

No previous technical experience or advanced education needed. Prepare for this profitable field in your spare time at home, or in our modern Chicago or Toronto Laboratories. Nothing else like it! Send for **FREE** details.

**EARN WHILE YOU LEARN!**

After you get part of DeVry Tech's training with equipment at home, you may then in your spare time, begin to earn real money servicing Radio and Television sets.

**Your Guide to Profitable Job Opportunities!**

- TV-Radio Broadcast Technician
- Color Television Specialist
- Radar Operator • Laboratory Technician
- Airline Radio Man • Computer Specialist
- Missile Electronics Technician
- Your Own Sales & Service Shop
- . . . **PLUS MANY OTHERS**

**HOME MOVIES**



. . . make important points crystal clear. Speeds your learning. It's almost like having an instructor at your side!

**COLOR TV**

DeVry Tech's program also includes training in Color Television

**MILITARY SERVICE**

If you are subject to military service, the information we have should prove very helpful. Mail coupon today.

**YOU ALSO GET . . .** the same **EMPLOYMENT SERVICE** that has helped thousands of our graduates toward fine careers in Electronics.

You work over **300** Learn-By-Doing projects

Build over 300 practical projects from many shipments of Radio-Electronic parts. You build and operate TV-Radio projects... wireless microphone... and many other major projects—all designed to provide outstanding practical experience at home.

**Send for 2 FREE Booklets Now!**

Accredited Member of National Home Study Council  
 "One of North America's Foremost Electronics Training Centers"



**ACT NOW!** Get information-packed publication **FREE!** Mail coupon today.

**DeVRY TECHNICAL INSTITUTE**  
 4141 Belmont Ave., Chicago 41, Ill., Dept. RES-R  
 Please give me your two **FREE** booklets, "Pocket Guide to Real Earnings" and "Electronics In Space Travel"; also include details on how to prepare for a career in Electronics.

Name \_\_\_\_\_ Age \_\_\_\_\_  
 PLEASE PRINT  
 Street \_\_\_\_\_ Age \_\_\_\_\_  
 City \_\_\_\_\_ Zone \_\_\_\_\_ State \_\_\_\_\_

For details of Canadian Training Programs, address DeVry Tech of Canada, Ltd., 970 Lawrence Avenue West, Toronto 19, Ontario

2044-A

**DeVRY TECHNICAL INSTITUTE**

**CHICAGO 41, ILLINOIS**

# Where

# does he

# buy

# his

# clothes?

(His low voltage

ceramic capacitors

are clearly from

# Centralab

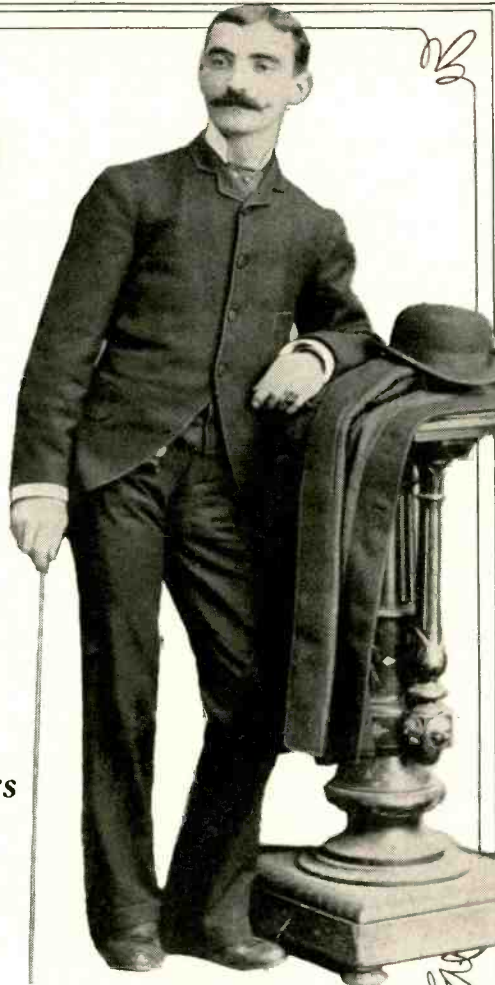
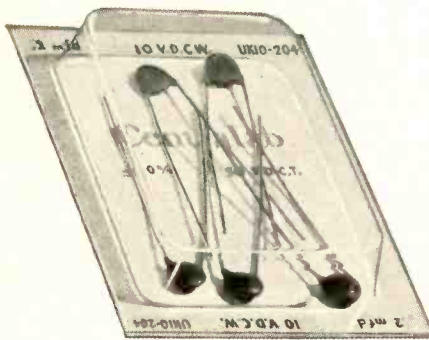

PHOTO: BETTMAN ARCHIVE

You'll look long and hard in today's men's stores to duplicate this outfit—but for ceramic capacitors for transistor circuits, there's a ready source: your CENTRALAB distributor.

There's nothing old-fashioned about CENTRALAB's ceramic capacitor line, except the quality. The styles are up to date, and there's a complete range of sizes, capacitances, and voltages, so you can rely on CENTRALAB for those "hard-to-fit" applications.

For every low voltage application, your CENTRALAB distributor has the ceramic capacitor you need. Ask him for your free copy of CENTRALAB's Catalog 31, which gives complete listings on 3 V and 10 V Ultra-Kaps<sup>®</sup>, 30 V DA Series, 75 V DDA Series, and 150 V DM and DDM Series.



D-6109 S

## Centralab

THE ELECTRONICS DIVISION OF GLOBE-UNION INC.  
922E EAST KEEFE AVENUE • MILWAUKEE 1, WISCONSIN  
CENTRALAB CANADA LIMITED—AJAX, ONTARIO

ELECTRONIC SWITCHES • VARIABLE RESISTORS • CERAMIC CAPACITORS

PACKAGED ELECTRONIC CIRCUITS • ENGINEERED CERAMICS



Gernsback fold, he remained editor as the magazine took over *Electrician and Mechanics* of Boston and *Popular Electricity* of Chicago, becoming successively *Modern Mechanics*, *The World's Advance*, and *Popular Science*. Resigning at that time, Mr. Lescarboursa joined *Scientific American*, where he remained as associate and later as managing editor till 1924, resigning to engage in freelance writing. The next year he started his own publicity agency, which as a publicity and advertising agency is now under the active management of his son Stanley.

Lescarboursa has written a number of books, best-known of which are *Radio for Everybody* (1921) and *This Thing Called Broadcasting*, written in collaboration with Dr. Alfred N. Goldsmith in 1931.

Among those paying tribute to Lescarboursa were Allen B. Du Mont and Hugo Gernsback. Some of the speakers had journeyed some distance to the New York dinner. These included Charles Golenpaul of Aerovox, New Bedford, Mass.; Victor Mucher of Clarostat, Dover, N. H., and Tore Lundahl of Taco, Sherburne, N.Y.

### Lady Amateurs Gather

Annual Midwest YL Amateur Convention, sponsored by the Ladies Amateur Radio Klub of Chicago (LARKS), will be held May 19 and 20, at Weller's Motor Lodge, 6450 W. Touhy Ave., Chicago. The FCC has issued the call W9YL for use during the convention. It will operate on all bands with a complete 1-kw SSB station loaned by Hallcrafters.

### Microscope Shoots "Live"

An electron microscope developed by Prof. Gaston Dupuoy of the Toulouse Electron Optics Laboratory can be used on living bacteria. Previous instruments, into which the bacteria had to be inserted before the microscope was pumped for each setup, killed the bacteria by drying them out as the tube was pumped out to produce the necessary vacuum.

Professor Dupuoy protects the bacteria by sealing them in an air-filled cell separated from the vacuum by two thin layers of collodion. Since the ordinary 50 kilovolts of an elec-

(Continued on page 14)



# NEW knight-kits®

A PRODUCT OF ALLIED RADIO

## - simply great!

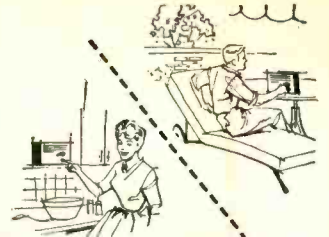

measures engine speed, 0-8000 rpm



it's WIRELESS—just plug in and TALK!

### New Money-Saving Electronic Tachometer Kit

Most Accurate at this Low-Cost—Unaffected by Temperature

**ONLY \$19.95** Another KNIGHT-KIT first—a precision tachometer in money-saving, easy-to-build form. Helps you drive at your best engine speed efficiency, like the professionals. Temperature-compensated Zener diode regulator contributes to exceptional 5%-of-full-scale accuracy, regardless of voltage or temperature changes. Operates with 4, 6 or 8 cylinder automotive engines; simple 3-wire installation. Universal mount fits dash or steering column. Ideal also for high-powered outboard marine engines using primary ignition system from 2 cycle 2 cylinder and up. Big illuminated D'Arsonval meter; linear 0-8000 rpm scale; reference pointer may be preset to any desired speed. With cables, mounting hardware, wire and solder. Shpg. wt., 2 lbs.

83 Y 944. Only \$2 Down. NET. . . . . \$19.95

### Deluxe Wireless Intercom Kit at Lowest Cost

Works Anywhere Without Wires—No Installation!

**ONLY \$18.95** This easy-to-assemble intercom operates without installation or wiring—just plug into any AC or DC wall outlet for step-saving communication! Change locations easily—anywhere. Ideal for home, office or store. In the home, you can communicate with nursery, garage, basement or patio. In office or shop, provides time-saving communication. Will operate between adjacent buildings that are on same electric-company line transformer. Perfect for baby sitting. Features power-line noise silencing circuit for absolutely quiet "standby"; premium quality throughout. Has Talk-Listen switch, with lock-on feature for constant listening. Handsome cream-toned plastic cabinet, 9 x 5½ x 5½". Can be used in systems consisting of 2 or more units, as desired. Shpg. wt., 3½ lbs. 83 Y 941. NET. Each Station . . . . . \$18.95 20 YX 272-2. Complete 2-Station System. NET. . . . . \$36.95

## BIG SAVINGS ON KITS in Allied's Summer Sale Book!



**KN-3000 AK Electrostatic Speaker System Kit**  
**Save \$25.00** Regularly \$99.50—Summer Sale price slashed to \$74.50! Finest high-compliance speaker system delivering absolutely fabulous sound. Includes 12" extra-low resonance woofer; two patented Arthur Janszen electrostatic tweeters; premium quality power supply (pre-wired); hardwood panels for building sealed enclosure, Korina veneer panels (unfinished) for external surfaces; acoustic damping material. Assembled size, 14 x 26½ x 13". Response, 30-25000 cps. Capacity, 50 watts music waveform. Shpg. wt., 50 lbs.  
 35 DU 767. Only \$5 Down. NET. . . . . \$74.50

### C-27 Citizens Band Transceiver Kit with Press-to-Talk Microphone

**Save \$5.00** Combination regularly \$89.45—now reduced to \$84.45! Genuine dual-conversion superhet receiver for highest sensitivity and selectivity; 2-channel crystal-controlled full 5-watt transmitter. Features: Automatic noise limiter; continuously variable squelch control. With one transmitting crystal (channel 1-22—specify). Includes quality Press-to-Talk Microphone. Shpg. wt., 21 lbs.  
 20 YU 271-3. Only \$5 Down. NET. . . . . \$84.45



**FREE!**

Send for the big bargain-packed Allied Summer Sale Book—save as never before on everything in Electronics!

Send for it!



ALLIED RADIO, Dept. 68-E1  
 100 N. Western Ave., Chicago 80, Ill.

Please ship me the following:

- 83 Y 944 Tachometer Kit.  83 Y 941 Intercom Station.
- 35 DU 767 Speaker Kit.  20 YX 272-2 Intercom System.
- 20 YU 271-3 Transceiver with Mike. \$\_\_\_\_\_ enclosed
- Send Free Allied Summer Sale Book No. 205

Name \_\_\_\_\_  
 PRINT  
 Address \_\_\_\_\_  
 City \_\_\_\_\_ Zone \_\_\_\_\_ State \_\_\_\_\_

order from **ALLIED RADIO**



The Businessman in the Serviceman suit is aware that color TV sales will sky-rocket in 1961\*. He realizes *every* color TV owner is a prime *antenna* prospect. That's why he recommends a JFD Hi-Fi TV antenna installation for fidelity color reception as well as best black and white. It delivers the picture that viewers pay for... earns him the prestige and profits he is in business for.

\*For all 1961 sales of color receivers will top 200,000 units. — Wall Street Journal

THE BRAND THAT PUTS YOU

# JFD

IN COMMAND OF THE MARKET

JFD ELECTRONICS CORPORATION  
BROOKLYN 4, NEW YORK

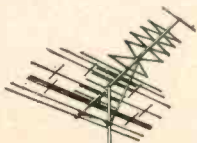

HI-FI HELIX

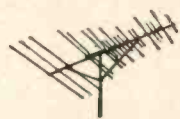

HI-FI BANSHEE

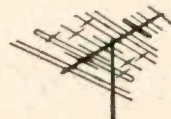

HI-FI FIREBALL

# how to get a Commercial FCC LICENSE

## An FCC License, Or Your Money Back!

Completion of the Master Course (both Sections) will prepare you for a First Class Commercial Radio Telephone License with a Radar Endorsement. Should you fail to pass the FCC examination for this license after successfully completing the Master Course, you will receive a full refund of all tuition payments. This guarantee is valid for the entire period of your enrollment agreement.

### Get This Handy Pocket Electronics Data Guide

**Free**

Puts all the commonly used conversion factors, formulas, tables, and color codes at your fingertips. Yours absolutely free if you mail the coupon today. No further obligation.

**FREE**



find out how . . .

1. You can handle the new electronic devices.
  2. You can solve the problems that stump your fellow technicians.
- Training is Job Insurance when employment is tough to find . . . and more money for you when times are good.
- 3.

### CLEVELAND INSTITUTE OF ELECTRONICS

1776 E. 17th St. Desk RE53A Cleveland 14, Ohio

MAY, 1961

Mail  
Coupon  
NOW!



good training  
doesn't cost . . .  
it pays!

get all three **FREE!**

### Increase Your Technical Knowledge

Get a government license plus an understanding of such electronic applications as computers . . . industrial electronics . . . radar . . . communications . . . and many more.

### Not For Beginners

Please inquire only if you really want to get ahead and to add to what you have already learned in school, in the service, or on the job. Some previous schooling or experience in electronics, electricity, or related fields is necessary for success in Cleveland Institute programs.

Accredited by the National Home Study Council

### Cleveland Institute of Electronics

Desk RE53A, 1776 E. 17th St., Cleveland 14, Ohio

Please send Free Career Information prepared to help me get ahead in Electronics. I have had training or experience in Electronics as indicated below.



- |   |   |
|---|---|
| <input type="checkbox"/> Military           | <input type="checkbox"/> Broadcasting       |
| <input type="checkbox"/> Radio-TV Servicing | <input type="checkbox"/> Home Experimenting |
| <input type="checkbox"/> Manufacturing      | <input type="checkbox"/> Telephone Company  |
| <input type="checkbox"/> Amateur Radio      | <input type="checkbox"/> Other _____        |

In what kind of work are you now engaged?

In what branch of Electronics are you interested?

Name \_\_\_\_\_ Age \_\_\_\_\_

Address \_\_\_\_\_

City \_\_\_\_\_ Zone \_\_\_\_\_ State \_\_\_\_\_

RE53A

# IT COULD HAPPEN TO YOU...



Somewhere it said: "Build this kit in an amazing 10 hours!" Looks like you're running into overtime because you spent the first 7½ hours sorting out the jumbled mess of small parts and hardware. Well, it's good training for looking for needles in haystacks.



If drug manufacturers made the mistakes in labeling you find in some kits, the world would be a quieter, lonelier place. You know a selenium rectifier when you see one, and if this is a selenium rectifier, you're Thomas Alva Edison.



Let's see. On Page 5 it says; "See diagram Page 12." On Page 12 it says; "See instructions Page 5." Well, if you hold Page 5 open with your tongue, and Page 12 open with your left ear, that still leaves you three fingers on your left hand free for soldering and also...



Don't look now, but while Heifetz fiddles, your amplifier burns. When the smoke clears, you'll probably find that the 100 microfarad electrolytic was shorted because it had not been pre-tested. All work and no play, makes Jack a very mad boy!

# UNLESS THE KIT YOU BUILD IS A PACO

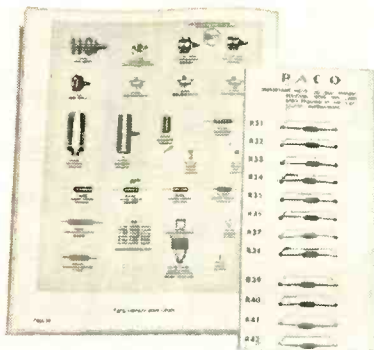

No mistaken identity or endless searching. Parts are clearly pictured and labeled; resistors are neatly mounted and identified!

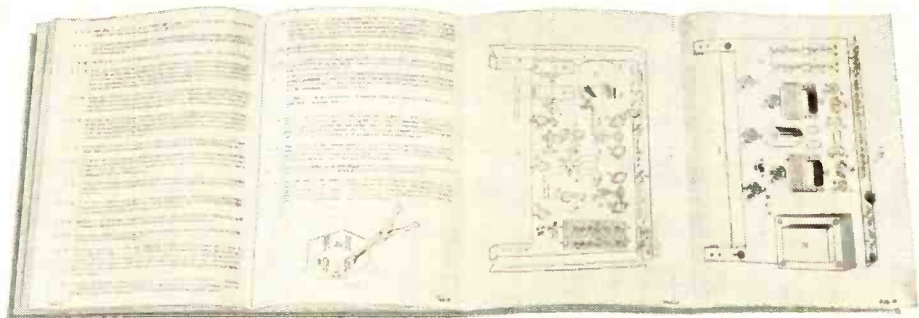

Step-by-step instruction book makes assembling a Paco Kit foolproof! Paco gives you giant, fold-out diagrams on corresponding instruction pages so you can see both at the same time.



## PACO Model C-25 IN-CIRCUIT CAPACITOR TESTER KIT

Reveals dried out, shorted, or open electrolytics—in the circuit—with Paco's exclusive Capacity Dial. Instantly finds open or direct shorted capacitors without removing from circuit. Great time saver!

### Specifications:

**SIMPLE SEQUENTIAL TEST:** reveals open or shorted capacitors, including electrolytic types.

**ELECTROLYTIC DIAL:** indicates actual electrolytic values while capacitor is in-circuit; any electrolytic which yields a capacity reading on Electrolytic Dial is automatically revealed as not open or shorted.

**ELECTROLYTIC TEST:** indicates in-circuit electrolytic capacity from 2 mfd to 400 mfd in two ranges; condenser is automatically proved non-shortened and not open if Capacity Reading can be obtained.

Model C-25: Kit, complete with PACO-detailed assembly-operating manual. Kit Net Price: \$19.95

Model C-25W: Factory-wired, ready to operate. Net Price: 29.95



## PACO Model DF-90 TRANSISTORIZED DEPTH FINDER KIT

Protect your boat against shoals and underwater hazards with this compact, easy-to-read depth finder. Transistors prolong battery life, provide utmost accuracy and portability. A boon to fishermen—locates hard-to-find schools of fish. A low cost safety device for every boat owner.

### Specifications:

**FULLY TRANSISTORIZED:** 5 transistors, with a low battery drain for extremely long battery life.

**HIGH INTENSITY INDICATOR:** for sensitive, accurate response under all conditions.

**FAST, EASY READINGS:** made possible by means of over-sized scale calibrated at one-foot intervals from 0 to 120 feet.

Model DF-90: Kit, complete with PACO-detailed assembly-operating manual. Kit Net Price: \$84.50

Model DF-90W: Factory-wired, ready to operate. Net Price: \$135.50

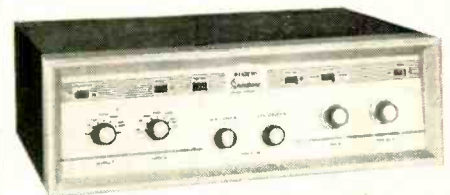

## PACO Model SA-40 STEREO PREAMP-AMPLIFIER KIT

Assemble a superb home music system with this true 40 watt stereo preamp-amplifier. Unmatched flexibility, less than 0.5% distortion, and handsome design make this the ideal component for music lover and audiophile alike!

### Specifications:

**MUSIC WAVEFORM POWER OUTPUT:** 25 watts per channel (50 watts total).

**RESPONSE:** 30 cps to 90Kc,  $\pm 1.0\%$  db

**HARMONIC DISTORTION:** less than 0.5% at 20 watts per channel output.

Model SA-40: Kit, complete with black and gold case and PACO-detailed assembly-operating manual. . . . . Kit Net Price: \$79.95

Model SA-40W: Factory-wired, with black and gold case, ready to operate. Net Price: \$129.95

## FREE! COMPLETE ILLUSTRATED CATALOG

Mail this coupon for the complete Paco catalog of electronic equipment kits, including test instruments, measuring instruments, and high fidelity components.

**PACO KITS BY PACOTRONICS, INC.**

Paco Electronics Company, Inc., DEPT. RE-5  
70-31 84th Street, Glendale 27, L. I., N. Y.  
Please send me your complete illustrated catalog.

Name .....

Address .....

City..... Zone..... State.....

©PACOTRONICS, INC. 1961

# SERVICE MASTER... EVERY TOOL YOU NEED 99% OF THE TIME



complete 23-piece kit for radio, TV,  
and electronic service calls

## 2 HANDLES:

shockproof plastic. Regular 4" length... 2" Stubby. Interchangeable. Patented spring holds snap-in tools firmly in place.



## 9 NUTDRIVERS:

High Nickel chrome finish, 3/16" to 1/2"

## 3 STUBBY NUTDRIVERS:

1/4", 5/16", 3/8"



## EXTENSION BLADE:

Adds 7". Fits both handles.



## 3 SCREWDRIVERS:

Two slotted... 3/16", 1/4", #1 Phillips



## 2 REAMERS:

1/8-3/8", 1/4-1/2"



## ADJUSTABLE WRENCH:

6" thin pattern, 1" opening



## LONG NOSE PLIER:

"Cushion Grip", 2 1/4" nose



## DIAGONAL PLIER:

"Cushion Grip", hand-honed cutting edges

## ROLL UP KIT:

Durable, plastic-coated canvas. Compact, easy-to-carry.

Ask your distributor to show you kit 99 SM

# XCELITE

XCELITE, INC. • ORCHARD PARK, N. Y.  
Canada: Charles W. Pointon, Ltd., Toronto, Ont.

(Continued from page 8)

tron microscope would be stopped by the two collodion layers added to the thickness of the specimen, Dupuy shot beams of million-volt electrons in pulses. These made satisfactory pictures without harming the bacteria. The result is pictures of living organisms, rather than those of dried-up husks that were made with the ordinary electron microscope.

## Correction

In the item "Electricity Replaces Ether" on page 6 of the March issue, the statement was made that the work took place in the University of Michigan. Actually it took place at the University of Mississippi Medical Center. RADIO-ELECTRONICS regrets this misprint, which was called to our attention by a number of readers.

## Zenith Will Make Color TV

Announcing that it will make color TV receivers for the fall market, Zenith says its line will be "completely new and unique." Complete details of the proposed innovations will not be revealed till the sets are on the market, but it is learned that the picture tube will be the new RCA three-gun shadow-mask type (page 6). The color demodulation system will employ a new tube invented by Zenith scientists, however.

Horizontal chassis design and hand-wired circuitry will prevail in the new color sets, Zenith states.

## FCC Asks Uhf for All TV's

The Federal Communications Commission proposes Congressional legislation to make all new TV receivers usable on the uhf as well as the vhf band. This, the commission believes, would make the introduction of uhf much easier in areas where uhf stations may be established in the future, as well as improve the situation of uhf stations now operating in areas where there are both vhf and uhf transmitters. The cost of including all-channel coverage in a receiver, Commissioner F. W. Ford estimated, would be about \$10 per unit. An added converter to a vhf set usually costs more, plus installation charges and the inconvenience of an additional piece of equipment.

## Transistor Hits 5 Gigacycles

A laboratory prototype transistor has been measured at a maximum oscillation frequency of 5,000 megacycles, the Lansdale Div. of Philco reports.

The transistor was an MADT (micro-alloy diffused-base transistor) with a gain of 14 db at 1,000 mc and 21 db at 420 mc, with noise figures of 8 and 4 db, respectively.

The performance of the new transistor is due to careful attention to electrode geometry, according to Dr. C. G. Thornton, Lansdale's director of research and development. He

explained that electrodes of approximately 1.5 mils in diameter and a base width of .03 mil have been used. These factors, he said, plus an increase in surface concentration in the region immediately adjacent to the edge of the emitter have permitted a 2-to-1 reduction in the level of high-frequency base resistance.

## Calendar of Events

- IRE Electronic Components Conference, May 2-4, Jack Tar Hotel, San Francisco, Calif.
- IRE Symposium on Human Factors in Electronics, May 4-5, Marriott-Twin Bridges Motor Hotel, Arlington, Va.
- IRE Midwest Symposium on Circuit Theory, May 8-9, Allerton Park & Urbana Campus, University of Illinois.
- IRE National Aerospace Electronics Conference, May 8-10, Biltmore and Miami hotels, Dayton, Ohio.
- IRE-AIEE Western Joint Computer Conference, May 9-11, Ambassador Hotel, Los Angeles, Calif.
- IRE Microwave Theory & Techniques Symposium, May 15-17, Sheraton Park Hotel, Washington, D.C.
- IRE-AIEE Global Communications Symposium, May 22-24, Hotel Sherman, Chicago, Ill.
- IRE-AIEE National Telemetering Conference, May 22-24, Sheraton Towers Hotel, Chicago, Ill.
- 1961 Electronic Parts Distributor Show, May 22-24, Conrad Hilton Hotel, Chicago, Ill. (Attendance limited to manufacturers and their advertising agencies, representatives and distributors) Radio-Electronics will exhibit in room 610.
- EIA Annual Convention, May 24-26, Pick-Congress Hotel, Chicago, Ill.
- British Radio and Electronic Component Manufacturers' Federation Show, May 30-June 2, Olympia, London, England.
- Instrument Society of America Conference and Exhibit, June 5-8, Royal York Hotel and Queen Elizabeth Hall, Toronto, Canada.
- IRE National Symposium on Radio-Frequency Interference, June 12-13, Sheraton Park Hotel, Washington, D. C.
- IRE National Conference on Broadcast & Television Receivers, June 19-20, O'Hare's Inn, Des Plaines, Ill.

## Teletype for Your Car

A communication system that types messages received by radio in a moving car or boat has been announced by Goodyear Aircraft Co., Litchfield Park, Ariz. The message is typed on a cigar-box-size teletypewriter transmitter in the office (or home) and can be transmitted over a range of about 20 miles. The battery-powered receiver and teletypewriter weighs 20 pounds. Speed is 120 letters a minute. The unit was developed for the military, but Goodyear foresees many applications.

## FAA Pushes Air Safety

The Federal Aviation Agency has acquired five airplanes to use for monitoring the accuracy of aerial navigation signals, in a semi-automatic flight-check system that will make it possible to make sure in a fraction of the time now required that navigation signals are right.

The planes will be flown on grid patterns while multiple receivers are tuned to ground stations on each side of the path.

The agency also reports a successful test of a new three-dimensional radar unit. Built recently at the agency's research center in Atlantic City, N. J., it is expected to reduce the danger of mid-air collisions. END



# OMNIDIRECTIONAL

**ELECTRO-VOICE MODELS 636 AND 630** eliminate critical placement . . . assure remarkable fidelity. Omnidirectional from all points.

For truly uniform microphone response—for slim-trim case styling—for complete application versatility, the Electro-Voice Model 636 Dynamic is unsurpassed. Designed especially for public address and general purpose applications, the Model 636 blends easily, unobtrusively into PA stagings, eliminating placement problems and improving audience enjoyment. The baton design provides a convenient, easy-to-handle shape for hand carrying. This modern, streamlined model measures only 1 1/4 inches in diameter, yet provides output levels equal to microphones four times as large. *Other Features:* Exclusive E-V Acoustalloy diaphragm. Adaptable to either high or low impedance inputs; convenient ON-OFF switch for instant control; uniform response from 60 to 15,000 cps; wire mesh grille to minimize wind and breath blasts; tiltable through 90° arc toward sound source. List price (less stand). Satin Chromium Finish—\$72.50; Gold Finish—\$77.50.

Omnidirectional also describes the performance of the popular Electro-Voice Model 630 Dynamic Microphone. Designed by the same top acoustical engineering talent that developed the slim Model 636, this versatile microphone also provides optimum performance for an unusually wide range of professional, commercial, and personal applications. An exceptionally rugged instrument, the Model 630 may be mounted on a floor or desk stand or it may be hand held. List Price (less stand) \$52.50.

Complete specifications available upon request. For a trial demonstration of either of these fine, omnidirectional microphones, visit your Electro-Voice dealer—today.



MODEL 630

**Electro-Voice**®

Commercial Products Division  
ELECTRO-VOICE, INC.

Dept. 512E Buchanan, Michigan

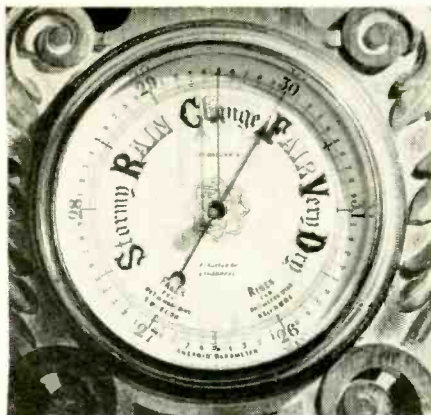

**sensitive**



**responsive**



**good-looking**

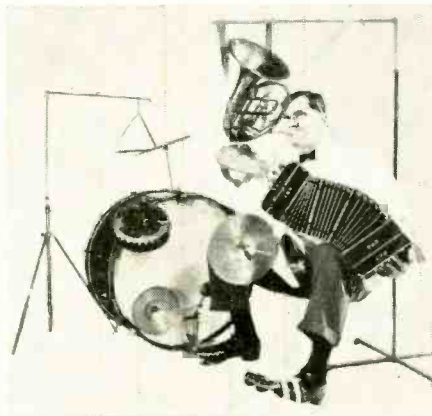

**versatile**

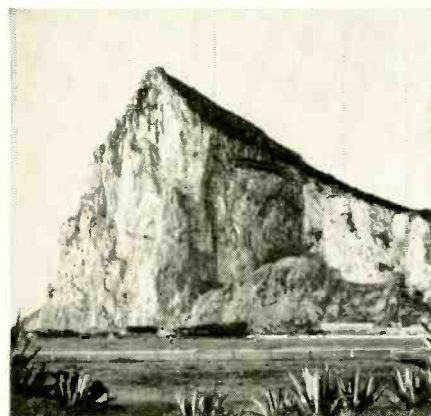

**dependable**



**rugged**

# That's a University Modular Microphone!

**...the dynamic professional microphone with dynamic performance... dynamic features... dynamic styling.**

And there's a dramatic story behind this new line of omnidirectional, cardioid and lavalier microphones... the complete inside story that every professional sound man should read.

It's yours, free. Just write to Desk J-5, University Loudspeakers, Inc., 80 South Kensico Avenue, White Plains, New York.



## Correspondence



### THAT METER EXPANDER

Dear Editor:

In my article "Make Your Meter Easier to Read" which appeared in the February 1961 issue of RADIO-ELECTRONICS, I described a circuit for expanding the range of ac voltmeters.

A few of your readers have written, some asking for more information about the results to be expected, others stating that the setup could not work.

In the article I stated that the circuit makes it possible to note minute "changes in line voltage" accurately.

When a pair of OB2 V-R tubes are connected in reverse parallel as described in the article, the ac meter is connected across the resistor in series with the V-R tubes. The meter measures the voltage drop across the resistor. This drop is a function of V-R current flow, which rises as the line voltage being measured, and vice versa.

If the current through the resistor were a true sine wave, the voltage drop across the resistor could be measured as an rms value. However, the current is not sinusoidal because the tubes do not fire during their respective cycles until a certain voltage is reached.

Nevertheless, the queer waveform is such that the reading obtained with a rms voltmeter is close to the rms value. Using an Argonne AR-660 vom, I found the line voltage to be 130, the drop across the V-R tubes 105 volts, and the drop across the resistor 25 volts.

Using a vtvm, I got higher readings.

I also looked at the waveform with a Scopes Inc. laboratory-grade oscilloscope and concluded that with a peak-reading voltmeter (vtvm) you should get a too-high reading, but with an rms type conventional voltmeter you should get a reading close to the rms value. The high peaks are offset by the relatively long periods of zero current (when V-R tubes are not conducting). The composite result is a current which is higher than the rms value, but for a period of less than a half-cycle in each direction.

LEO G. SANDS

Ridgewood, N. J.

[RADIO-ELECTRONICS received a large number of letters on the subject, ranging from a flat statement that the OB2 has a reverse voltage of 50 and won't work to "... to summarize, the circuit... may be used to determine line voltage to a higher degree of accuracy than



Through  
**HOME STUDY**  
or in  
**RESIDENT CLASSES**

# ELECTRONICS

— field of opportunity —

the Grantham Communications  
Electronics Course prepares you  
for your first class commercial  
**F.C.C. LICENSE**

The Grantham home study course teaches you principles of electronics in a simple "easy-to-grasp" manner. Each new principle is explained first in *everyday language* and then, after you understand it, is associated with the proper *technical language*. You learn and remember more, because the emphasis is on *understanding* rather than on memorizing.

This correspondence course is directed toward two major objectives—(1) to *teach* you a great deal about electronics, and (2) to prepare you to *pass* all of the F. C. C. examinations required for a first class commercial operator's license. We teach you step by step and have you practice with FCC-type tests which you send to the School for grading and comment. You prepare for your F. C. C. examinations under the watchful direction of an instructor who is especially qualified in this field.

Grantham training is the easy way to learn more quickly—to prepare more thoroughly—for F. C. C. examinations. And your first class license is the quick, easy way to prove to your employer that you are worth more money.

Get details concerning *how* we can prepare you for your F. C. C. license and *how* that license can help you advance in electronics. Mail the coupon below to the home office of Grantham School of Electronics in Hollywood, Calif., and our free catalog will be sent to you promptly.

offers

interesting and profitable careers in

RADIO AND TV BROADCASTING • TWO-WAY RADIO COMMUNICATIONS • RESEARCH AND DEVELOPMENT • RELAY STATION MAINTENANCE • AUTOMATION ELECTRONICS • TECHNICAL WRITING IN ELECTRONICS • INDUSTRIAL ELECTRONICS • ELECTRONIC COMPUTERS • MILITARY ELECTRONICS • INSTRUMENTATION • TELEMETERING • AERONAUTICAL ELECTRONICS • SPACE ELECTRONICS

and many other

interesting and profitable fields of the present and future

To get ahead in electronics, you must have the proper training and your employer must know that you have that training. Your F. C. C. license is a "diploma" in communications electronics granted by the U. S. Government, and it is recognized as such by employers. Grantham School of Electronics specializes in preparing you to earn this diploma.

**HERE'S PROOF...** that Grantham students prepare for F. C. C. examinations in a minimum of time. Here is a list of a *few* of our recent graduates, the class of license they got, and how long it took them:

	License	Weeks
Don Fenimore, 1305 Ray Street, Dexter, Mo.	1st	12
Jim E. Miller, 8433 12th, S.W., Seattle 6, Wash.	1st	12
Robert R. Constance, 222 Sander St., Pineville, La.	1st	12
Michael J. Flaherty, 5 Wakefield Dr., Trenton, N.J.	1st	12
J. R. Pierce, Jr., Rt. 5, Kingsport, Tenn.	1st	12
Pias B. Jernigan, Rt. 2, Benson, N.C.	1st	12
Gordon Fritsch, Box 122, Edwall, Wash.	1st	12
Bert G. Erickson, P.O. Box 149, Arcadia, Fla.	1st	12
William F. Bratton, Jr., 435 Etna St., Russell, Ky.	1st	12
Allen E. Marsh, 1719 West 57th St., Seattle, Wash.	1st	20
Andy Sams, Box 1066, Statesville, N.C.	1st	13
Richard P. Neal, 2 Carleton Place, Alexandria, Va.	1st	12

If you are interested in details concerning our training, indicate in the coupon below whether you prefer home study or resident classes, and mail the coupon to the School's home office in Hollywood, California—to the address given in the coupon—for free details.

## GRANTHAM SCHOOL OF ELECTRONICS

HOLLYWOOD

SEATTLE

KANSAS CITY

WASHINGTON

### FIRST CLASS F.C.C. LICENSE IN 12 WEEKS

Grantham resident schools are located in four major cities—Hollywood, Seattle, Kansas City, and Washington, D.C. Regularly scheduled classes in F. C. C. license preparation are offered at all locations. New day classes begin every three months, and new evening classes begin four times a year. The day classes meet 5 days a week and prepare you for a first class F. C. C. license in 12 weeks. The evening classes meet 3 nights a week and prepare you for a first class license in 20 weeks. For more information about the Grantham resident schools, indicate in the coupon the city of your choice and then mail the coupon to the School's home office in Hollywood, Calif. Free details will be mailed to you promptly.

**GRANTHAM SCHOOL OF ELECTRONICS**  
1505 N. Western Ave., Hollywood 27, Calif.



(Mail in envelope or paste on postal card)

To: **GRANTHAM SCHOOL OF ELECTRONICS**  
1505 N. WESTERN AVE., HOLLYWOOD 27, CALIF.

Gentlemen:

Please send me your free booklet telling how I can get my commercial F.C.C. license quickly. I understand there is no obligation and no salesman will call.

Name \_\_\_\_\_ Age \_\_\_\_\_

Address \_\_\_\_\_

City \_\_\_\_\_ State \_\_\_\_\_

I am interested in:  Home Study  Kansas City classes  
 Hollywood classes  Seattle classes  Washington classes

14E

MAIL COUPON FOR FREE DETAILS—NO SALESMAN WILL CALL

Quality you can count on  
**EVERY SINGLE TIME!**

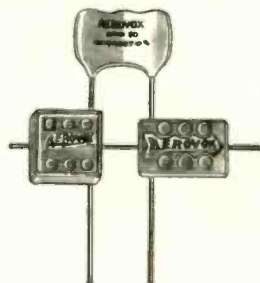

## AEROVOX MICA CAPACITORS

"Trouble-free" best sums up the many advantages in using top-quality Aerovox mica capacitors. Quality isn't a matter of chance—it's a result of engineering and manufacturing know-how gained from years of experience in producing the industry's leading line of capacitors for both initial equipment and replacements.

The superior quality of Aerovox mica capacitors is your best protection against the costliness and inconvenience of premature failures. Yes, it's good to know you can service a set and forget about call-backs.

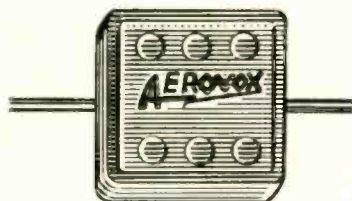

**POSTAGE STAMP MICAS...** for all those applications where only the smallest axial leads will do. Perfect for critical applications such as horizontal or vertical oscillators. All units are color-coded and stamped with capacity value.



**HIGH VOLTAGE MICAS...** designed especially for TV and low power transmitters and power amplifier applications. These top-quality units feature the highest voltages available in these can sizes. Every unit is marked with capacity and working voltage, and tested at double the rated voltage to insure dependable service and long life.



**Plastic-Coated DIPPED MICAS...** superior in many instances to conventional molded units. High operating temperatures, excellent long-life characteristics, ideal for printed-circuit assemblies. Smaller physical sizes with unsurpassed performance and stability features.

AEROVOX mica capacitors are available in a complete range of capacitance values. Your local Aerovox Distributor is your one-step source of supply—call on him for all your capacitor needs. Remember—it pays to use Aerovox!

**AEROVOX CORPORATION**

DISTRIBUTOR DIVISION

NEW BEDFORD, MASSACHUSETTS

offered by the ordinary ac voltmeter. However, the relationship between the voltmeter reading, the regulating voltage of the V-R tube and the ac line voltage is not nearly so simple as Mr. Sands suggests. Furthermore, it is necessary to know the type of ac meter, as well as the exact characteristics of the V-R tubes used."

We found the above statement correct. Mr. Sands' equipment was checked with two sets of OB2's. One set regulated at exactly 105 volts, the other at 95. Varying the voltage with a Variac showed agreement over the normal range of ac voltage variation, when measured with a 20,000-ohms/volt and with a 1,000-ohms/volt meter. The expansion of the scale made it possible to read small changes in voltage easily.

A vtvm gave consistently high readings, and is not suitable for use with this instrument. Deviations from correctness were found as the voltage was raised toward 130 and dropped toward the regulating voltage of the tube. Readings were high in the first case, and low and erratic as the voltage dropped to where the current through the tubes approached zero.

Results indicated that, though the form of the wave departed fantastically from a sine wave, a rectifier type meter measured it accurately and, of course, the spread offered by the expansion made it possible to read the meter much more accurately. It is, however, necessary to calibrate each installation, due to variations in tubes (one correspondent sent in figures based on OB2's that regulated at 108 volts) and meters.]

### IMPEDANCE MATCHING

*Dear Editor:*

I would like to take this opportunity to correct some implications in the March 1961 TV Service Clinic. Concerning the use of signal generators in TV alignment, Mr. Darr states, "If our impedances are matched, we get maximum current flow; therefore we also get maximum voltage drop." This, unfortunately, is not quite the case.

It is true that when the impedances are matched, we deliver to the load impedance the maximum possible power, which will be, as Mr. Darr states, one-half the total power in the circuit. The load voltage, on the other hand, will not be maximum when the load impedance is equal to the source impedance; it will instead be exactly one-half the open circuit terminal voltage of the generator.

It is true that the most efficient transfer of power is made when the impedances are matched, but current is neither maximum under these conditions, nor is voltage. Current will be maximum when the load impedance is zero and voltage when the load impedance is infinite.

Second, concerning the proper termination of signal generator cables when

**AT  
LAST!**

**RADIO-TV and  
ELECTRONICS TRAINING**

**.... AT A PRICE  
YOU CAN AFFORD!**



**\*21 INCH**  
Receiver Kit included

Yes, this great course costs far less than any training of its kind given by other major schools! Radio-Television Training School will train you for a good job in Television or Industrial Electronics — AT HOME IN YOUR SPARE TIME.

Think of it—a complete training program including over 120 lessons, Fourteen Big Radio-Television Kits, Complete Color-TV Instruction, Unlimited Consultation Service . . . **ALL at a really big saving to you.** How can we do this? Write to us today . . . and find out!

And what's more — you can (if you wish)

**OPEN YOUR OWN RTS-APPROVED AND FINANCED RADIO-TV SERVICE SHOP**

**We Want Many More Shops This Year**

This 38 year old training organization — called RTS, that's Radio-Television Training School — wants to establish a string of Radio-TV Repair Shops in principal cities throughout the U. S. So far, a great many such shops are **NOW IN BUSINESS AND PROSPERING.** We are helping and training ambitious men to become future owners and operators of these shops in all areas.

**FOR UNSKILLED  
INEXPERIENCED MEN ONLY —  
WE TRAIN YOU OUR WAY!**

We must insist that the men we sign up be trained in Radio-TV Repair, Merchandising and Sales by our training methods—because **WE KNOW** the requirements of the industry. Therefore, we will **TRAIN YOU . . .** we will show you how to earn **EXTRA CASH**, during the first month or two of your training period. **YOU KEEP YOUR PRESENT JOB. TRAINING TAKES PLACE IN YOUR OWN HOME. IN YOUR SPARE TIME!**

**COMPLETE  
COLOR TV  
INSTRUCTION  
INCLUDED**

**YOU BUILD THESE  
AND OTHER UNITS!**



MULTITESTER  
KIT INCLUDED!

\*tubes  
excluded

**RADIO-TELEVISION  
TRAINING SCHOOL**

815 E ROSECRANS AVENUE  
LOS ANGELES 59, CALIFORNIA

Est. 1922

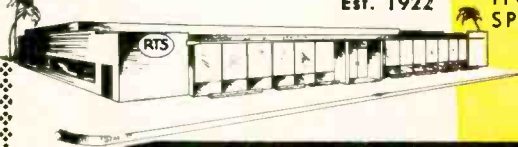

**ACT  
NOW!**

Get your free book on the  
**FAMOUS RTS BUSINESS PLAN**  
find out how you can open  
**A REPAIR SHOP OF YOUR OWN**

We supply and finance your equipment

When you are ready and qualified to operate one of our RTS-Approved TV Repair Shops **WE WILL SUPPLY AND FINANCE EVERY BIT OF EQUIPMENT YOU NEED TO GET STARTED** plus an inventory of parts and supplies. In other words we will stake you . . . **AN OFFER NEVER MADE BEFORE BY ANY TRAINING ORGANIZATION.** Under the RTS Business Plan you receive:

- |   |  |
|---|--|
| 1. An electric sign for the shop front.             | 6. Plans for shop arrangement.                               |
| 2. Complete laboratory of test equipment.           | 7. Instructions on how to go into business.                  |
| 3. Letterheads, calling cards, repair tickets, etc. | 8. Continuous consultation and help.                         |
| 4. Basic inventory of tubes, parts, supplies.       | 9. The right to use RTS Seal of Approval, and the RTS Credo. |
| 5. Complete advertising and promotional material.   | 10. The right to use the Famous Trade Mark.                  |

ACCREDITED MEMBER

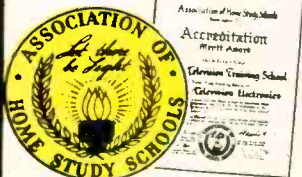

RTS' Membership in The Association of Home Study Schools is your assurance of Reliability, Integrity, and Quality of Training.

**ALL  
THESE  
FREE!**

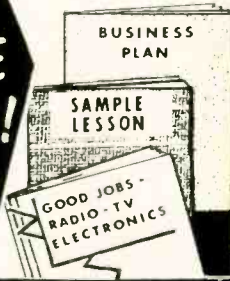

**CUT OUT AND MAIL — TODAY!**

**RADIO-TELEVISION TRAINING SCHOOL**

815 EAST ROSECRANS AVENUE Dept. RE-51  
LOS ANGELES 59, CALIFORNIA

SEND ME FREE — all of these big opportunity books — "Good Jobs in TV-Electronics," "A Repair Shop of Your Own" and "Sample Lesson." I am interested in:

- Radio-Television       Industrial Electronics (Automation)

Name \_\_\_\_\_ Age \_\_\_\_\_

Address \_\_\_\_\_

City & State \_\_\_\_\_

302

**Mail This Coupon Now—No Salesman Will Call**

**TODAY...**  
**a RACON exclusive**  
**TOMORROW...**  
**an Industry Standard**

NOW—For the First Time Racon offers you fast profitable installation of Sound System Speakers. You save time, money and temper with Racon's exclusive Built-in Terminal Block, besides being assured of the best investment in sound performance. No more running a soldering line to inaccessible areas, juggling splicing tape and pliers on the job and no more waste of time and money. A SIMPLE SCREW CONNECTION completes the entire installation. Completely waterproof and protected with a clear Plexiglas shield, the sturdy terminal block is not only convenient but guarantees a lifetime of trouble-free sound reproduction.

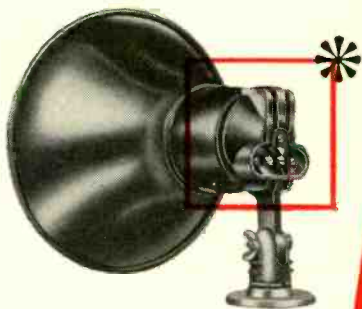

Model RL-10T . . . incorporates the world's only true multi-match built-in transformer, offering a wide selection of impedance and power taps for 70 v., constant impedance and the increasingly popular 25 v. lines. One simple connection in the shop prepares this speaker for installation. 10 w. continuous duty, high efficiency, smooth response.

Net Price — \$23.25

Write today for Racon's new descriptive catalog.

**RACON ELECTRIC CO., INC.**  
 1261 Broadway, New York 1, N. Y.

ACOUSTICAL EXCELLENCE SINCE 1922

In Canada: Active Radio-TV Ltd., 431 King Street, West, Toronto 2B, Ontario  
 Export: Joseph Plasencia, Inc., 401 Broadway, New York 13, New York

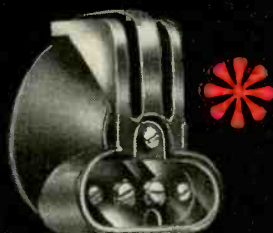

See how easy it is to connect the new Racon Model R0-25 Public Address Loudspeaker and . . . extended high and low frequency response for the best performance over any speaker of comparable size. 25 watt continuous duty.  
 Net Price—\$20.70



hooking up to a 300-ohm antenna circuit, for example, simply connecting a 50-ohm resistor across the output end of the 50-ohm coaxial line will not terminate the line correctly. Since the generator is supplying rf energy through

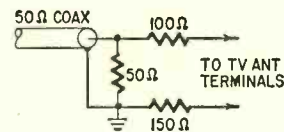

an unbalanced coax, and the average TV set input connection is for 300-ohm balanced, this method will create standing waves instead of preventing them. What is required is both an impedance conversion plus a conversion from unbalanced to balanced. A "balun" might be employed here, but a less expensive expedient which will do much the same thing is shown in the diagram.

Thank you for your excellent coverage of these important topics. Proper use of terminating resistors usually makes the difference between success and failure in TV alignment.

WILLIAM H. BUSHNELL

Fairfield, Calif.

**ABOUT THOSE PHONO PLUGS**

Dear Editor:

This letter is about the article, "Easy-To-Connect Audio Plugs", which appeared in the February issue on page 49. It gives credit to one company in particular for a phono plug with a built-in cable clamp. In addition, credits were also given to a certain company for a phono plug developed and manufactured in Great Britain.



For your reference, I have attached a copy of our catalog C-501 which illustrates our 3501MC phono plug with integral cable clamps. Switchcraft pioneered this development. Another of our plugs which should definitely have appeared in your article is Switchcraft type No. 3502. A photo of this phono plug is attached.

CLYDE J. SCHULTZ

Sales Promotion Manager  
 Switchcraft Inc.  
 Chicago, Ill.

END

**Advertising Representatives:** Los Angeles: Harker-Husted-Coughlin, 400 South Alvarado St. Tel. DUmkin 7-2328. San Francisco: Harker-Husted-Coughlin, 443 Market St., Tel. GARfield 1-0151. United Kingdom: Publishing & Distributing Co., Ltd., Mitre House, 177 Regent St., London, W. 1, England.

**Foreign Agents:** Great Britain: Atlas Publishing and Distributing Co., Ltd., 18 Bride Lane, London E.C. 4.

**Subscriptions:** Address correspondence to Radio-Electronics, Subscriber Service, 154 West 14th St., New York 11, N.Y. When requesting a change of address, please furnish an address label from a recent issue. Allow one month for change of address.

# LAFAYETTE is America's Citizens Band Headquarters

Complete Portable Communications for Everyone

**NO LICENSES,  
TESTS OR  
AGE LIMITS**



Ship  
to  
Shore



For  
Farming



Construction  
Work



HE-29

**COMPLETELY  
PORTABLE—  
POCKET SIZE**  
Only  
6 3/4 x 3 1/4 x 1 5/8"

## LAFAYETTE 9-TRANSISTOR CITIZENS BAND "WALKIE TALKIE"

**49.95**  
2.00 Down  
**2 for 96.50**

- Completely Wired—Ready to Operate
- Fully Transistorized — 9 Transistors plus 1 Diode
- Uses Inexpensive Penlight Batteries • No License, Tests or Age Limits • Comes with Leather Carrying Case, Earphone, Antenna, Batteries and Crystals

As simple and easy to use as the telephone—and twice as handy. Receives and transmits up to 7 miles under favorable conditions, or 1.5 miles under average conditions. Weighs only 18-oz. and slips into your pocket. Push-to-talk button operates built-in speaker as sensitive microphone.



Complete with Leather Carrying Case, Earphone, Antenna, Batteries, and Crystal

## LAFAYETTE HE-20A Deluxe CITIZENS BAND TRANSCEIVER

ONLY  
**109.50**  
5.00 Down



MADE IN U.S.A.

Now With Added Deluxe Features—

- Pi-Network for Greater Power Output • Calibrated "S" Meter
- 14 Tube Performance, 3 Diodes • Built-in 12 Volt Power Supply for Mobile Use • Complete with Matched Crystals for Channel 9

A highly efficient 2-way communications system operating over a distance of up to 20 miles or more depending on terrain. Features 4 crystal-controlled transmit positions and 4 crystal-controlled receive positions. Tuneable superhet receiver covers all 23 assigned channels. Other highlights include dependable push-to-talk ceramic mike & relay, adjustable squelch control, automatic series gate noise limiter and illuminated dial.

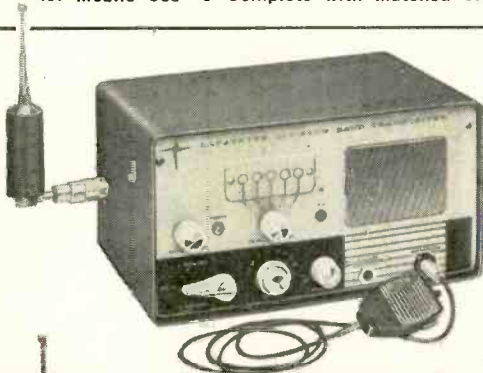

## LAFAYETTE HE-15A

ONLY  
**57.50**  
5.00 Down

MADE IN U.S.A.

## SUPERHET Citizens Band TRANSCEIVER

- Completely Wired—Not A Kit • 5 Crystal-Controlled Transmitting Positions
- Tuneable Receiver Over Full 23 Channels • High Output Crystal Microphone • Complete with Transmitting Crystal for Channel 9

A compact, precision transmitter and receiver covering up to a 20 mile or more radius, depending upon conditions. The HE-15A features an effective full-wave variable noise limiter, RF jack on front panel, planetary vernier tuning, 5-prong microphone jack for easy relay addition, and 12 tube performance from 4 dual-function tubes, 2 single-function tubes, 2 rectifiers.

- HE-19 Telescoping Whip Antenna ..... Net 3.95
- HE-16 Power Supply for 12 Volts ..... Net 10.95
- HE-18 Power Supply for 6 volts ..... Net 10.95

HE-800WX

## LAFAYETTE ALL-IN-ONE CITIZENS BAND MOBILE ANTENNA

The Scoop Buy for Citizens Band Mobiles

**6.95**

- Chrome Swivel Base • Stainless Steel Spring • 102 1/2" Stainless Steel Whip for Optimum 11-Meter Performance

Chrome swivel ball mount base designed for mounting on any surface. Stainless steel spring holds rod in properly adjusted position and prevents rod damage from shocks and blows. Stainless steel whip for maximum resiliency and strength.

## NEW! LAFAYETTE RADIO FIELD INDICATOR

- Continuously Indicates Transmitter Output
- Rugged 200 ua Meter Movement
- Requires No Electricity, Batteries or Transmitter Connection

Check the performance of marine, mobile or fixed transmitter. Features a 200 ua meter movement with variable sensitivity control. Earphones can be plugged in for an aural check of output. Antenna extends from 3 1/4" to 10 3/4". Magnet on bottom plate allows easy mounting on car dash or metal surfaces. Size, less antenna, 3 1/8W, 2 1/4H, 2"D.

A Must  
for All  
Ham  
and  
CB  
Operators

**6.95**



# LAFAYETTE RADIO

PLEASE INCLUDE SHIPPING CHARGES WITH ORDER

165-08 LIBERTY AVENUE, JAMAICA 33, N. Y. • OTHER LOCATIONS

NEW YORK, N. Y.  
100 6th Avenue

NEWARK, N. J.  
24 Central Avenue

BRONX, N. Y.  
542 E. Fordham Rd.

PARAMUS, N. J.  
182 Route 17

BOSTON, MASS.  
110 Federal Street

PLAINFIELD, N. J.  
139 W. 2nd Street

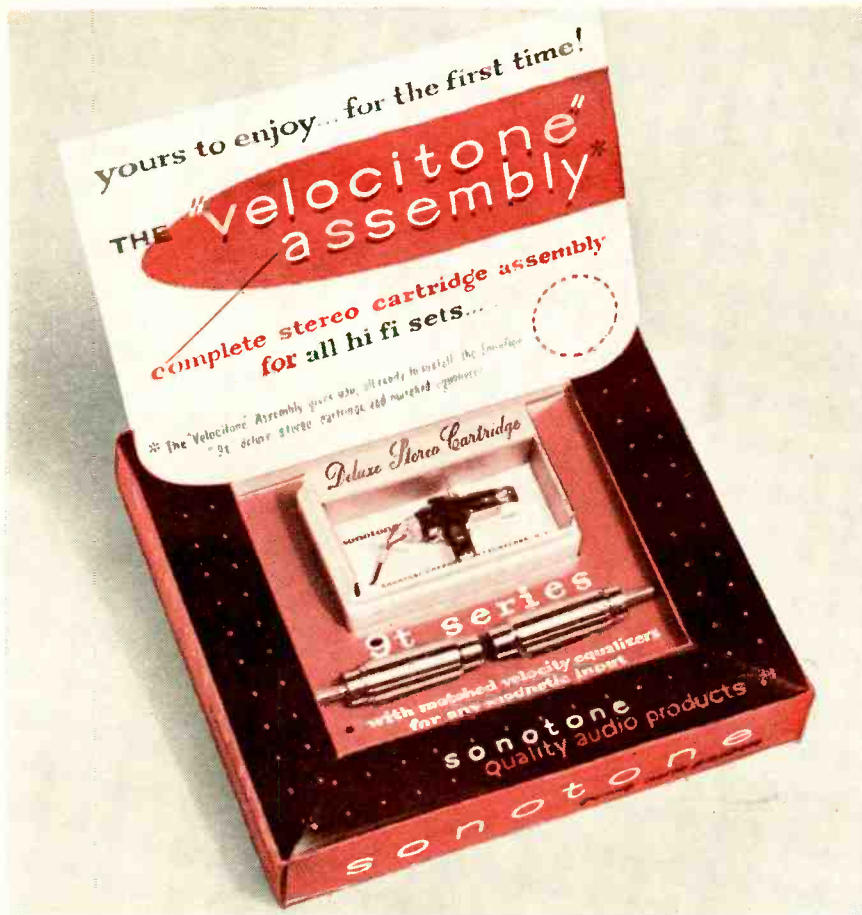

No stereo cartridge—not even the finest magnetic in the world—outperforms the

## Sonotone Ceramic "Velocitone"

**Listen!..** with your own magnetic... or with any magnetic you can buy today—at any price. Then replace it directly in your component system with Sonotone's new "VELOCITONE" STEREO CERAMIC CARTRIDGE ASSEMBLY. Listen again! We challenge you to tell the difference. Experts have tried... in dozens of A-B listening tests. And, in every single one, Sonotone's "VELOCITONE" performed as well as or better than the world's best magnetic.

**Listen!..** perfectly flat response in the extreme highs and lows (better than many of the largest-selling magnetics).

**Listen!..** excellent channel separation—sharp, crisp definition.

**Listen!..** highest compliance—considerably superior tracking ability.

**Listen!..** absolutely no magnetic hum—quick, easy, direct attachment to any magnetic inputs.

**Listen!..** remarkable performance characteristics unexcelled anywhere. (Write Sonotone Corporation for specifications.)

Now listen to the price. Only \$23.50... about one-half the price of a good stereo magnetic cartridge. Yet Sonotone's "VELOCITONE" stereo ceramic cartridge system cannot be outperformed by any magnetic—regardless of price.

# Sonotone<sup>®</sup>

CORP.

ELECTRONIC APPLICATIONS DIVISION, ELMSFORD, N. Y., DEPT. C2-51  
IN CANADA, CONTACT ATLAS RADIO CORP., LTD., TORONTO

LEADING MAKERS OF CARTRIDGES • SPEAKERS • TAPE HEADS • MIKES • ELECTRONIC TUBES • BATTERIES

# new LITERATURE

Any or all of these catalogs, bulletins, or periodicals are available to you on request direct to the manufacturers, whose addresses are listed at the end of each item. Use your letter-head—do not use postcards. To facilitate identification, mention the issue and page of RADIO-ELECTRONICS on which the item appears. UNLESS OTHERWISE STATED, ALL ITEMS ARE GRATIS. ALL LITERATURE OFFERS ARE VOID AFTER SIX MONTHS.

**TVI CAUSES, EFFECTS AND SOLUTIONS, General Review**, gives the problem detailed coverage by consolidating up-dated material from three previously published books and new information. Many illustrative photos and diagrams. —Harold R. Richman, Editor, Washington Television Interference Committee, Television Interference Aids, 1110 Lake Boulevard, Annandale, Va. Send 9 x 12 self-addressed, stamped envelope.

**ANTENNAS** and accessories are topic of *Communications and Citizens Band Products, Catalog FR-61-B*. Indexed booklet gives illustrated descriptive notes, purpose and price of each item. Chart of miscellaneous accessories concludes its 16 pages.—G C Electronics Co., Div. of Textron Electronics, Inc., 400 S. Wyman St., Rockford, Ill.

**METALLIZED PAPER CAPACITOR Catalog 131B8** features types capable of operation to 125°C without voltage de-rating. Gives complete physical and electrical characteristics and includes temperature characteristics curves and performance characteristics tables along with size charts and case style diagrams. —Aerovox Corp., New Bedford, Mass.

**RECTIFIER POWER TRANSFORMERS** P-8193 and P-8194 are presented in *Bulletin 587 11-60*. Single page contains specs and full- and half-wave bridge circuits for each.—Chicago Standard Transformer Corp., 3501 W. Addison St., Chicago 18, Ill.

**CAPACITOR** merchandising program folder. Two-color illustrated brochure mentions *Sportsmen's Delight* kit that includes free fishing lures; and the *Jewel Box* assortment, 45 Mylar-paper gold-dip capacitors encased in plastic cabinet.—Pyramid Electric Co., Distributor Div., Darlington, S. C.

**NEEDLE REPLACEMENT Wall Reference Chart for 1961** lists diamond, jewel or osmium needle by manufacturer's cartridge number and indicates record speed. Illustrates needle replacement.—Duotone, Locust St., Keyport, N. J.

**RADIO SERVICING, Advanced Tech-**

# a college-level home study program in electronics ...for serious-minded men desiring higher income and status



CREI's Extension Division offers you a college-level home study program in electronics comparable in technological content to advanced residence courses.

CREI has developed a program of home study that is comparable in technological content to advanced residence courses in electronics. The program was developed hand-in-hand with leading companies and Government agencies contributing to the Nation's efforts in electronics, communications, missiles, and space exploration.

This CREI program in Electronics Engineering Technology may be completed in 2 to 4 years, depending on how much of your spare time you can devote to study. The courses are presented in easy-to-understand form. Our instructors will give you personal attention and assist you when you need help.

To qualify CREI graduates for advancement to key technical positions, CREI offers a complete program in electronics, including—

Automation • Instrumentation • Industrial Electronics  
Aeronautical Electronics • Guided Missiles • Radar  
Servo-mechanisms • Computers • Astronautics • Tele-  
metering • Communications • Electronics Manufacturing  
Field Engineering • Nuclear Engineering Technology

There is a drastic need in the electronics industry for well-educated engineers and technical personnel. Although the great majority of students find ample opportunity for advancement with their present companies, CREI maintains a Placement Bureau to assist graduates and advanced students in finding more desirable positions. For many years, the demand for CREI graduates and advanced students has far exceeded the supply.

.....

Regularly across my desk, comes evidence that CREI's advanced Home Study Program in Electronics has provided an answer both for industry and for far-sighted men, who want to rise to higher levels of achievement. This evidence takes the form of letters from industry leaders and CREI graduates, who express their appreciation for the program and its value in their industry. These letters also state that advancements for CREI men are frequent and extensive. The CREI graduate may enjoy the benefits of new recognition, superior status and higher earnings as a result of his college-level electronics education.

*E. H. Rietzke, President  
Capitol Radio Engineering Institute*

A few of the private companies and government agencies whose officials approve CREI for their own personnel:

U. S. Navy (5,240 enrolled in extension program)  
Army, Air Force, Marine Corps, Coast Guard  
Columbia Broadcasting System  
National Broadcasting Company  
Federal Electric Corporation

Florida Power & Light  
Pan American Airways  
United Airlines  
The Martin Company  
All America Cable & Radio  
Voice of America  
... and many others

**QUALIFICATIONS FOR CREI.** You qualify if you have a high school diploma or equivalent, and if you have had basic electronic training and practical experience in electronics. Available to Veterans.

Write for our detailed 56-page catalog giving you complete facts, CREI also offers a Residence School program that qualifies graduates for an AAS degree. Day and evening classes.

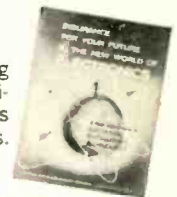

**Mail this coupon... today!**

## CAPITOL RADIO ENGINEERING INSTITUTE

ECPD Accredited Technical Institute Curricula • Founded 1927

Dept. 1405-H, 3224 Sixteenth St., N. W., Washington 10, D. C.  
England: CREI London, Granville House, 132-135 Sloane Street, London S.W. 1, England

Please send me your course outline and FREE 56-Page Book "Your Future in Electronics and Nuclear Engineering Technology" . . . describing opportunities and CREI home study courses in Advanced Engineering Technology.

- Check field of greatest interest
- Radar, Servo and Computer Engineering Technology
  - Electronic Engineering Technology
  - Communications Engineering Technology
  - Television Engineering Technology
  - Aeronautical Electronic Engineering Technology
  - Automation and Industrial Electronic Engineering Technology
  - Nuclear Engineering Technology

Name \_\_\_\_\_ Age \_\_\_\_\_

Street \_\_\_\_\_

City \_\_\_\_\_ Zone \_\_\_\_\_ State \_\_\_\_\_

Check:  Home Study  Residence School  Korean Veteran

To obtain fast, immediate service and to avoid delay, it is necessary that the following information be filled in:

Employed by \_\_\_\_\_

Type of present work \_\_\_\_\_

Education: Years high school \_\_\_\_\_ Other \_\_\_\_\_

Electronics experience \_\_\_\_\_



## NOW! An External Speaker System MADE ESPECIALLY FOR ELECTRONIC ORGANS

**Hear the full power and grandeur of your electronic organ  
with the Schober LSS-10 Loudspeaker System**

Organ consoles are made to house keyboards and components, not as acoustically designed speaker enclosures. With its close-up built-in speakers you can never experience the maximum of which your organ is capable. Adding a Schober LSS-10 fills the entire room with rich, lush organ music—makes you feel really powerful at the keyboards! With its full fundamental reproduction right down to 32 cycles per second, you will actually feel the lowest pedal note. With treble from the LSS-10 beamed to the ceiling for diffusion, your organ will have new clarity and life. The LSS-10 adds both tonal range and acoustical character that is natural and infinitely more pleasing than built-in organ speakers can ever be!

The LSS-10 can be added to any make or model electronic organ to sound alone or along with the original speakers. No amplifier is needed; the efficient LSS-10 connects to the amplifier in your organ and produces as much or more volume than the original speakers. For larger models or auditorium use, the LSS-10, used with a high-fidelity amplifier of 20 watts or more, is an equal-quality substitute for expensive "tone cabinets." It will handle 40 watts of organ tone. Driver units by Electro-Voice.

**LSS-10**—Complete speaker system, including assembled, sanded cabinet made of  $\frac{3}{4}$ " birch-veneer plywood, 24" wide, 19" deep, 36" high. Everything furnished (except length of lamp cord to connect speaker to organ), with detailed, illustrated instructions for mounting speakers and grill cloth (about an hour's work) and connecting to any organ. You need no knowledge or experience; no soldering necessary. Shipped by motor freight, transportation charges collect. Price, \$125.

**LSS-10W**—As above, but cabinet satin-finished in hand-rubbed Dark Walnut. Price, \$150.

**LSS-10S**—As above, but cabinet satin-finished in color of your choice. Specify color or send sample. Price, \$165.

**LSS-10K**—Same as above but less cabinet. Includes set of drawings for cabinet construction. Shipped by Railway Express collect. Price, \$69.50.

**TERMS:** Cash with order; no C.O.D.'s. New York City residents add 3% sales tax.

Not available through dealers. Sold direct only by

**THE Schober Organ CORPORATION**  
Dept. RE-13 43 West 61st Street, New York 23, N. Y.  
Manufacturers of the World-Famous Schober Organ Kits

niques, is 12-lesson correspondence course containing up-to-date information on maintenance and repair of automobile, AM/FM, transistor, marine and miscellaneous radios, including foreign-make and short-wave receivers. Write for details.—Sylvania Electric Products Inc., 730 Third Ave., New York 17, N. Y.

**ULTRAMINIATURE AUDIO AMPLIFIER** measures 0.531 inch in diameter and 0.228 inch high. TA-12-B featured in descriptive bulletin, 42-870, which details its electrical and physical specifications.—Centralab, Electronics Div. of Globe-Union Inc., 900 E. Keefe Ave., Milwaukee 1, Wis.

**RECTIFIER WALL CHARTS, 545-ECG** and *ECG 546*, will assist in selection of optimum silicon and germanium rectifier components for basic circuits on basis of average amperes per cell, recurrent peak reverse voltage and temperature. Color code. Explanatory notes.—General Electric Co., W. Genesee St., Auburn, N. Y.

**CAPACITANCE MEASUREMENT** is studied in *Aerovox Research Worker*, January-March 1960 and April-June 1960 issues. 8 pages, with figures, examine fundamentals of capacitance and discuss four methods for measuring it.—Aerovox Corp., New Bedford, Mass.

**AUDIO-STEREO** items introduced in 8-page *New Products Catalog FR-61-A*. Among additions to manufacturer's line are album of phono record accessories, volume and speaker controls and complete series of exact replacement record changer knobs.—Audiotex Mfg. Co. (Div. of Textron Electronics Inc.), 400 S. Wyman St., Rockford, Ill.

**CATHODE-RAY TUBES**, ranging from 5- to 24-inch screens are listed in *Bonded Shield*. 8-page booklet highlights design and performance advantages of latest industrial and military cathode-ray tubes in which safety panel is laminated to faceplate.—Sylvania Electric Products Inc., 1100 Main St., Buffalo 9, N. Y.

**HOME-STUDY COURSES** for individual and industrial training described in *General Catalog 1125N*. The more than 250 courses offered include 25 in electronics, ranging from short course on electronic fundamentals to electrical engineering with special electronics optional section. 11 of the 25 electronics courses are new.—International Correspondence Courses, Scranton 15, Pa.

**WIRELESS MICROPHONES**, FM receivers and radio-controlled relays are the subject of 4-page *Price Sheet 600926*. In addition the catalog contains specifications and a section describing suggested applications in multiple operation.—Vega Electronics Corp., 10781 N. Highway 9, Cupertino, Calif.

**CRYSTALS** and other precision-made equipment and their accessories are listed in a new 1961 catalog. Description and data, frequency ranges, modes of operations, technical information, some typical circuits and illustrations for almost every item fill its 31 pages.—International Crystal Mfg. Co., Inc., 18 N. Lee, Oklahoma City, Okla. END



# DOUBLES YOUR EFFECTIVE MANPOWER



Fix "Tough Dogs" Fast!

Save Half Your Time!

Step Up Your Profit!

**B&K** NEW  
MODEL 1076

## TELEVISION ANALYST

for Black & White and Color



Check all circuits—Pinpoint any TV trouble...in minutes

**By Easy Point-to-Point Signal Injection,  
You See the Trouble on the TV Screen and  
Correct it—Twice as Fast and Easy!**

There's no longer any need to "lose your shirt" (and customers)—and worry about the lost hours you never recover—on "tough dogs" or even intermittents. The remarkable B&K Analyst enables you to inject your own TV signal at any point and watch the resulting test pattern on the picture tube itself. Makes it quick and easy to isolate, pinpoint, and correct TV trouble in any stage throughout the video, audio, r.f., i.f., sync, and sweep sections of black & white and color television sets—including intermittents. Makes external scope or wave-form interpretation unnecessary. Most useful instrument in TV servicing! Its basic technique has been proved by thousands of successful servicemen the world over.

The Analyst enables any serviceman to cut servicing time in half, service more TV sets in less time, really satisfy more customers, and make more money.

Model 1076. Net, \$29995

Available on Budget Terms. As low as \$30.00 down.

Combines all the features of both  
the Model 1075 and Model A107

- |  |                                      |
|--|--------------------------------------|
| COMPLETE R.F. and I.F.                       | HI-VOLT INDICATOR                    |
| VIDEO TEST PATTERN                           | YOKE and HI-VOLTAGE TRANSFORMER TEST |
| COMPOSITE SYNC                               | <b>Also Now Provides:</b>            |
| FM MODULATED AUDIO                           | SWITCH-TYPE TUNER                    |
| COLOR PATTERNS                               | NEGATIVE BIAS SUPPLY                 |
| HORIZONTAL and VERTICAL PLATE and GRID DRIVE | AGC KEYING PULSE                     |
| B+ BOOST INDICATOR                           | PICTURE TUBE MODULATION              |



**B&K MANUFACTURING CO.**  
1801 W. BELLE PLAINE AVE • CHICAGO 13, ILL.  
Canada: Atlas Radio Corp., 50 Wingold, Toronto 19, Ont.  
Export: Empire Exporters, 277 Broadway, New York 7, U.S.A.

See Your B&K Distributor or Write for Bulletin AP16-E

# A PROPHECY

**F**or men and women with a sincere desire to succeed



“In the years that have passed since my days on the faculty of RCA Institutes, I have become even more firmly convinced that the individual who continues his education . . . particularly his technical education . . . is the individual who profits both as a thinking man and as a working man. Science and industry will reward you for your talents and energy. Out of your efforts may come inventions, new products, processes and services. There is everything good yet to be accomplished in our lives and in our work. What man has done, man can do better.”

*David Sarnoff*

Chairman of the Board,  
Radio Corporation of America

## *RCA Institutes Offers the Finest of Home Study and Resident Training for Your Career in the Rapidly Expanding World of Electronics*

RCA Institutes, founded in 1909, is one of the largest technical institutes in the United States devoted exclusively to electronics. A service of Radio Corporation of America, RCA Institutes offers unparalleled facilities for technical instruction . . . tailored to your needs. The very name “RCA”

means dependability, integrity, and scientific advance.

RCA Institutes Home Study School, licensed by the New York State Department of Education, offers a complete program of integrated courses for beginners and advanced students rang-

ing from electronic fundamentals to automation. All courses are designed to prepare you for a rewarding career in the rapidly expanding world of electronics. *The caliber of the training you receive is the finest!* And you get top recognition as an RCA Institutes graduate!

# HOME STUDY COURSES *in* *Electronic Fundamentals • TV Servicing* *Color TV • Electronics for* *Automation • Transistors*

**Voluntary Tuition Plan.** The important thing to remember about RCA Institutes Training is the convenient, *no-obligation payment plan*. This plan affords you the most economical possible method of home study training because you pay for each study group only when you order it. If you interrupt your course *at any time, for any reason*, you owe nothing more. You *never* have to pay for the whole course if you don't complete it. No other obligations. No monthly installment payments!



**RCA Instruction is Personal.** With RCA Home Study training you set *your own pace* in keeping with *your own ability*, finances, and time. The Institutes allows you ample time to complete the course. Your lesson assignments are individually graded by

technically trained personnel, and helpful comments are added where required. You get theory, experiment, and service practice beginning with the very first lesson. All lessons are profusely illustrated. You get a *complete training package* throughout the entire course.

**You Get Prime Quality Equipment.** All kits furnished with the course are complete in every respect, and the equipment is top grade. You keep all the equipment furnished to you for actual use on the job... *and you never have to take apart one piece to build another!*

\* \* \*

## RESIDENT SCHOOLS *in* *Los Angeles and* *New York City* train you for any field of *Electronics you may* choose!

**No Previous Technical Training Required For Admission.** RCA Institutes Resident Schools in Los Angeles and New York City offer training that will prepare you to work in re-

warding positions on research and production projects in fields such as automation, communications, technical writing, television, computers, and other industrial and advanced electronics applications. Even if you did not complete high school, RCA will prepare you for such training with courses specially designed to provide the basic math and physics required for a career in electronics.

**Free Placement Service.** RCA Institutes graduates are now employed in important jobs at military installations such as Cape Canaveral, with important companies such as IBM, Bell Telephone Labs, General Electric, RCA, and in radio and TV stations all over the country. Many other graduates have opened their own businesses. A recent New York Resident School class had 92.06% of the graduates who used the Free Placement Service accepted by important electronics companies... *and had their jobs waiting for them on the day they graduated!*



**Coeducational Day and Evening Courses.** Day and Evening Courses are available at Resident Schools in New York City and Los Angeles. You can prepare for your career in electronics while continuing your normal full-time or part-time employment. Regular classes start four times each year.



**SEND POSTCARD FOR FREE  
 ILLUSTRATED BOOK TODAY!  
 SPECIFY HOME STUDY OR  
 RESIDENT SCHOOL**

RCA INSTITUTES, INC. A SERVICE OF RADIO CORPORATION OF AMERICA, 350 W. 4th St., New York 14, N. Y., 610 S. Main St., Los Angeles 14, Calif.



The Most Trusted Name in Electronics

# EICO®...UNCOMPROMISING ENGINEERING

**BEST BUYS IN SERVICE INSTRUMENTS: everything from Scopes to Probes**



DC-5 MC  
5" Scope #460  
Kit \$79.95  
Wired \$129.50  
Also Avail.—5" Push-Pull Scope #425  
Kit \$44.95 Wired \$79.95



Peak-To-Peak  
VTVM #232  
& Uni-Probe®  
Kit \$29.95  
Wired \$49.95  
VTVM #221  
Kit \$25.95  
Wired \$39.95  
†Pat. #2,790,051



Dynamic Conductance  
Tube & Transistor Tester #666  
Kit \$69.95 Wired \$109.95  
Complete with steel cover & handle



TV-FM Sweep Generator  
& Marker #368  
Kit \$69.95 Wired \$119.95

**BEST BUYS FOR INDUSTRIAL TESTING: everything from Bridges to Supplies**



NEW Metered  
Variable AC  
Bench Supplies:  
#1073 (3 amp.)  
Kit \$35.95  
Wired \$47.95  
#1078 (7½ amp.)  
Kit \$42.95  
Wired \$54.95



NEW Extra-Low-  
Ripple 6 &  
12 Volt  
Battery  
Eliminator  
& Charger #1064  
Kit \$43.95  
Wired \$52.95



R-C Bridge  
& R-C-L Comparator #950B  
Kit \$19.95 Wired \$29.95



1350 Combinations!  
Series/Parallel R-C  
Combination Box #1140  
U.S. Pat. No. 2954518  
Kit \$13.95 Wired \$19.95

**BEST BUYS IN STEREO & MONO HI-FI: everything from Tape Decks to Speakers**



An original, exclusive EICO product  
designed and manufactured in the  
U.S.A. (Patents Pending)

Stereo/  
Mono  
4-Track  
Tape  
Deck  
Wired  
Model  
RP100W  
\$395.00  
Semi-Kit  
Model  
RP100K  
Electronics in Kit form \$289.95



NEW FM-AM Stereo Tuner ST96  
Kit \$89.95 Wired \$129.95 Inc. FET



NEW 70-Watt Integrated  
Stereo Amplifier ST70  
Kit \$94.95 Wired \$144.95



Bookshelf Speaker System HFS1  
Kit \$39.95 Wired \$47.95

**BEST BUYS IN "HAM" GEAR: from Transmitters to Code Oscillators**



NEW 60-Watt CW Transmitter #723  
Kit \$49.95 Wired \$79.95



90-Watt CW Transmitter #720  
U.S. Pat. No. D-184776  
Kit \$79.95 Wired \$119.95



Universal Modulator Driver #730  
Kit \$49.95 Wired \$79.95  
Cover E-5 \$4.50



Grid Dip Meter #710  
Kit \$29.95 Wired \$49.95

Over 2 MILLION EICO instruments in use. Compare EICO side-by-side critically with products selling for 2 or 3 times more. Buy your EICO right "off the shelf" from 1500 neighborhood dealers coast to coast, most of whom offer budget terms.

**BEST BUYS IN CITIZENS TRANSCEIVERS AND TRANSISTOR RADIOS**



Over 80 unique products to choose from!

EICO, 3300 N. Blvd., L.I.C. 1, N.Y. C-5

Send free 32-page catalog & Distributor's name.

Send Free Schematic of Model No. \_\_\_\_\_

Send new 36-page GUIDEBOOK TO HI-FI for which I enclose 25c for postage & handling.

Name \_\_\_\_\_

Address \_\_\_\_\_

City \_\_\_\_\_ Zone \_\_\_\_\_ State \_\_\_\_\_



NEW DeLuxe  
Citizens Band Transceivers:  
#770:117 VAC—  
Kit \$69.95 Wired \$99.95  
#771:117 VAC & 6 VDC,\*  
#772:117 VAC & 12 VDC\*—  
Kit \$79.95 Wired \$109.95



\*Including Posi-Lock®  
Mounting Bracket  
(PAT. PEND.)

Citizens Band Transceivers:  
#760:117 VAC—  
Kit \$59.95 Wired \$89.95  
#761:117 VAC & 6 VDC,\*  
#762:117 VAC & 12 VDC\*—  
Kit \$69.95 Wired \$99.95



Transistor Portable Radio RA6  
Kit \$29.95 Wired \$49.95 Incl. FET

Listen to the EICO Hour, WABC-FM, N. Y. 95.5 MC, Mon.-Fri., 7:15-8 P.M.

Add 5% in the West © 1961 by EICO, 3300 N. Blvd., L. I. C. 1, N. Y.

## INVENTIONS WANTED

... Our Armed Forces Call for New Electronics Ideas ...

In our May, 1960 issue, we printed a list of electronics ideas wanted by our Armed Forces. Here is the latest list, which contains mostly new requests.

Anyone may submit to the National Inventors Council proposals for basic inventions needed for national defense. Such proposals should be submitted separately, typewritten, if possible. It is advisable that descriptions be complete, including references to the basic principles underlying the invention and a discussion of any experimental work or tests that have been conducted. Advantages of the invention as compared to existing devices or techniques should also be listed. It is not necessary that sketches or drawings be professional.

Keep copies of all items presented and retain one copy that has been notarized with the exact date so you will always have proof of conception for patentability. This is important because your original copy will not be returned by the Government.

Note that the inventions listed here are outlined only sketchily. The Government booklet gives additional information about the *actual background and need* for each invention.

It is suggested that you write for the booklet *Inventions Wanted by the Armed Forces*, December, 1960, issue. Write to: National Inventors Council, US Department of Commerce, Washington 25, D.C. —H.G.

## ELECTRONIC COMPONENTS AND SYSTEMS

**1411. LOW-ENERGY, RELIABLE SWITCHING DEVICE.**—Develop a low-energy switching device (5,000 ergs maximum) capable of at least 100 reliable operations.

**1412. SEMIFLEXIBLE WAVEGUIDE.**—Develop a semiflexible waveguide in half-wave size for use in missile fuzing applications.

**1413. HIGH-FREQUENCY TRANSISTORS.**—Develop inexpensive high-frequency transistors (200 to 500 mc) that can handle 1 to 10 watts of power, and also develop transistors for frequencies between 50 and 100 kc that can handle 100 watts of power.

**1437. RELIABLE THERMISTORS.**—Produce a line of reliable thermistors that will provide a wide range of temperature coefficients and that will have highly repeatable characteristics.

**1438. MICROMINIATURIZATION.**—Vast amounts of work are being done in this field, especially in electronic components and subassemblies. Typical is the recently developed evaporative film technique.

**1439. LOW-VOLTAGE VACUUM TUBES.**—Develop a vacuum tube or other device that will operate on transistor low-voltage power supplies, and will ease the problem of using transistor circuitry to process high-impedance source voltages in control systems. This device shall be capable of eliminating unwanted feedback paths and shall have overall stability, small size, light weight and minimum power consumption.

**1441. FAILURE ANALYSIS OF ELECTRONIC COMPONENTS.**—Determine shock and vibration characteristics (test to failure) of electronic components, as mounted by conventional techniques utilizing a conventional chassis, to evolve the actual reasons for failure of components.

**1456. FLASH X-RAY DEVICE.**—Develop a 1-megavolt flash X-ray device with an extremely rugged or expendable power source of small size. The device should provide up to 10 flashes of 0.1- to 1- $\mu$ sec duration in an arbitrary but accurately timed sequence.

**1491. DISTINCTIVE AUDIO SIGNAL DEVICE.**—A device capable of producing a sound completely distinctive from present sirens, horns, whistles, bells, buzzers, engines (jet and reciprocating) or explosions. For a size and cost comparable to conventional sirens, the device should produce this sound at not less than 125 db (reference .0002 dyne per cm<sup>2</sup>) at 100 feet.

**1494. SOLID-STATE HIGH-IMPEDANCE AMPLIFIER.**—There is need for a solid-state amplifier with very high input-impedance characteristics (on the order of 10<sup>11</sup> ohms) and very-low-level noise characteristics, as a replacement for electrometer tubes in conventional ion-chamber detector radiation survey meters. Amplification of ion currents of the order of 10<sup>-11</sup> amperes is required for metering circuits requiring 50  $\mu$ a.

## LIGHT AND INFRARED

**1375. LIGHT SOURCE.**—A lightweight high-energy repetitive light source for night aerial photography.

**1415. INFRARED FUZE MODULATOR.**—Develop an electrical or magnetic modulator (shutter) for IR fuzes.

**1435. LIGHT-REFLECTIVE MATERIAL.**—Develop a material highly reflective to the light spectrum from infrared to ultraviolet, but transparent to radio-frequency radiation.

## RADAR, TRACKING, TV

**1374. V/H SENSOR.**—A lightweight small-size device for detecting the ratio of velocity with respect to height of a flying vehicle with an accuracy of 0.1 of 1% or better.

**1418. MISSILE-TARGET ATTITUDE SENSING SYSTEMS.**—Develop an inexpensive, lightweight testing device which gives, in addition to target miss distance, the relative attitudes of missile and target at intercept and fuze firing. The system is to be contained in drone targets and must be capable of transmitting the required information to the ground or recording it for future analysis after the target drone is eventually recovered.

## MISCELLANEOUS

**1378. PATTERN RECOGNITION.**—To develop techniques for electronically simulating human perception processes of judgment, observation and environment, in the recognition of patterns and symbols (Bionics).

**1444. ERASABLE, MAGNETIC TAPE.**—Develop an erasable, magnetic tape unit which provides an information storage density of at least 10<sup>12</sup> bits per cubic foot (random access not necessary).

**1449. CONVERSION OF HEAT ENERGY INTO ELECTRICAL ENERGY.**—Develop an efficient device for direct conversion of heat to electricity. The output should exceed 5,000 watt-hours per pound of device weight.

## AVIATION AND MISSILES

**1383. ACOUSTICAL TEMPERATURE SENSOR FOR ROCKET SOUNDINGS.** A need exists for a sensitive and rugged acoustical temperature sensor for application in meteorological rocket payloads. The temperatures to which the sensor would be exposed range from -60°C to +60°C. The device must withstand 50G acceleration and nose cone temperatures up to 150°C. The sensor would be expelled from the nose cone at apogee (250,000 feet) and would be lowered by parachute. The sensor would be required to operate with plus or minus 5% accuracy from 250,000 feet to 75,000 feet. The sensor and telemetry system should cost no more than \$250,000 per unit in lots of one hundred due to the cost restrictions on synoptic rocket soundings from several launch sites.

## COMPUTERS AND DATA SYSTEMS

**1379. LOW-SPEED FIELDATA PRINTER.**—To develop a low-speed fieldata page printer which is lightweight and small (pocket size), utilizing new principles for printing and other electromechanical functions. This unit must be very simple.

**1442. ANALOG-TO-DIGITAL CONVERTER.**—To process large volumes of data of all types, an analog-to-digital converter is required that is capable of converting all types of analog data (readings of voltage, current, pressure, intensity, velocity, acceleration, and so on) into digital format for magnetic tape storage without any intermediate manual steps such as reading amplitudes visually, tabulating values or plotting curves.

**1443. COMPUTER.** In the computer field there is a need to: (1) Develop a self-organizing computer which can perform functions analogous to human thinking; (2) Develop a technique which will obviate the propagation time restriction in fast computer designs; (3) Establish in basic computer philosophy the parameters for the optimum computer and formulate a method for determining the most efficient system configuration for a given application.

**1445. AUTOMATIC TRANSFER OF ORAL OR HANDWRITTEN INFORMATION INTO DIGITAL INFORMATION SIGNALS.**—Develop a mechanism to transfer automatically oral or handwritten information into digital information signals. These signals should be of such a configuration that they may conveniently be recorded on punched or magnetic tape or punched cards.

**1446. COMPUTER MEMORY DEVICE.**—Develop a random-access computer memory device with a .01- $\mu$ sec access time, a 10,000,000-bit capacity, and a volume of less than 1 cubic foot.

**1460. DIGITAL OUTPUT TRANSDUCERS.**—Develop transducers for use on rocket-engine test stands that have digital rather than analog output.

## TESTS AND MEASUREMENTS

**1320. (Revised) IMPACT ACCELERATION MEASURING AND RECORDING DEVICE.**—A device for measuring and recording high accelerations inherent with missile impact. The device should be self-contained in the missile and recoverable. It should be capable of recording the complete deceleration-time curve during impact.

**1380. NUCLEAR SURVEILLANCE DEVICE.**—Methods for obtaining three-dimensional location and yield of all nuclear detonations to ranges beyond line of sight, under all weather conditions. The method or methods proposed should combine  
(Continued on P. 110)

"Inventions Wanted" has appeared once a year in this space since 1957 in an effort to serve our Government as well as our readers.

We would appreciate a vote from you, on a postcard please, if we should continue "Inventions Wanted" in the future.

The Editors

*4-transistor set is a true cigarette-pack sized radio. Printed circuit speeds construction.*

# FLIP-TOP RADIO

By NICHOLAS A. TAX

**T**HIS four-transistor receiver uses a regenerative detector and three audio amplifiers to drive an earphone. It fits into a box from a pack of cigarettes. Sensitivity is high and no external antenna or ground is needed. A printed-circuit board is available to simplify construction. The transistors are reasonably priced and keep the total cost down.

The circuit is comparatively simple. The AO-1 works well as a regenerative detector. Other transistors were tried, but the AO-1 gave the best results. You may note that its collector load resistor (R2) seems high (100,000 ohms), but lower values reduce volume and selectivity.

## Chassis assembly

A printed-circuit board makes this unit easy to build. If you don't care to use one, you will need some stiff cardboard approximately 1/16 inch thick to make the chassis. From this cut two pieces  $\frac{7}{8}$  x  $3\text{-}1/32$ , then two pieces  $\frac{7}{8}$  x  $1\text{-}29/32$  inches. Cement these together to form a rectangle. Place the two short pieces on the inside so that the outer dimensions of the rectangle are  $3\text{-}1/32$  x  $2\text{-}1/32$  inches. This will form the chassis of the radio (around which we wind our antenna and tickler coils). Next cut a piece of cardboard  $1\text{-}29/32$  x  $1\frac{1}{8}$  inches (A in Fig. 2). Cement this piece inside the chassis 1/16 inch from the outer edge and at one end (Fig. 2). Then cut a piece of cardboard in the shape of a T (see drawing for dimensions) and cut the holes for the transistor sockets. Sockets are not needed with the printed circuit; the leads are simply soldered to the printed wiring (if desired, sockets can be used). Cement this piece inside the rectangle.

Place some Duco or similar cement in a small container and thin it down to a paintlike consistency with lacquer thinner or nail-polish remover. Then use a small paint brush to give the entire chassis two coats of this mixture (let the first coat dry about 30 minutes). This moistureproofs and stiffens the cardboard.

After the chassis is thoroughly dry, lock the sockets in the holes with the small clips furnished. Next cut the three holes needed for C2 on piece A. Mount C2, using two small screws supplied. Make a single hole on the other side of A in line with the capacitor-shaft hole. Mount the potentiometer with its lock washer and nut. There is enough space above the pot for the two electrolytic capacitors (C4 and C5). The capacitor and potentiometer shafts may have to be shortened so the knobs can be installed.

## Battery holders

Get a scrap of 1/16-inch Bakelite or other insulating material. Cut two pieces  $1\text{-}3/16$  inches long and  $13/16$  inch wide. You now need a scrap piece of 25-gauge stainless steel, copper or brass (shim stock will do). If you use the latter, tin it with solder to prevent corrosion. Make eight L-shape clips (see drawing for dimensions). Place four of them on a piece of lumber and give each one a sharp blow with an  $\frac{1}{8}$ -inch center punch to make a round dent in the metal (to hold the positive end of the battery firmly). Then, rivet the clips to the Bakelite. Small rivets were not readily available, so I used screen wire tacks.

Arrange four clips on each piece, spaced so the batteries will fit in firmly. The heads of the rivets were ground down somewhat so that the underside of the holder will be fairly smooth. Cut the rivets so that about 1/32 inch is left to flatten out. I used a very small ball peen hammer to do this. Stainless steel is relatively hard to drill, so use a center punch to make the hole, and smooth off the underside with a file. Then ream out the hole with a 1/16-inch drill bit.

Make sure that the width across the

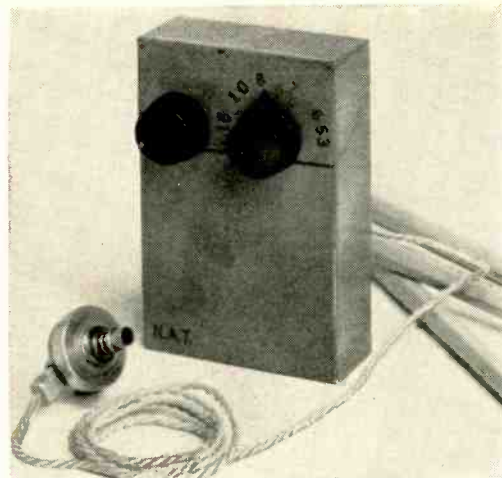

batteries in each holder is less than  $\frac{7}{8}$  inch (the width of the chassis) so that they will slide into the cigarette box easily. Use acid-core solder to tin a small spot on the outer side of each battery clip. Rosin-core solder will not stick to stainless steel. *Wipe or wash these spots off well because acid and radio parts just do not go together.* Now you can solder the wires to the clips with rosin-core solder. The next step is to cement the two battery holders to the inside of the chassis, one on each side. I cemented a piece of paper on each holder to indicate battery polarity for proper battery installation.

## Wind the antenna

The antenna and tickler coils are wound around the  $\frac{7}{8}$ -inch surface of the chassis with No. 30 enameled magnet wire. Make three small holes about 1/32 inch from the edge of the chassis by pushing a needle through the cardboard. Anchor the end of the wire through the holes, the free end extending inside the chassis. Leave about 3 inches to connect to the antenna terminal of the tuning capacitor. This will be the start of the winding.

Measure off 39 feet  $9\frac{1}{2}$  inches of wire beforehand and wind the 46-turn antenna coil, making sure that the windings are as close together as possible. Run the finish of the winding through the chassis (as before) and connect it to the ground terminal of the tuning capacitor. The tickler winding is 9 feet  $7\frac{1}{2}$  inches (11 turns). Wind it in the same direction and use the same size wire. Space the tickler coil  $\frac{1}{8}$  inch from the antenna winding, the start lead (TS in Fig. 1) going to the center terminal and the finish lead (TF) going to the left-hand terminal of the potentiometer (shaft facing you and terminals down).

Once again RADIO-ELECTRONICS is pleased to be able to offer its readers a printed-circuit board for an interesting construction project. The price is \$1.25 each, postpaid. They are available from Detroit Electronic Corp., 13000 Capital Avenue, Oak Park, Mich.

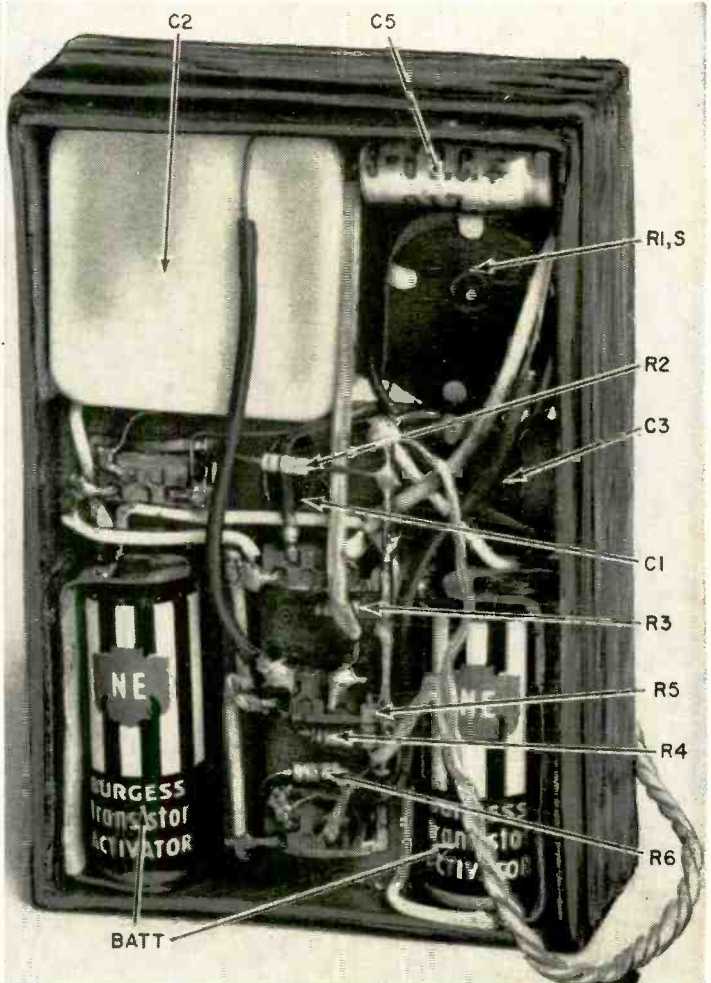
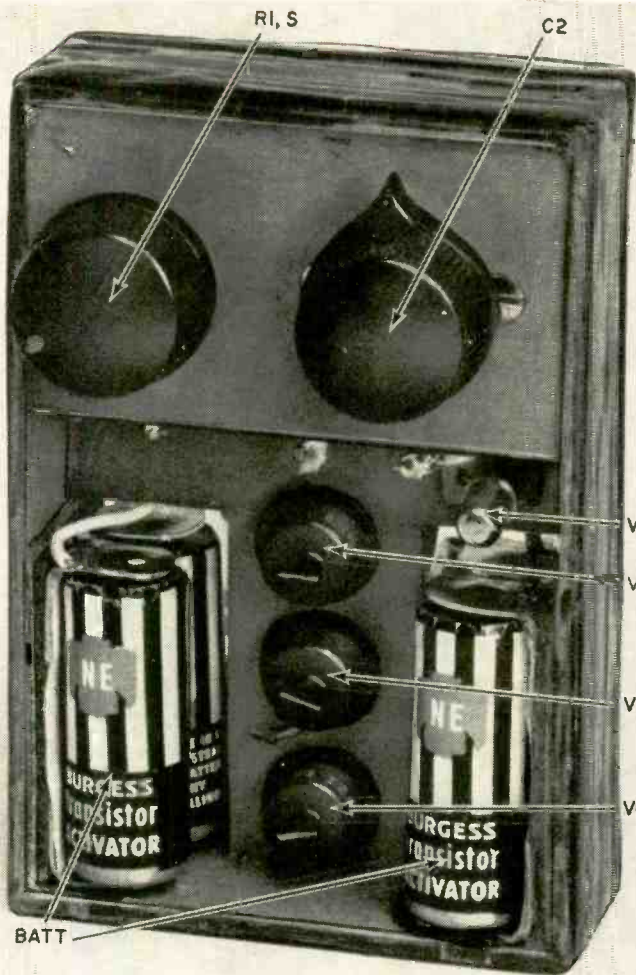

Inside the case, looking at the transistor side of the chassis.

Parts layout under the chassis.

- R1—pot, 10,000 ohms, with spst switch (Lafayette VC-28 or Philmore PC-53 or equivalent)
- R2, R6—100,000 ohms, 1/10 watt, 10%
- R3, R5—3,300 ohms, 1/10 watt, 10%
- R4—120,000 ohms, 1/10 watt, 10%
- C1, C3—.02 uf, 50 volts, ceramic
- C2—10—365  $\mu$ f, variable (Lafayette MS-274 or equivalent) (For printed-circuit unit: Calrad CR-220, Lafayette MS-445 or equivalent)
- C4, C5—3  $\mu$ f, 6 volts, miniature electrolytic
- BATT—6 volts, four 1.5-volt NE cells (For printed-circuit unit; 7-volts, Mallory TR-175 or equivalent)
- L1—see text
- L2—see text
- V1—AO-1 (Philco)
- V2, V3, V4—2N107
- Earphone, 1,500 ohms
- Transistor sockets (4)
- Wire, No. 30 enameled, 1/4-lb roll
- Miscellaneous hardware

When the coils are finished, give them a thin coat of hot paraffin to keep out moisture and secure them nicely.

It is important to have the correct amount of wire in the tickler winding. If the set does not oscillate (hissing or rushing noise) at the low end of the dial, add a few more turns of wire.

I noted a slight variation among some of the AO-1 transistors. One required about four turns more in the tickler winding so the set would oscillate at all points on the dial. If this happens to you, add these turns even if it is necessary to alter the spacing between the coils ( $\frac{1}{8}$  to  $\frac{3}{32}$  inch). If the set will not oscillate at all, you have probably reversed the leads to the potentiometer.

If your set motorboats when completed, add a stabilizing resistor from the positive end of the battery to V3's base. Start with about 2,700 ohms and work your way down.

Now wire the set, following the schematic (Fig. 1), or use the special RADIO-ELECTRONICS printed-circuit

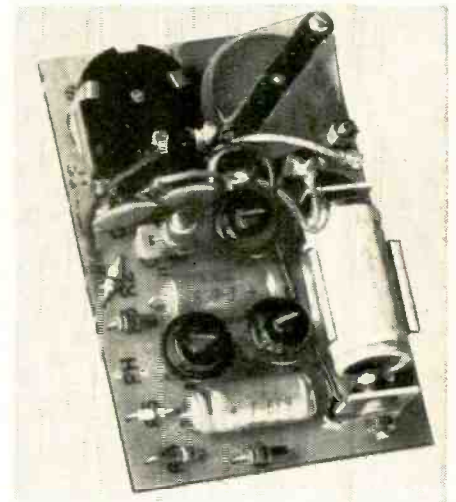

The printed-circuit board with all components mounted. Only the antenna still has to be connected.

**BENCH**



**TESTED**

The TAX radio was tested about 20 miles from New York City. Nine stations were received with ample earphone volume and good quality, and more could no doubt have been received with careful tuning. The loudest station, about 7 miles away, came in with sufficient volume to permit two persons to listen, with the earphone in a small dish on the table between them.

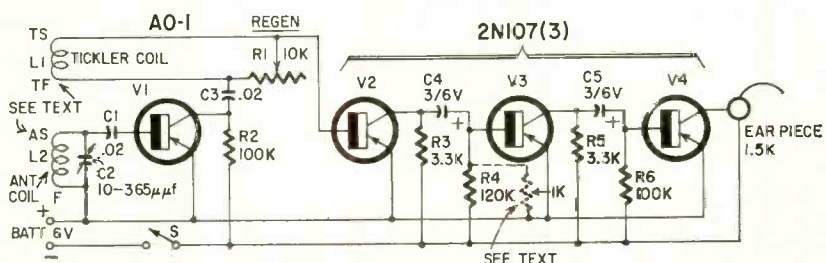

Fig. 1—Circuit of the 4-transistor receiver.

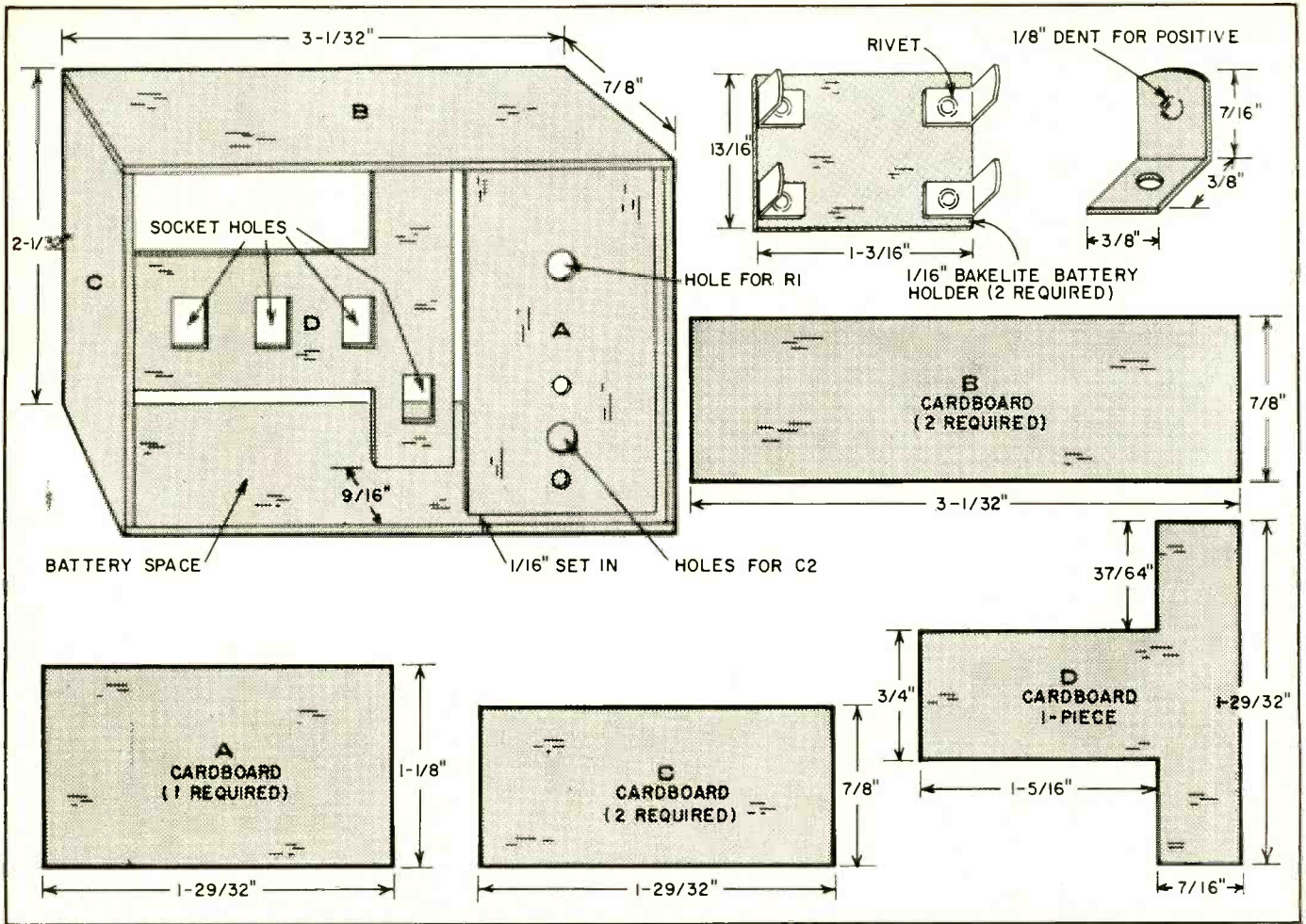

Fig. 2—Chassis assembly for the flip-top radio. If you use the printed-circuit board, only parts C and B are needed.

board. I used a piece of tinned copper wire as a negative bus. Solder it to one side of the switch and run it along the transistor sockets. I used 1/10-watt resistors; there would not have been space for 1/2-watt units.

**The case**

Select a cigarette flip-top box in good condition. Take a razor blade and carefully cut off the top where it hinges. Now make two slots in the top and two in the higher part of the box, so the chassis can be slid into the box and the top can be placed back on. Cut the slots wide enough to allow the tuning capacitor and potentiometer slots, and the case looks neat.

Now treat the cardboard box as you did the chassis (two coats of the thinned

mixture, inside and out). When thoroughly dry, give the case two coats of shafts to fit. The knobs will hide the your favorite-color enamel. Let the case dry for a few days before inserting the chassis. The box lips should be steel-wooled or sanded lightly to allow the top to slip on and off more easily (the freshly painted surface has a tendency to be a little tight). The chassis can be removed easily by grasping the two knobs and pulling upward.

To give the set a little added touch, calibrate the dial. The tuning-capacitor knob has a pointer on it. After some experience, you will know where the various stations in your locale come in and the dial can be calibrated. I have marked my set 16, 10, 8, 7, 6 and 53. These numbers can be put on by using

a toy printing or rubber-stamp set. Hold each number with tweezers and press it against a piece of glass that has a light coat of wet paint. Then press the piece of type to the case.

My set is very selective and will tune the entire broadcast band. Late at night, I have received stations 400 miles away and three stations some 1,500 miles distant. It is well established that regenerative receivers are distance getters. But, as with all regenerative sets, careful adjustments of both controls is absolutely essential. If the regeneration control is turned up too high, the set oscillates and reception is spoiled. On my set, the local stations can be heard with the earphone 6 feet away. Battery drain is low, so batteries last a long time. END

Fig. 3—The printed-circuit board; left—component side; right—wiring side.

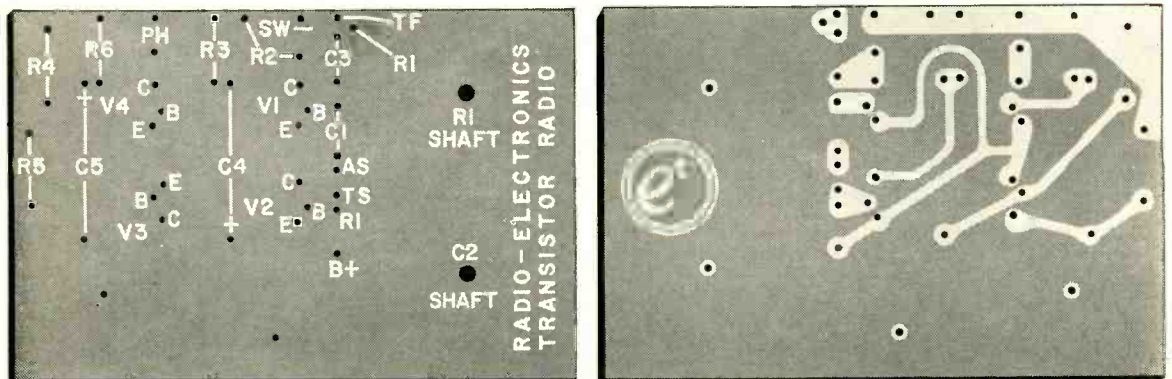



*A dual (stereo) 20-watt power amplifier with no compromise. The project was started with rigid specifications; and the completed amplifier*

# Quality Stereo amplifier



*meets them all. Frequency response is within  $\pm 1$  db from 10 to 40,000 cycles, or one octave above or below the audio range. You can build it yourself.*

WHY RESPONSE BEYOND THE AUDIO range? Because how an amplifier performs beyond the audio range definitely affects what is actually heard. For an amplifier to reproduce a 10,000-cycle square wave faithfully, it must be capable of handling frequencies uniformly beyond audible limits; hence the apparent extremes in frequency response. Incidentally, this indicates why examining the square-wave performance of an amplifier is an excellent way to measure its merit as a high-fidelity instrument. If I were able to make only one test, this is the one I would use.

Another yardstick is to measure intermodulation distortion. Simply, this measures undesirable products generated within the amplifier itself as a result of two or more signal frequencies beating against one another. The IM of this amplifier is less than 1% at its full power output. This means that even at relatively high listening levels

the distortion will be on the order of 0.25%.

Still another indication of amplifier performance is the measurement of harmonic distortion generated within that amplifier. Within 1 db of rated output of the unit, harmonic distortion at 20 cycles measured 0.6%, at 2,000 cycles 0.3%, and at 20,000 cycles 2%. Frequency response at full power is within 1 db from 15 to 30,000 cycles, and hum and noise are less than 1 mv measured across a 16-ohm load, or 90 db down from rated output.

The only limiting factor in the project was the actual power rating of the amplifier, which is 20 watts per channel. Although this appears to be on the scant side, the total power of the two channels (40 watts) is enough for good home reproduction since it represents more power than is now being used in many excellent monophonic systems. And, in this unit, the full 20 watts of

each channel is available from 20 to 20,000 cycles.

The extremely simple circuit (Fig. 2) uses the RCA 7199, designed expressly for this application. It is actually two tubes in one: a pentode and a triode in the same envelope—all that is needed for voltage amplification and phase inversion. The pentode, used as the voltage amplifier, provides all the gain necessary with ample margin for maximum usable negative feedback. The voltage amplifier is direct-coupled to the triode phase inverter to keep phase-shifting stages at a minimum. The R-C network at the plate of the pentode limits the upper bandpass of the earlier stages of the amplifier and avoids excessive phase shift at very high frequencies in the feedback loop. This eliminates stability problems likely to arise in this type of amplifier.

Negative feedback is taken from the secondary of the output transformer to

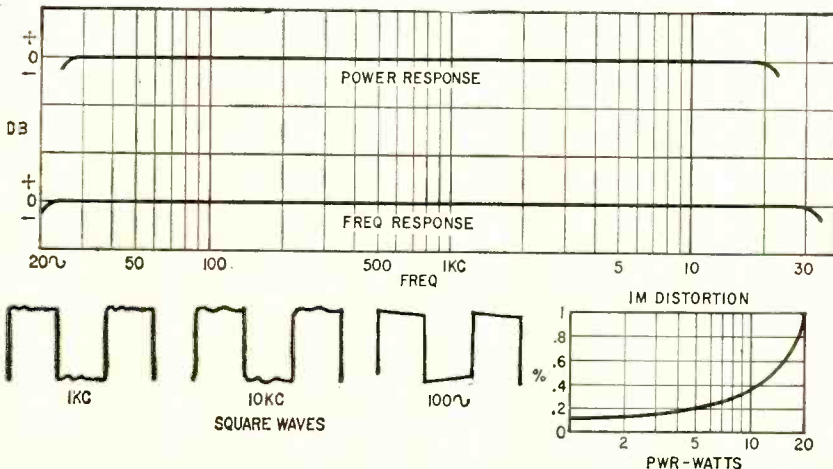

Fig. 1—Characteristics of the stereo amplifier.

the cathode of the input pentode. The triode cathodyne, or split-load inverter, is known for stability, balance and non-critical operation. Unlike several other popular inverters, its performance does not deteriorate with tube age. The circuit values have been chosen specifically for the available supply voltage and, because the circuit can handle much larger signals than required, it has the advantage of coasting along in the unmeasurable distortion range. Although the circuitry is not new, its use in audio has been popularized only in the last 2 or 3 years. Low initial cost, simplicity, stability and sensitivity are all virtues of this arrangement.

### Output stage

The 7189 output tubes are a fairly recent development. They produce a surprising power output for their size and power supply requirements. High power sensitivity, low inherent distortion and low cost are other desirable factors.

Choice of output transformers can make or break an amplifier design. Wide-band power-handling capabilities, excellent supersonic characteristics plus quality construction are among the reasons for making the Dynaco A-410 my choice.

Although the transformer has taps on its primary (for screen-loaded operation), they were not used in this amplifier. Tests showed no advantage in connecting the taps to the screen grids, but there is an actual power loss if the screen taps are used in this way. Apparently, this tube type works best as a pentode. One tap, however, did prove useful as a feedback point, which helped to establish the unit's excellent margin of stability. The screen grids were supplied with dc through a series dropping resistor to keep them within their dissipation rating.

Cathode bias is a matter of choice. Fixed bias would have resulted in a few more available output watts, but is more expensive and more difficult to set. Self-bias, on the other hand, is self-regulating, requires no adjustment or maintenance and is more faithful as tubes age.

The cathode resistor is bypassed for

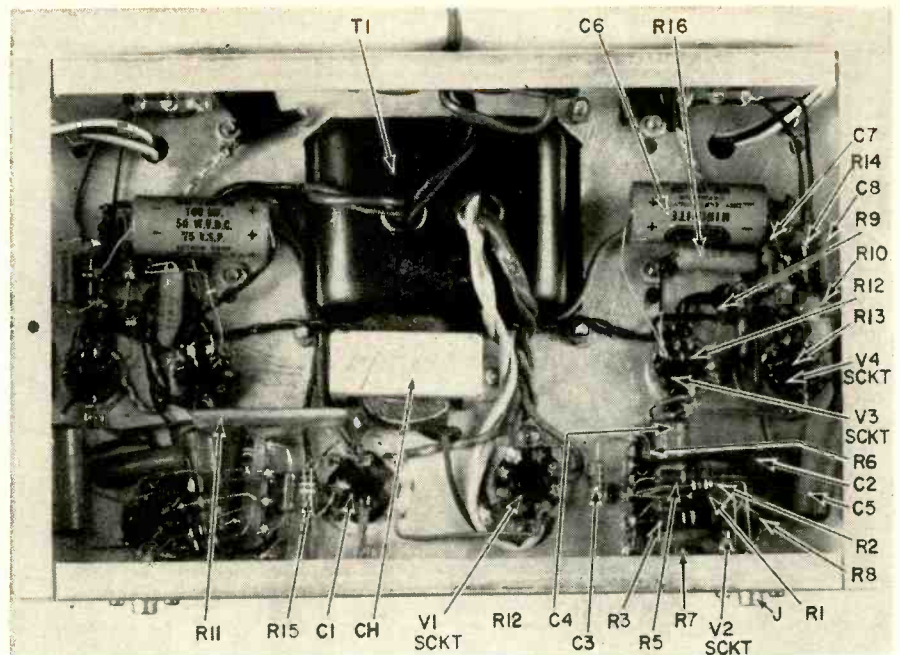

A look under the chassis. Only the components in one channel are pointed out.

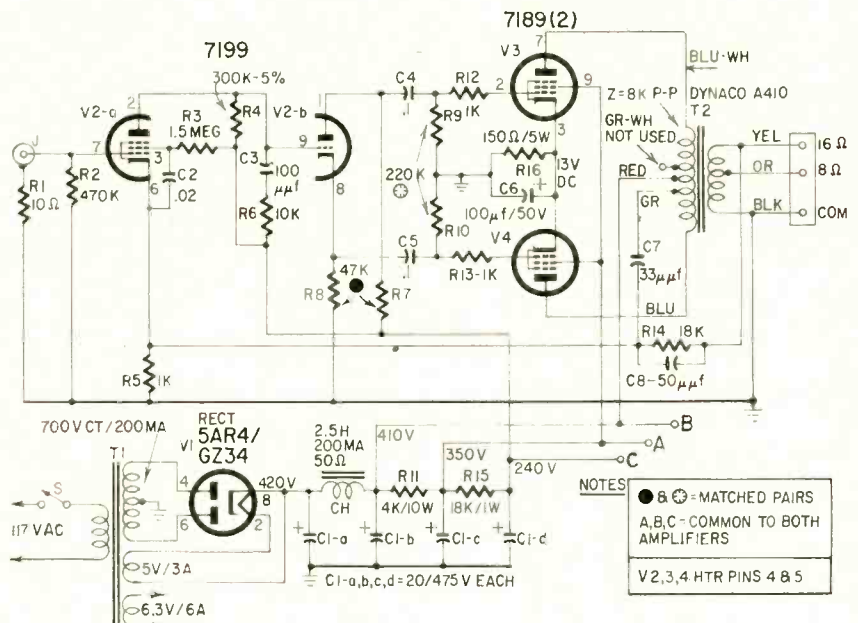

Fig. 2—Circuit of one channel of the stereo amplifier.

**BENCH**

Below are the measured specifications for the Laurent amplifier described in this article. Fig. 1 shows them graphically.

Frequency response: ±0.5 db from 25 to 25,000 cycles at 20 watts, 20 to 35,000 cycles at 1 watt.

Intermodulation distortion: (60 and 6,000 cycles mixed 4 to 1)

23 watts	.....	1%
20 watts	.....	0.57%
10 watts	.....	0.25%
5 watts	.....	0.1%

Noise: 0.9 mv across 16 ohms (86 db below 20 watts)

Gain: 0.94 volt input for 20 watts output

Square waves: slight rounding of leading edge first appears at 10,000 cycles. Total ringing about 5%. Slight phase shift starts to show below 100 cycles. Does not break into oscillation with any value of capacitive loading.

Power: 20 watts per channel.

**TESTED**

- R1—10 ohms
  - R2—470,000 ohms
  - R3—1.5 megohms
  - R4—300,000 ohms, 5%
  - R5, R12, R13—1,000 ohms
  - R6—10,000 ohms
  - R7, R8—47,000 ohms (matched within 1%)
  - R9, R10—220,000 ohms (matched within 1%)
  - \*R11—4,000 ohms, 10 watts
  - R14—18,000 ohms
  - \*R15—18,000 ohms, 1 watt
  - R16—150 ohms, 5 watts
- All resistors 1/2-watt 10% unless noted
- \*C1—20—20—20—20 μf, 475 volts, can type electrolytic (Sprague TVL-4834, C-D D0179.5, Mallory FP475)
- C2—.02 μf, molded
  - C3—100 μmf, tubular ceramic
  - C4, C5—.01 μf, molded
  - C6—100 μf, 50 volts, electrolytic

- C7—33 μmf, tubular ceramic
  - C8—50 μmf, tubular ceramic
  - \*CH—2.5 henries, 200 ma, 50 ohms (Merit C2974 or equivalent)
  - J—phono jack
  - \*S—spsst toggle
  - \*T1—power transformer: primary, 117 volts; secondary, 700 volts, ct, 200 ma.; 5 volts, 3 amps; 6.3 volts, 6 amps (Thorndarson 22R07 or equivalent)
  - T2—output transformer, Dynaco A410
  - \*V1—5AR4
  - V2—7199
  - V3, V4—7189
- Chassis to suit
- Miscellaneous hardware
- \*Only one of each of these components is necessary
- For a stereo amplifier, two of all other components are needed to build the amplifiers for the two channels.

all frequencies. Observe that here a single resistor could be used for all four output tubes. However, a separate one for each channel insures independent operation of the stereo channels without transient disturbances being reflected from one side to the other.

#### Power supply

The power supply for a stereo amplifier requires special attention too. An improperly designed supply that allows excessive cross-talk and interaction between the channels defeats stereo performance. In this unit the rectifier is selected for low impedance and husky current rating so a heavy current demand by one channel will not cause a drop in supply voltage and be reflected into the other channel. A choke is used where a resistor might have served, for the same reason. Considerable filter capacitance is used to avoid interchannel coupling.

The charts in Fig. 1 give a picture of the amplifier's performance. Frequency response, square waves and intermodulation distortion are all yardsticks by which an amplifier can be measured; and a critical listening test tells the final tale. You will find this unit meets all the requirements demanded by a "golden" ear.

#### Now build it

Construction offers no problems. There are no overly critical points in the wiring process. Simple point-to-point wiring should be followed, keeping high-impedance portions of the circuit away from ac fields. A larger chassis may be used for ease of construction. Heater wires should be twisted pairs. When heater leads must cross or come near other components, they should do so at right angles where possible. The power transformer is mounted for minimum effect on the output transformers. Notice that the input jacks are insulated from the chassis. Although not essential for the operation of the amplifier, the isolation of the signal grounds with 10-ohm resistors reduces the possibility of ground loops in your stereo system. It is common practice to use an unused pin on the output sockets to mount the 1,000-ohm grid stopper resistors. *This must not be done with 7189 output tubes as there are internal connections to the apparently unused pins.*

If you are not ready for a stereo system, this unit will make an excellent 40-watt monophonic amplifier. Simply parallel the inputs and outputs of amplifiers. The only limitation is that paralleling the 16-ohm taps limits the unit to a maximum of 8 ohms output impedance.

The sensitivity of the unit—0.94 volt input for 20 watts output—makes it compatible with just about any preamp. The amplifier generates some heat, as do all power amplifiers, and therefore should have ample ventilation. Good components and careful construction will provide you with an amplifier capable of long service and which is a "sound" foundation for your stereo system. END



*Part II—Another transistor tuner. This one by Standard Coil.*

# Transistor Tuners for TV

## *What makes them tick?*

By E. D. LUCAS, JR.

Fig. 1 shows the circuit of the new Standard tuner being produced for Motorola and other TV receivers. Signal from the antenna comes through a 75-ohm unbalanced input, passes through two if traps (outlined by dashed lines) and then through an FM trap (C2, L7 tunable). This input circuit keeps cross-modulation to a minimum. Also, a good match is provided between the antenna impedance and the input impedance of the rf amplifier. In this tuner, the VSWR is maintained at less than 2 to 1 on all channels.

Note that the common-emitter rf stage is operated with forward age applied from the 13-volt source through a potentiometer. The 1,200-ohm series collector resistor, R4, drops the collector voltage as the collector current is increased. An increase in base or forward bias causes an increase in the collector current. Now, as previously noted, the collector voltage decreases, and there is a decrease in the gain of the rf amplifier. An advantage of forward age action as compared to negative age, the technique of reducing collector current by reducing base bias, is that the forward or positive age method results in a smaller change of input impedance with applied age voltage. As a result, the impedance match between antenna and transistor input is better and the VSWR is improved over the entire vhf range. Also, the input signal is less subject to cross-modulation at reduced gain levels.

In the Standard tuner shown in Fig. 1, two capacitors, C5 and C6 (a feedthrough type), provide out-of-phase feedback to neutralize the rf amplifier. Fixed values of neutralization capacitances can be used because the variable transistor capacitances are swamped out by the relatively high circuit capacitances.

Conventional coupling between L2 and L3 feeds the rf output to the mixer

coil, and trimmer C11 is adjusted to tune the input circuit of the mixer. Notice that this stage has a common-base design as contrasted with the common-emitter mixer of the Sickles Mark 6T we saw last month.

The common-base configuration is also used in the oscillator circuit, which includes a small capacitor, C19, between collector and emitter to assure stable oscillation. Special care has been taken by the design engineers not to load the oscillator output to such an extent that oscillation is not sustained. To maintain oscillation, the collector output is connected to the mixer by the small capacitor, C18. Oscillator frequency is obtained in a manner similar to tube type tuners, with the tunable individual oscillator coil for each channel, L4, paralleled by another variable coil, L10, for fine tuning. L10 has somewhat greater inductance than L4, which may be slug-adjusted from the front.

This oscillator is designed to provide an injection voltage of 150 to 500 mv across the 60- $\mu$ f matching capacitor, C13, in the emitter (input) circuit of the mixer. Injection voltages in the range cited appear to provide maximum conversion gain.

The common-base mixer converts the rf signal from the rf amplifier to a 45-mc if. This mixer is designed to drive, from its collector output, the if load impedance consisting of a 50-ohm resistor in parallel with an adjustable pi network. Regeneration, gain and loading are controlled by the output tank circuit, including variable inductor L9 and feedthrough capacitor C17 (8.2  $\mu$ f). Since the value of C17 will partially determine the oscillation threshold of the mixer, it is considered critical. This capacitor also swamps out variations in the mixer's output capacitance.

In one of their earlier transistor tuner designs, Standard engineers experimented with common-base rf am-

plifier designs. This approach proved to have certain disadvantages compared to the common-emitter configuration now used. Common-base input resistance increased from about 25 ohms for channel 2 to 135 ohms at channel 13—an impedance change of more than 5 to 1. Meanwhile, the output resistance of the MADT transistor sloped off from 8,000 ohms at channel 2 to 4,000 ohms at channel 13. In addition, the reactive portions of the input and output impedances were naturally also dependent on frequency. Both the resistive and reactive components of these impedances were functions of the operating point or bias of the transistor. As a result, the impedance changes required considerable compensation in the design of both the input network to the rf amplifier and the interstage network between it and the mixer.

While the common-emitter rf amplifier presents a problem in changing input impedance with frequency, it is less severe since the change is from only 135 ohms at channel 2 to 60 ohms at channel 13 in a typical design—in contrast to the 5-to-1 variance of the common-base amplifier. Another advantage is that this input impedance falls off with frequency, as does the output impedance of the grounded-emitter connection. Here again there is a relatively small change in impedance, with the output resistance of the grounded-emitter amplifier changing from approximately 3,000 ohms at channel 2 to 1,200 ohms at channel 13.

A further reason for using the common emitter is that the common-base circuit tends to become regenerative because the emitter and collector voltages are nearly in phase. Inserting a small external capacitance between collector and emitter may cause the rf amplifier to become an oscillator—the technique used in the common-base local oscillator of Fig. 1. This regeneration can be partially controlled by selecting a suitable collector load but internal capacitance, emitter to collector, may be high enough in some transistors to cause undesired oscillation. By contrast, in the common-emitter rf amplifier the input signal is relatively out of phase with the output signal and we get internal negative feedback. As a result, this type of amplifier has inherent degeneration, so most circuit designers using the common-emitter configuration use neutralization to inhibit degeneration.

Typical performance characteristics of the current Standard transistor tuner are presented in Fig. 2. Gain figures are very good indeed, ranging from 41 db at channel 2 to 23 db at channel 13, while the noise figures are consistently good, from 6 to 8.5 db. In this tuner, a 13-volt negative supply was used and the maximum gain appeared at an agc voltage of  $-0.8$ . The fine-tuning range is 5-6 mc and such characteristics as if and image rejection, VSWR and maximum gain reduction (using forward agc) are entirely satisfactory.

This transistor tuner can be used for

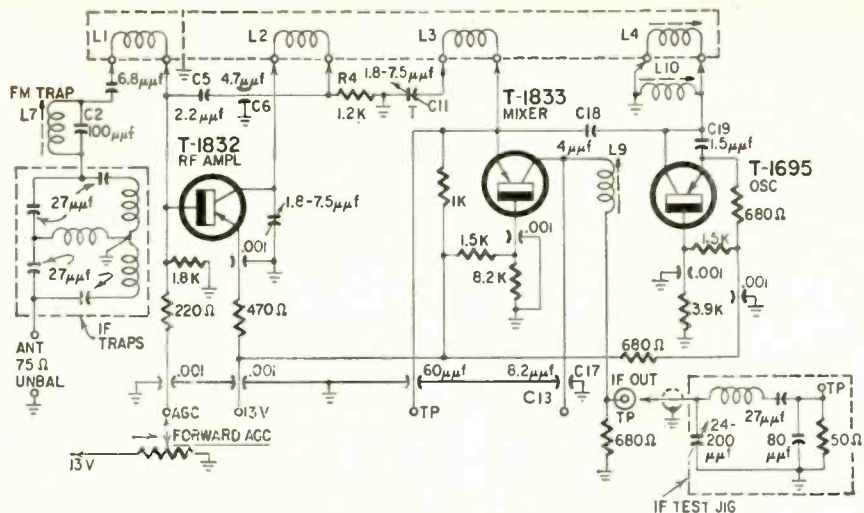
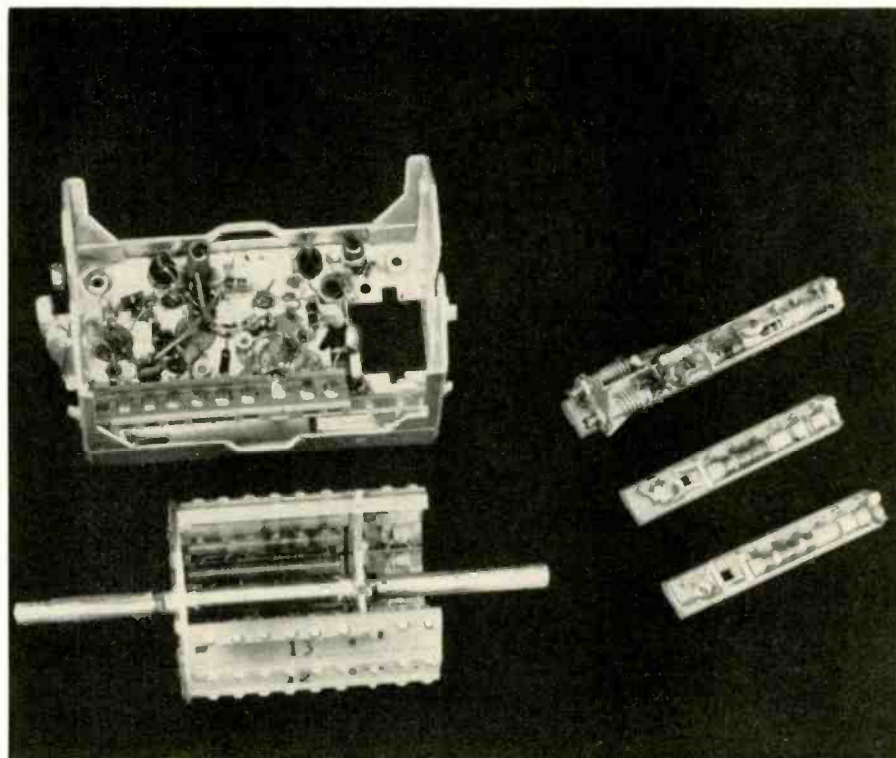

Fig. 1—Circuit of the Standard transistor tuner used by Motorola.

The Standard Coil transistor tuner.



Standard tuner with insides exposed.



# a loud picture

By H. R. HOLTZ

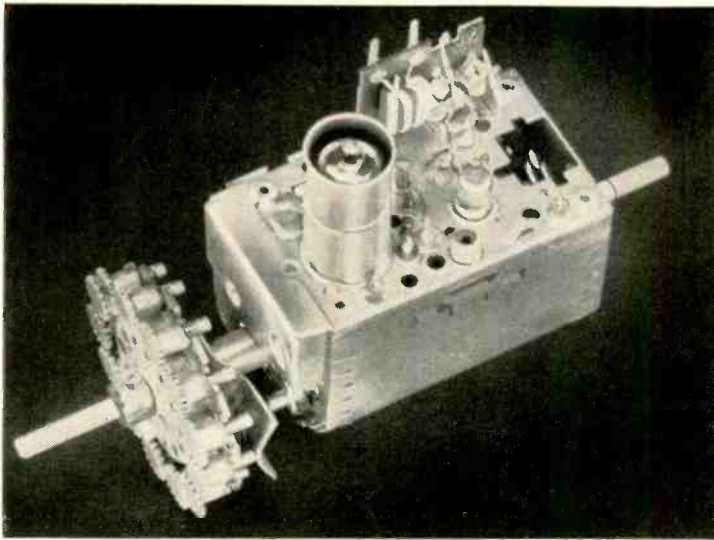

Nuvistor tuner uses one nuvistor and one standard vacuum tube.

uhf reception as well as vhf by adding typical uhf strips similar to those used with Standard's familiar cascode and neutrode tube type tuners. Noise figures with the transistor tuner approach those obtainable with vacuum tubes—for example, 14 db measured with a channel 29 uhf strip inserted. Bias voltage for the mixer diode in the uhf strip is supplied by the vhf tuner, and the uhf mixer is forward-biased to assure a respectable noise figure. In uhf operation, the conversion to 45-mc if occurs in the uhf strip, as is the usual practice with tube type tuners. The rf amplifier and mixer are both used as if amplifiers.

Physical dimensions of this new Standard transistor tuner are almost identical with those of the present miniature Guided-Grid tuner and the new miniature nuvistor tube type tuner developed for RCA by Standard-Kollsman, except that there is a saving in height in the transistor unit since tubes and tube shields are eliminated.

## Nuvistor tuner

This new vacuum-tube tuner using nuvistors is now in production by Standard. Essential features of this kind of tuner were described (RADIO-ELECTRONICS, page 48, January, 1961). A neutralized triode or neutrode rf amplifier is used. Gain figures for the tuner range from 42 db at channel 2, to 40 db at channel 13. Noise figures are 3.5 db and 5.0 db, respectively, for the same channels. Performance with the nuvistor tubes is considered excellent by Standard engineers. END

## References

- C. R. Gray, Application Lab Report 606, "14-Inch Direct-View Transistorized Television Receiver," Lansdale Div., Philco Corp.
- J. Specialny, Application Lab Report 581, "VHF Tuner," Lansdale Div., Philco Corp.
- Edgar Messing, "Transistorized Tuner Notes," F. W. Sickles Div., General Instrument Corp.
- Karl Wittig, "Transistorized TV and FM Tuners," Standard-Kollsman, Inc., Los Angeles; Semiconductor Products, July 1960.
- E. D. Lucas, Jr., "TV Tuner with a Guided Grid," Radio-Electronics, January, 1960.

Fig. 2—Specifications for the Standard tuner.

CHAN	POWER GAIN (DB)	NOISE FACTOR (DB)	IF REJ. BALANCED (DB)	VSWR (WORST)	BAL. TO UNBAL. (DB)	MAXIMUM GAIN REDUCTION (DB)	IMAGE REJ. (DB)	FINE TUNING RANGE (MC)	
2	41	6	>60	<2/1	35	52	>70	6.0	
3	40	6		↑					
4	39	6							
5	37	6							
6	36	6	>60			31	45	>70	5.4
7	27	8	>70			30	36	>60	5.0
8	27	8							
9	26	8							
10	25	8	>60			25	35	>60	5.0
11	25	8.5							
12	24	8.5							
13	23	8.5	>60		<2/1	23	35	52	5.0

It was strictly a routine call. No picture, sound bad. The first complaint was caused by a complete lack of high voltage. The second was justified by a definite hoarseness or muffled quality. Since I was going to pull the set anyway, to have an underchassis look at the horizontal circuits, I didn't bother much with the audio trouble, leaving it for the final stages of the bench work.

On the bench, I turned the set on and dawdled a moment before digging in (since it was a vertical-chassis Admiral of about 1957 vintage and I am just as lazy as the next guy about pulling the picture tube to get at the tube-socket wiring).

Quite inadvertently, I kicked the volume up to maximum. Lo and behold, a picture! I backed the volume off. No picture.

The partial schematic shows a typical arrangement of such a circuit. The cathode and grid of the audio output tube are at about 145 volts dc (the grid is actually a few volts lower to provide suitable bias). The cathode supplies the if plates and screens and the screen grid of the horizontal output tube.

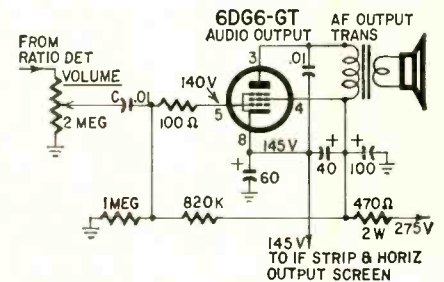

Note capacitor C. At the low end of the volume control, the control grid is at ac ground through this capacitor. Now suppose this capacitor is shorted (as it was in this set). Now the grid is grounded, and 145 volts negative to the cathode. The tube cuts off, cathode voltage drops and the if strip and horizontal output stages are out. Only at high volume settings, with the volume control between it and ground, is the grid, and therefore the cathode, at high enough potential to supply the horizontal output screen. END

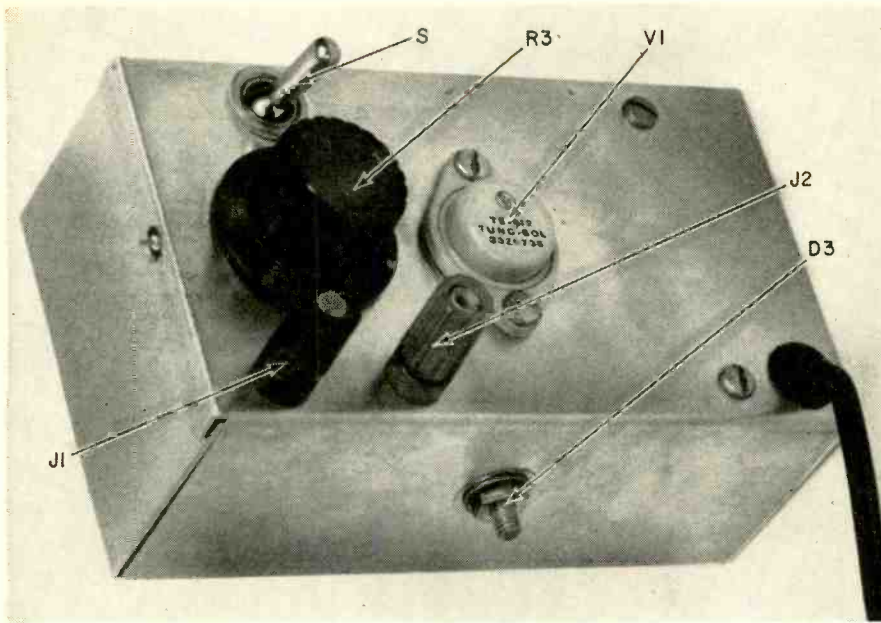

Simple supply makes a neat-looking package.

# ELECTRONIC DRY CELL

Constant-impedance variable-output power supply for semiconductor projects

By  
DONALD L. STONER

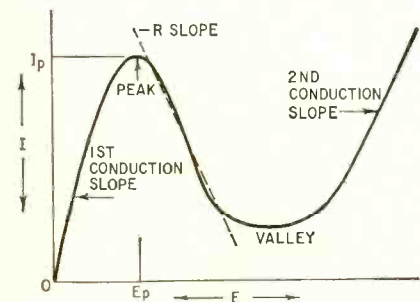

Fig. 1—Typical Zener-diode characteristic curve.

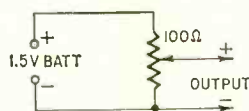

Fig. 2—Battery with series voltage control does not have constant impedance.

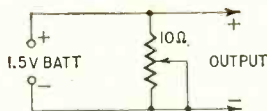

Fig. 3—Battery with parallel voltage control has short life.

ANYONE who experiments with semiconductor devices soon learns that an adjustable power supply is necessary. He also discovers that the supply should be *well regulated* and have an *extremely low output impedance*.

This is particularly true of tunnel diodes. These devices operate on the negative-resistance slope of their characteristic curve (Fig. 1). As the supply voltage increases, the diode reaches a peak current. This point is called  $E_p$  and the current flow is, of course,  $I_p$ . From this point on, as the voltage across the diode terminals increases, current drops until it reaches a low or valley. From the curve you can see that the junction current drops even though the supply voltage increases. This indicates that the diode has *negative-resistance* characteristics.

Negative resistance, whether in a diode or any other device, makes special demands of the power supply. In the Esaki diode, for instance, when the current drops, supply voltage will increase slightly if power supply regulation is poor. The increase in voltage is enough to carry the current down the negative-resistance slope, past the valley and up the second conduction slope. The same conditions exist when reducing the voltage. Thus, the diode will switch rapidly from peak to valley or the other way around. It will never rest between these two points as this can happen only if the impedance of the

power supply is less than the negative resistance of the diode. This effect is used in computers for millimicrosecond switching of information bits.

## Battery power

Batteries provide a simple, reliable method of supplying power to semiconductor devices. Although the fresh dry-cell battery has a relatively low internal impedance, it obviously is not adjustable. Many new semiconductor devices (tunnel diodes, controlled rectifiers, etc.) require voltages less than the 1.57 volts supplied by a fresh cell. Any attempt to reduce the voltage of a 1.5-volt cell will either raise the source impedance or cause excessive battery drain!

As an example, Fig. 2 shows a 100-ohm potentiometer connected as a voltage divider across a 1.5-volt battery. For an output of, say, 0.75 volt, the potentiometer would be set in the center of its resistance range. Thus the source impedance would be approximately 25 ohms since the two halves of the potentiometer are essentially in parallel. If we arbitrarily say that the battery has an internal resistance of 1 ohm, then you can see the potentiometer has destroyed the impedance and regulation by a factor of approximately 25.

Another method of lowering battery voltage is shown in Fig. 3. Here a potentiometer is connected in parallel with the battery to provide a variable load. As the resistance is decreased, the

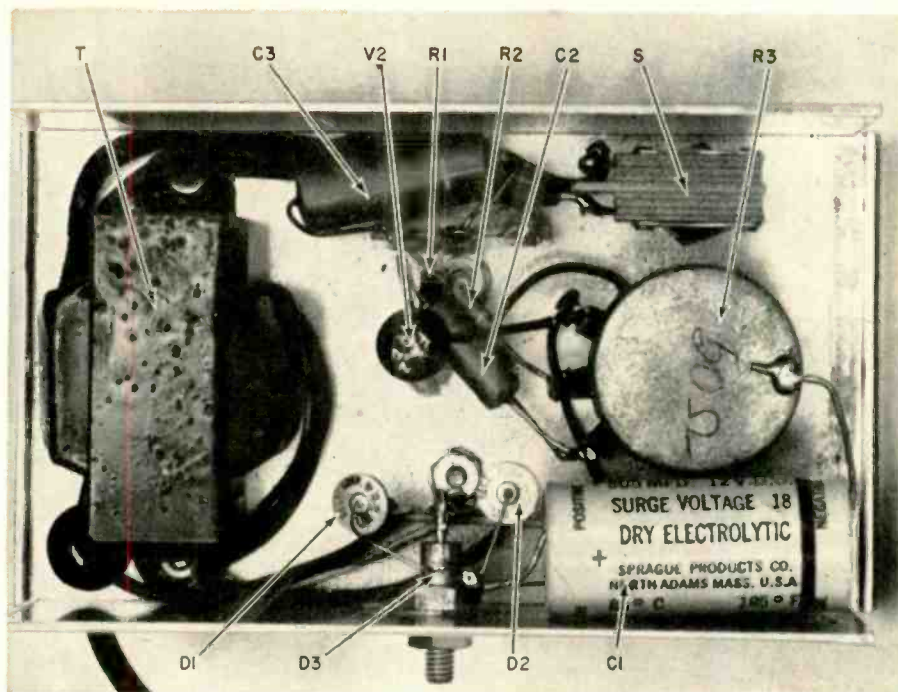

With the back of case removed, parts layout is revealed.

battery voltage will naturally drop. It is likely that the combination of the potentiometer in parallel with the internal resistance of the battery would lower the source impedance to less than 1 ohm. Although this gives us a low source impedance, it obviously discharges the battery in a very short time.

### Electronic supply

Although batteries might seem to be a convenient power source, an electronic power supply is more satisfactory. Fig. 4 shows a very simple device that has a very low output impedance.

Both line and load regulation is excellent. To duplicate a single dry cell, less than 2 volts is required. A center-tapped 6.3-volt filament transformer serves as the power transformer. Two replacement type silicon rectifiers are connected in a full-wave circuit. The voltage output from the rectifier is regulated by a 3.9-volt Zener diode.

Since the regulation point (out of the rectifier) is higher than needed for the intended application, series regulator transistor V1 is used to drop the output terminal voltage. The gain of this transistor (and therefore the output voltage) is varied by control transistor V2.

If load current decreases, and volt-

age across R3 increases, more negative bias is applied to V2. This, in turn, causes the junction resistance of V2 to decrease, thereby reducing the bias applied to V1. Transistor V1, then increases junction resistance, which returns the output voltage to near its original value.

Ripple can be a serious problem in power supplies for semiconductor circuits. Most semiconductor devices are voltage-sensitive and even a tiny periodic variation in supply voltage will affect their performance.

In addition to regulating changes in dc (just described), the response time of the regulator circuit is fast enough to cancel hum. Any ripple voltage which appears across the load is coupled to the base of V2 through capacitor C2. For example, let's say

there is a negative-going alternation at the junction of V1 and C2. This signal, coupled to the base of V2, increases the current flow in V2 and reduces it in V1, as before. This increase tends to counteract the ripple. With the component values shown, the correction is almost complete, which brings about near-perfect hum cancellation. The output ripple and impedance are so low that a 500-µf capacitor connected across the terminals will not reduce the remaining ripple noticeably!

### Let's build one

The layout of the adjustable power supply can be seen in the photos. The collector of the current-passing (series regulator) transistor is made common ground so V1 can be mounted directly to the chassis without insulating washers. A 3-lug terminal strip is mounted under each lug securing transistor V1. The terminal closest to the ac switch provides tie points for one side of the line cord, the ground end of C3 and R1, and V2's base. The other strip is used for the junction of the transformer and the rectifiers, the transformer center tap and the Zener diode ground. For convenience, C1 is grounded to the frame of R3.

The transformer loafs along since each half of the winding supplies power on alternate half-cycles. Any center-tapped unit supplying 600 ma or more is quite adequate.

The Zener diode is also much larger than required for the job since it can dissipate 3.5 watts. Almost any Zener diode which regulates between 3 and 4 volts will work in this supply.

The experimenter can also use any one of several transistors in this power supply. A few of the types I tried are given in the parts list. The current-passing transistor, V1, should have a low saturation resistance. The control transistor, V2, should have a beta of at least 30.

I used a General Electric 2N43-A controlling a Tung-Sol TS-612, as shown in the photograph. The transistors shown in the parts list were all tried and worked equally well.

### Final setup and operation

The supply is almost foolproof, but there are several components you can adjust for maximum performance. The optimum capacitor values in the hum-cancelling feedback network (C2 and C3) appear to be different for some transistor types.

To obtain an absolute minimum of hum and ripple, connect the power supply terminals to the input of a high-gain audio amplifier. Set the VOLTAGE ADJ potentiometer for 0.6-volt output and try substituting various capacitor values for C2 and C3. You will find definite values which give minimum ripple as heard in the amplifier.

The supply is used just as if it were a variable battery. With the knob fully counterclockwise, the output voltage is approximately 0.1 volt. As the knob is rotated clockwise, voltage increases to a maximum of 2.5, somewhat higher than the average dry cell. END

- R1, R2—1,000 ohms, 1/2 watt
- R3—pot, 50 ohms, wirewound
- C1—500 µf, 12 volts, electrolytic
- C2—4 µf, 6 volts, electrolytic
- C3—.033 µf, 600 volts, paper
- D1, D2—silicon rectifiers, 400 volts, 200 ma (International Rectifier 2E4 or equivalent)
- D3—Zener diode, 3.9 volts (International Rectifier IN1589 or equivalent)
- J1, J2—3-way binding posts
- S—3-pt toggle
- T—filament transformer: primary, 117 volts; secondary, 6.3 volts ct, 1.2 amps (Triad F-14X or equivalent)
- V1—2N307, 2N301, 2N256, 2N243-A, TS-612
- V2—2N43-A, 2N217, 2N407, 2N408, 2N1380
- Chassis, to suit
- Miscellaneous hardware

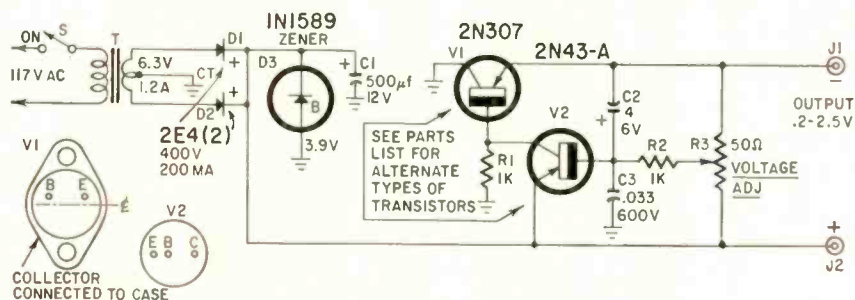

Fig. 4—Circuit of the electronic dry cell.

# ELECTRONIC WATCH REPAIR

*New field for the technician  
—keep the watchmaker's elec-  
tronic equipment up to par*

**A**S first electrical and now electronic wristwatches appear on the market, the fields of the watch repairman and the electronic technician come closer together, indeed overlap. We have had electronic watch timers for some time<sup>1</sup> as well as ultrasonic watch cleaners.<sup>2</sup> Now an electronic test instrument designed for testing and adjusting a watch has appeared. Manufactured by American Time Products, it is intended to check the new Bulova Accutron electronic watch.

Earlier watches simply replaced the old mainspring with a power cell. They retained the hairspring, balance wheel and escapement of the spring-wound watches. The Accutron abandons the traditional balance wheel, using that acknowledged standard of frequency, the tuning fork, both as regulator and driver. Since the fork is driven by a transistor switch, Accutron repair is a job that requires the knowledge and skill of the electronic technician rather than that of the old-time watchmaker.

The tuning fork is the heart of the

design of the Accutron, as the new device is called. Electrical energy delivered and controlled by the circuit causes the fork to vibrate. These vibrations are converted mechanically to rotary motions and, in turn, transmitted through a gear train to the hands. (See Fig. 1.)

The tuning fork is about 1 inch in length. On the tip of each tine is a magnet assembly which consists of a cuplike piece of magnetic material and a conical-shaped magnet mounted within the cup—actually a small pot magnet, similar to those on loudspeakers.

A strong magnetic field lies between the magnetic cone and cups. Coils of wire shaped to match the conical magnet are interposed in these magnetic fields. An alternating voltage is induced in the coils as the magnets vibrate.

As the tuning fork vibrates at 360 cycles per second, a voltage is induced in the coil in the transistor's base circuit. This voltage, interacting with a capacitor and resistor, together with the power-cell voltage, causes the transistor to become conductive for a split second during each vibration of the fork. Whenever the transistor, acting as an electronic switch, is switched on, it allows a surge of current to reach

the driving coils. These pulses of current maintain the vibration of the fork at 360 cycles.

On one tine of the fork is a tiny fingerlike spring tipped by a tiny jewel. This is termed the index finger. Its job is to push on the ratchet teeth of an index wheel 360 times per second—once for each vibration of the fork. The pushing force rotates the index wheel. The wheel, which is smaller than a pinhead and about half a hair in thickness, drives the wheel train that moves the hands of Accutron. A similar jewel-tipped spring finger serves as a pawl to hold the wheel ready for the next push.

The design of the indexing mechanism permits a wide range in the extent of tuning-fork vibratory motion (which results in a wide range of travel of the index finger) before it would tend either to advance the wheel more than one tooth or not advance it at all. Any advance other than one tooth for each tuning fork vibration, of course, would make the hands run too fast or too slow. If amplitude tends to deviate from a specific designed-in value, the electronic circuit senses this and instantly returns the fork to its proper range of amplitude.

<sup>1</sup>"Modern Watch-Rate Recorders," RADIO-ELECTRONICS, August 1953, page 26  
<sup>2</sup>"Sound Does the Cleaning," RADIO-ELECTRONICS, July 1959, page 30.

**Fig. 1**—Highly simplified drawing shows internal arrangement of the Accutron. Essential mechanism is clearly illustrated. When testing an Accutron, the power cell is removed and a power adapter from the test unit is connected in its place.

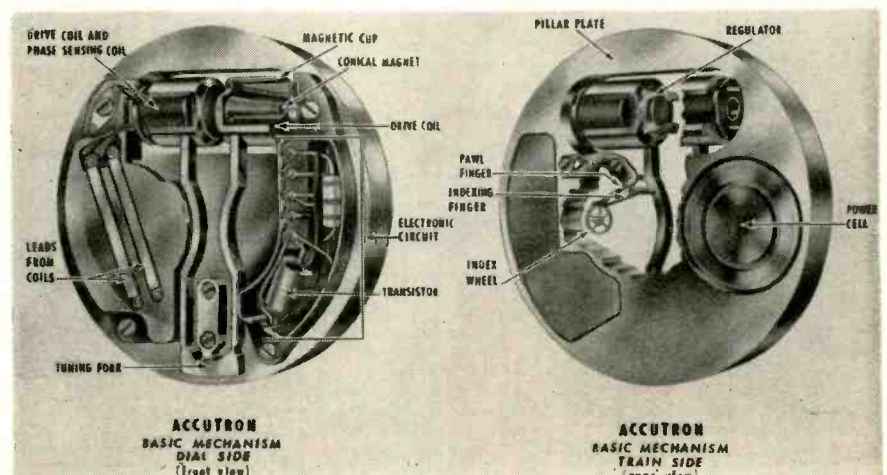



The tuning-fork assembly and the electronic circuit are modules which can be removed and replaced by a jeweler if they are damaged.

Accutron is powered by a tiny 1.3-volt mercury cell guaranteed to last at least 1 year.

### The watch checker

The meter used for checking the watch has three functions:

- ▶ To check the voltage of the Accutron power cell.
- ▶ To check the current drawn by the electronic circuit of the watch.
- ▶ To supply voltage, both at normal and at reduced levels, for checking and adjusting the indexing mechanism.

One important requirement was so to design the meter as to have protection against damage to the meter movement, and further to safeguard against the needle slamming violently against its stop, even though that might not produce damage. (The thinking here is that, if a watchmaker accidentally shorted his test leads and saw the needle slam, he would be inclined to believe his instrument's accuracy had been impaired. Consequently a circuit was evolved which provides such safeguards.)

The safety is provided by purposely having a high-resistance dc supply. Even when shorted, current through the meter is limited to only slightly over full-scale current.

In checking a movement, the first operation is to insert the power cell taken from the watch into the meter to check its voltage. If the voltage is outside the OK limit on the scale, the cell is replaced.

The next step is to check the Accutron operation. With the checked power cell in the test set, and the test-set connector replacing the power cell in the Accutron, switch S1 is moved to position 2 MICROAMPERES.

Transistor V and coil L with its interwinding capacitance make up a Hartley type oscillator. Frequency of oscillation is approximately 100 kc; the amplitude between collector and ground is twice the supply voltage or 2.6 volts peak to peak. D1 rectifies this voltage, charging capacitor C2 to the peak-to-peak voltage of -2.6.

With switch S2 in NORMAL AMPLITUDE position, 2; switch S1 in MICROAMPERES position, 2, and no plug in jack J1, the bleeder across charged capacitor C2 consists of R3, D2 and the power cell in series. Diode D2 is forward-biased, thus the drop across it is close to 0.1 volt. The bleeder current is approximately 12  $\mu$ a, and the voltage at the junction of R3 and D2 is -1.4 with respect to ground, charging capacitor C3 to that voltage.

When an Accutron is inserted in the Accutron connector and the plug is inserted in jack J1, the bleeder across C3 consists of the meter and the Accutron in series. The meter reads approximately 6.2  $\mu$ a. The current through R3 divides so that 6.2  $\mu$ a goes through the meter branch and approx-

imately 6  $\mu$ a goes through diode D2. The balance is arrived at by the condition required to keep D2 biased in the forward direction. If more than 12  $\mu$ a were to flow in R3, the voltage at the junction of R3 and D2 would become more positive than the negative end of the power cell and diode D2 would become reverse-biased, cutting off the branch through D2. This, therefore, establishes the maximum current through R3 for keeping the power-cell in the Accutron circuit. The Accutron sees a low-impedance source consisting of the series string of the meter movement, forward-biased diode D2 and the power cell.

If for some reason the Accutron circuit draws more than the 12- $\mu$ a total current, the voltage at the junction point of D2 and R3 becomes less negative than -1.3 volts, cutting off D2. Under this condition, the source imped-

ance for the Accutron is high, limiting the maximum current through the meter, which cannot exceed 26  $\mu$ a when completely shorted. For normal operation, the needle indicates in the safe region, 5.8 to 6.5  $\mu$ a.

For low-amplitude operation, switch S2 is moved to position 1, introducing voltage divider R2 and R4 across the power cell. Thus the divided voltage is used to actuate the Accutron. For this condition, the current is reduced but should not fall below 4.5  $\mu$ a. This simulates the condition of a power cell which is close to the end of its life but is still usable. The Accutron must operate satisfactorily under this condition.

The circuit was developed by the Bulova Watch Co., Jackson Heights, N. Y., and as stated above, the meters are made by American Time Products Inc., a Bulova subsidiary. END

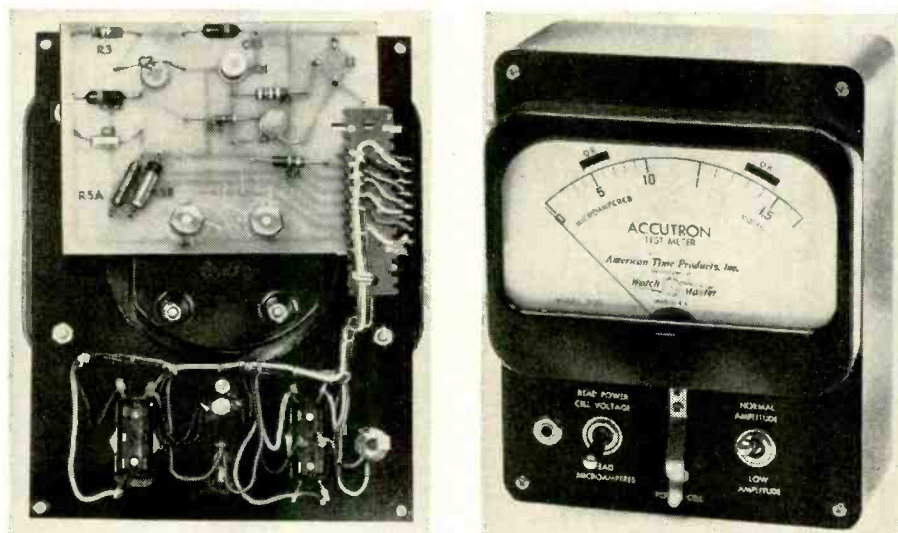

Front and rear views of Accutron tester.

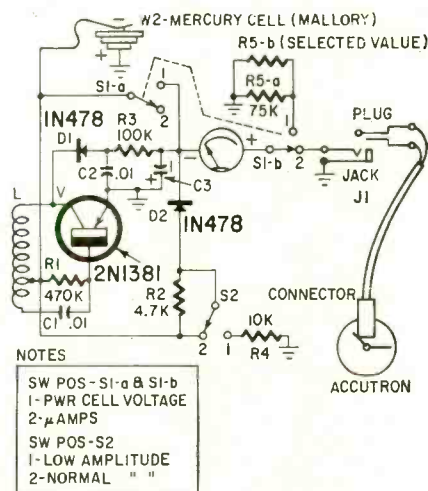

Fig. 2—Schematic of Accutron test set.

# Two of the more recent semiconductors open a whole new field in switching and thyatron applications

By GENE JACKSON

**D**URING the last decade, transistor development has progressed rapidly and received world-wide publicity. This is as it should be, but other developments in the semiconductor field should not be neglected. Some of these devices promise to play a very important part in the electronics of the future. Two examples are the four-layer diode and a modification of this basic device—the controlled rectifier.

The ordinary junction diode consists of a layer of P-type crystal joined to a layer of N-type crystal. It can be forward- or reverse-biased. With

presented by two transistors connected as shown. Notice, too, that the p-n-p transistor is correctly biased. The emitter-to-base junction (J1) is forward-biased and the collector-to-base junction (J2) is reverse-biased. Bias conditions occur in the n-p-n section are also correct. It is shown that  $I_{B1}$  equals  $I_{C2}$ , and  $I_{C1}$  equals  $I_{B2}$ . If this unit can be caused to begin conduction and increase the current through it to a certain critical point, this internal feedback mechanism sustains conduction.

To explain this, we can further state that any transistor has a value of alpha

in the p-n-p section are holes and they move from positive to negative polarities, this current flow is shown by a dashed arrow. The current crossing J2 is  $\alpha_1 I_T + \alpha_2 I_T$ . Because of minority carriers, we cannot ignore the value of  $I_{CBO}$  or reverse current present to some extent in all semiconductor devices.

Therefore the total current across J2, which is actually the current through the entire device, can be shown as:

$$I_{J2} = I_T = \alpha_1 I_T + \alpha_2 I_T + I_{CBO}$$

$$\text{And: } I_T(1 - \alpha_1 - \alpha_2) = I_{CBO}$$

$$I_T = \frac{I_{CBO}}{1 - (\alpha_1 + \alpha_2)}$$

This indicates that if  $\alpha_1 + \alpha_2$  equals unity, the current in the diode is limited only by the external circuit.

If  $\alpha_1$  and  $\alpha_2$  are close to zero, the current through the diode is approximately equal to  $I_{CBO}$ . Because J2 is reverse-biased and base current from both equivalent transistors must in some way cross this junction, there is only

## Four-layer diodes & controlled rectifiers

### What are they?

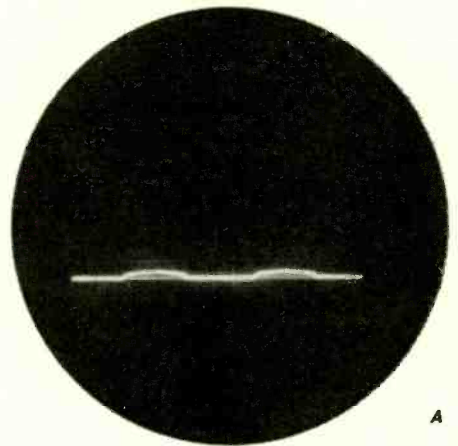

forward bias, the P-type material is made positive with respect to the N-type and the diode conducts. When the diode polarities are reversed, reverse bias results and very little current flows.

The four-layer diode has two N-regions or layers and two P-regions as shown in Fig. 1. Under normal operating conditions, the center p-n junction is reverse-biased and the outer p-n junctions are forward-biased. To illustrate the effects of this arrangement, an equivalent structure is shown in Fig. 2.

Here, a four-layer diode is repre-

(a). This is indicated by:

$$\alpha = \frac{I_C}{I_E} \text{ (disregarding minority carriers)}$$

$$\text{Or: } I_C = \alpha I_E$$

Alpha is the portion of the majority carriers leaving the emitter and reaching the collector. In an ordinary transistor, alpha is made as large as possible to get the highest forward-current transfer ratio or current gain.

Referring again to Fig. 2, the majority carriers in an n-p-n transistor are electrons. This is shown by the solid arrow. Because the majority carriers

this leakage current available unless some method is found for "triggering" the unit. This nonconducting condition of the four-layer diode is the "blocked" state.

Some method must be found to increase alpha if this device is to be useful. Two methods are generally used. One is to increase emitter current directly; the other is to increase the collector voltage and thus indirectly the emitter current. As in ordinary transistors, alpha or current gain increases with emitter current. Fig. 3 is a curve of alpha vs emitter current.

The author wishes to thank the Public Relations Div. of Texas Instruments Inc. for its permission to use data from the May 1960 issue of Application Notes as a source of information for material in this article. Many of the circuits discussed were constructed and results verified in the Training Aids Laboratory of the Educational Services Section of Convair, a Division of General Dynamics Corp., Fort Worth, Tex.

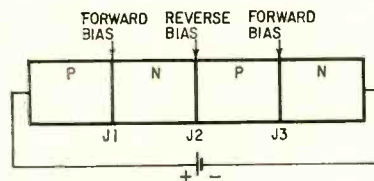

Fig. 1—Structure of a 4-layer diode.

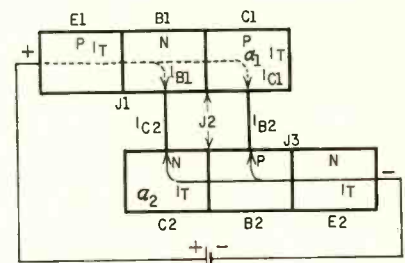

Fig. 2—Equivalent diagram shows two transistors connected to form a 4-layer diode.

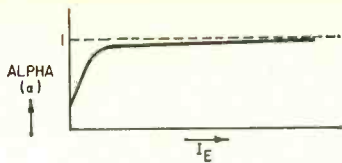

Fig. 3—Alpha vs emitter current for a 4-layer diode.

If the voltage across the entire unit is increased to a certain critical point, the center junction, J2, breaks down (triggers) and allows reverse current to flow through it, and thus emitter current and alpha increase.

The effect of this phenomenon is that the diode continues to conduct even if the high breakdown voltage is decreased. The device has switched from its "blocked" condition to its "on" condition. It will remain in this state as long as the current through J2 is great enough to cause  $\alpha_1 + \alpha_2$  to be equal to

Fig. 4, the unit then acts like any reverse-biased diode. If the voltage reaches the breakdown point or Zener voltage, current through the device increases. However, the voltage across the diode does not decrease, and it could be used for voltage regulation. This is not, however, its most useful application.

### Typical application

Perhaps a discussion of a typical application of this diode would be useful in pointing up its possibilities. Fig. 5 is a partial schematic of a circuit using such a diode.

In Fig. 5, R1 and R2 act as a voltage divider across the negative 100-volt supply so that approximately -60 volts appears at point A. As the breakdown voltage of the four-layer diode is 80 volts, it does not conduct until additional voltage is applied across it.

When a negative-going signal is applied to V1's control grid, a positive pulse of over 20 volts amplitude ap-

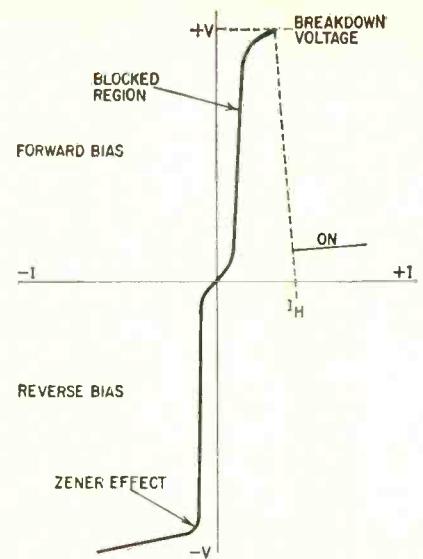
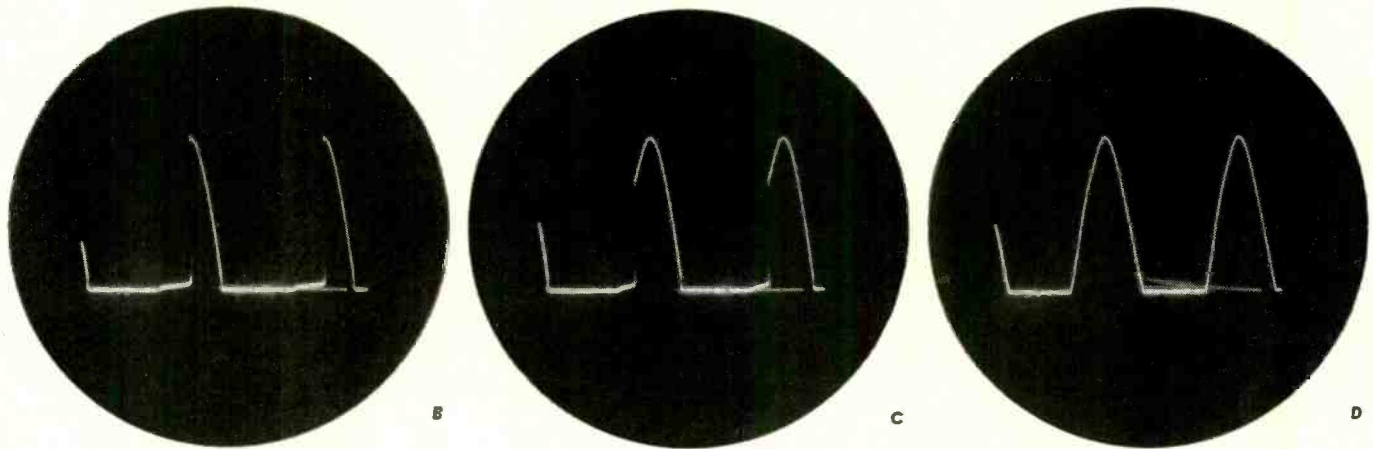

Fig. 4—Forward-bias voltage vs current for a 4-layer diode.



unity. The current at this time is limited almost totally by the voltage applied and the resistance in the external circuit, as the resistance of the diode is now extremely low. The minimum current that must flow through J2 and also in the external circuit to maintain this "on" condition is called the holding current,  $I_H$ .

This plot of forward-bias voltage current is in Fig. 4.

If the polarity of the voltage across the diode is reversed, J1 and J3 are reverse-biased and J2 is forward-biased. The effect then is similar to two reverse-biased diodes in series. As shown in

Controlled rectifier in circuit of Fig. 8 produces these scope patterns: a—R1 set for zero gate current. There is no anode current. Low-amplitude waveform is result of minority carriers only. b— $I_G$  is large enough to cause some conduction, but not during the entire positive alternation. c—A still higher value of  $I_G$  causes this waveform. d— $V_G$  has been advanced until the firing point occurs very early in the half-cycle.

pears at V1's plate and across T1's secondary. This increases the potential difference across the diode past 80 volts and it conducts. At this time the resistance and the voltage drop across the diode become very low. Effectively, the secondary of T1 and C, which is charged to the polarity shown, is applied directly across T2's primary. Thus, a pulse of slightly more than 20 volts results in a signal of more than 80 volts across T2's primary. Although the four-layer diode cannot be called an amplifier in a true sense, it actually amplifies the input signal.

The diode will very shortly block or go to a nonconduction state because, when C has discharged and the trigger input at T1 has elapsed, there is not enough current ( $I_H$ ) to hold D in a conducting state. R1 is chosen so that D's  $I_H$  is greater than the current

through R1 with a 100-volt drop across it. The circuit then recovers, C again charges to the polarity indicated and another input pulse may be applied.

### The controlled rectifier

Another method of turning this type of device "on" without reaching the breakdown voltage across the diode is used in the controlled rectifier. A structure diagram of this unit is in Fig. 6. Fig. 6-a shows the necessary electrical connections and polarities. Fig. 6-b is the equivalent structure diagram.

When operating below the breakdown voltage, the device is in its blocked state and only  $I_{000}$  flows in the circuit. However, we have now added another connection to this modified four-layer diode or controlled rectifier—the gate lead connected to the center P-region.

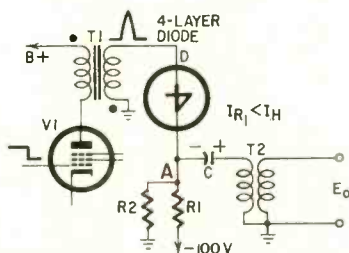

Fig. 5—Possible circuit uses 4-layer diode switch.

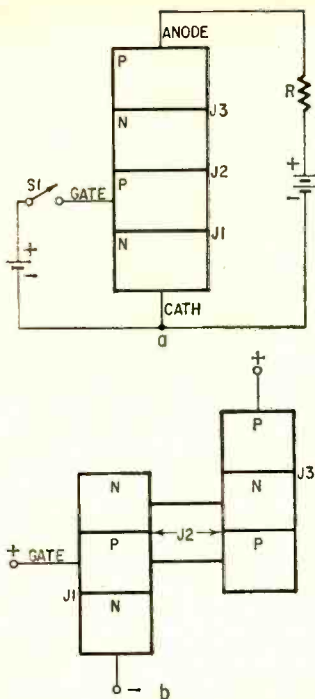

Fig. 6—Controlled-rectifier construction and 2-transistor equivalent arrangement.

If a positive voltage is applied to the gate lead, current flows in this part of the circuit as this represents forward bias for J1. Because of transistor action, some of the electrons from the cathode drift across the first P-region (actually the base region for the equivalent n-p-n transistor) and enter the second N-region by diffusing across J2. Because J3 is forward-biased, electrons and holes combine in the area of J3. This results in electrons leaving the anode circuit from the top P-region and causing holes to form here. Thus, current has been increased through the device.

Furthermore, as the holes formed near the anode lead drift across the P-region and cross J3, some combine with electrons from J2 and some diffuse across J2 and enter the next P-region. Transistor action has now been accomplished in both equivalent transistor sections. As the current through the device is thereby increased, alpha or current gain of both sections increases. This results in further increase in current and alpha until the unit saturates.

We have seen that, once the gate

current reaches a certain point, the device turns "on" and the current through the controlled rectifier is limited only by the voltage and resistance in the external circuit. This is similar to the action of a thyatron where the grid voltage controls the firing point. The controlled rectifier has the advantage of a very small voltage drop across it when conducting. This means that a controlled rectifier can be used where a thyatron might be impractical.

Another advantage of this arrangement is that a small gate current,  $I_G$ , can cause a large change in anode current. This action is shown graphically in Fig. 7.

If there is no gate current, the voltage across the device must be increased until the breakdown voltage is reached to cause the device to turn "on". The current then increases and the voltage across the unit is small. As the gate current is increased, the controlled rectifier will fire with less voltage across it. This is indicated in Fig. 7 where  $I_{G0} < I_{G1} < I_{G2} < I_{G3} < I_{G4}$ .

#### Simulation circuit

A simple circuit that can be used to demonstrate the characteristics of the controlled rectifier is shown in Fig. 8. A Texas Instruments 2N1595 controlled rectifier diode is used.

If a rectifier with high enough breakdown voltage ( $B_V$ ) and power dissipation ratings is used, the transformer may be eliminated and the line voltage connected directly across D. Be sure that the maximum permissible gate current is not exceeded at any time.

With R1 set for zero gate voltage, there is no anode current. This is shown in Fig. 9-a. The low-amplitude waveform is the result of minority carriers only ( $I_{CBO}$ ). The scope's vertical gain had to be increased for this photograph so this conduction would show up.

As potentiometer R1 is adjusted so that gate current flows, a point is reached where the diode begins to con-

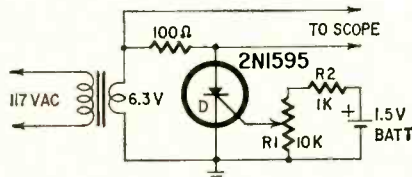

Fig. 8—Demonstration circuit using a controlled rectifier.

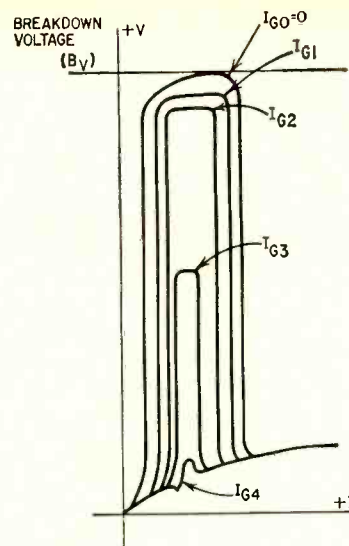

Fig. 7—Effect of  $I_G$  on anode current for a controlled rectifier.

duct on part of the forward voltage alternation. This is because, with a higher gate current, the rectifier turns "on" with a smaller forward voltage. Fig. 9-b shows a condition where  $I_G$  is large enough to cause some conduction, but not during the entire positive alternation. Fig. 9-c illustrates a still higher value of  $I_G$ .

R1 can be adjusted to change the firing point while observing the result on the oscilloscope. As  $V_G$  is increased, the firing point occurs earlier in the half-cycle until the waveform of Fig. 9-d results. This is a typical half-wave rectifier output. Notice that, if the firing does not occur on the positive-going portion of the positive alternation, it does not occur during the negative portion as the voltage across the rectifier is now decreasing. There is a small irregularity in the extreme lower trailing edge of the rectifier output. This is caused by the current through the rectifier dropping below the holding current of the device.

The controlled rectifier must be turned "on" again during each positive alternation as it will "block" during each negative alternation and the entire process is thereby repeated.

An interesting variation of this circuit is to substitute an alternating-current source for the battery. If the gate goes positive at the same time as the anode, the unit conducts. If not, the device remains cut off. This suggests many possibilities of using the p-n-p-n controlled rectifier as a phase detector or servo system control device, etc.

As the electronics industry becomes more aware and informed of p-n-p-n rectifiers, many additional applications will be uncovered. The uses of controlled rectifiers in the future are limited mainly by the imagination and ingenuity of designers. Controlled rectifiers are already being used in control circuits, pulse-generating systems, switching circuits and other such applications. As the state of the art is extended, more and varied circuit functions using these devices will be coming into general use.

END



"You said you wanted a cheap intercom!"

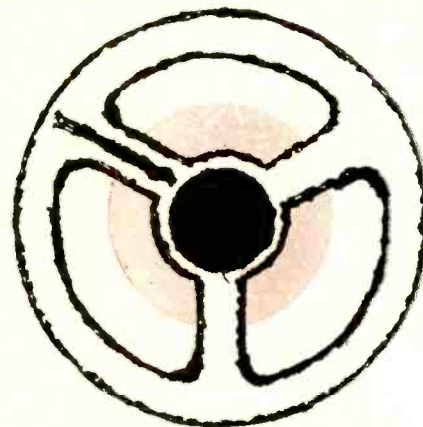
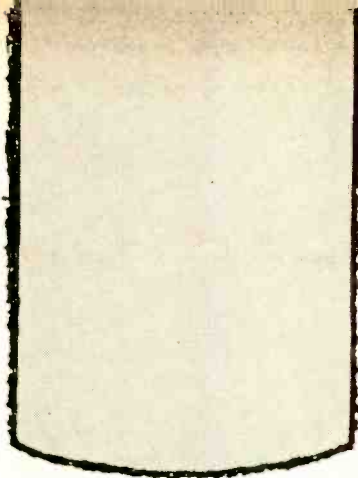
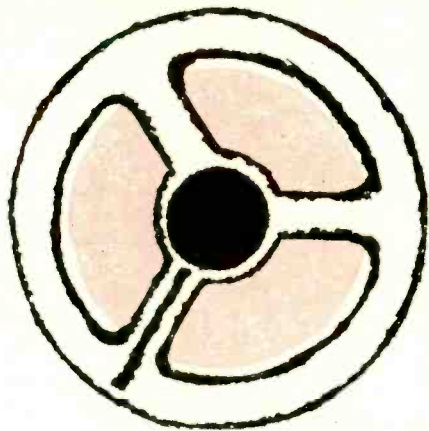

# SERVICING TAPE RECORDERS

*The electronic portion of the tape machine is the service problem this month*

By **JACK DARR**  
RADIO-ELECTRONICS SERVICE EDITOR

**T**APE recording has become a big business. Seventy-six manufacturers are listed in my latest service-data index, and this includes only home type recorders. Others make professional recorders for broadcast radio, TV and telemetry work. However, this article will deal only with home tape recorders, since they are what the average technician sees most.

In the course of our daily work, we made a most disquieting discovery. In service data on these machines, some very useful information has been either omitted or given in such a way that it is unusable by the service technician with standard shop equipment!

## Magnetic recording

Let's run briefly over some of the basic theory first.

The whole thing started back before 1900, when a happy Dane named Valdemar Poulsen discovered that sound signals could be recorded on a piece of iron wire.

Today magnetic tape has replaced the wire. It is usually an acetate or Mylar plastic,  $\frac{1}{4}$  inch wide and about .0015 inch thick. It is coated with a red ferrous oxide to a thickness of .0006 inch. Mylar bases can be thinner, allowing more tape to be wound on the same size reels.

How can we get a magnetic field varying with the audio signals? We feed the signal through an amplifier to raise it to the level needed and then

through a coil of wire, past which the tape is being pulled (Fig. 1-a). The coil has an iron core with a gap in it to concentrate the magnetic field where we want it. This is the recording head. The narrower the gap (Fig. 1-b), the higher the efficiency of the head, especially at high frequencies. Early heads used wide gaps as compared to later types. In modern heads, the gap is as narrow as .001 inch, and some high-fidelity playback machines have gaps of only .00025 inch!

How do we get the signals back off the tape and convert them to sound? Well, if we pass a conductor through a magnetic field, a current is generated in it. So, if we move a magnetic field (on the tape) past a stationary coil, we'll generate currents in the coil. Put these through an amplifier and speaker, and the sound is heard again.

Now, with this too-brief discussion of fundamentals out of the way, we can get down to more practical work. This month, we will discuss the electronic section, or as much of it as we can get in. Next time we'll hit the mechanical

section, and, then, special tests, service techniques and peculiarities found in commercial tape recorders.

## The amplifier

As we said, the major part of the electronic section of the tape recorder is the audio amplifier. Up to a certain point, it is a conventional voltage amplifier, operating in class A (Fig. 2).

The tubes used are specifically designed for low noise and hum. Their internal structures are heavily braced to avoid any tendency to microphonics. This is essential in this application. Tape recorder amplifiers must operate on the same chassis with one, two or three electric motors, belts and assorted moving hardware, which gives the amplifier a lot of unavoidable vibration. Therefore, the input tube (the most sensitive) must be completely free of any microphonism for a clean recording. Shock-mounted sockets are used on this tube in some models.

## Amplifier testing

Now, let's check a recorder. I'm not

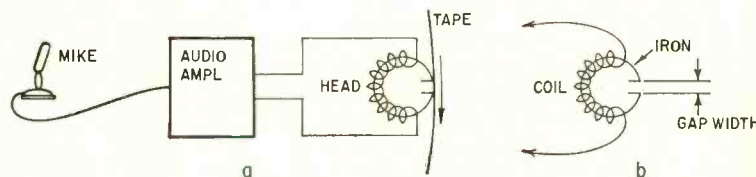

**Fig. 1-a**—How we put a magnetic field on the tape. **b**—Width of gap in iron core determines efficiency of recording head.

going to tell you to test the tubes and measure the dc operating voltages on each stage. You're supposed to have that already done! Let's assume that we have a tape recorder that isn't working right electronically. (Tape transport OK, just won't record.) So, we begin with the microphone.

Mikes used with these instruments are usually small crystal types, with an output of about -55 db. This is a bit higher than the output of broadcast and high-grade PA mikes, which run about -70 db.

There are several quick-checks for a mike. About the simplest is holding the mike to your ear and applying an ac signal through a blocking capacitor. You should hear the signal reproduced in the mike. Practically all mikes of this type will talk back—they will make sound as well as pick it up. Never connect dc directly to a microphone. Some types will be ruined by this procedure.

If the mike is dead, check the cable and connections.

Mike troubles are broken cables or loose connections. These usually turn up within 6 inches of the plug or mike, as these are the points of most flexing of the cable. If one end has been broken, it's a good idea to cut off about 6 inches of the other end and rework it too.

(Usually, that is!) Parts replacement follows standard printed-circuit practices.

Signal-tracing is still the quickest way to locate bugs in any piece of electronic equipment. The quickest way in a tape recorder is to set up the instrument, plug in the mike and set it to record. (Incidentally, if the motor annoys you, disconnect one of its leads to stop it!)

Connect the output of an audio signal generator to a single earphone or small PM speaker, set it about 400 cycles. (This frequency is picked as it is not affected by either low- or high-frequency compensation networks.) Place the mike close to the speaker to pick up the sound (Fig. 4). (If the mike is a small one, it can be laid face up on the bench, and the speaker placed cone down on top of it.) If the mike is defective or missing, you can apply the audio test signal directly to the input of the amplifier.

However, you'll have to be careful not to overload the input stage, which is always very high gain. This can cause very severe distortion and lead you to look for nonexistent troubles.

Set up a temporary voltage divider as shown in Fig. 5. Ordinary resistors of almost any size will do as long as

Sometimes a square-wave signal can be used to advantage but, for routine gain checking, a sine wave is fine. Notice the increase in pattern height as you go from grid to plate on each tube. This will tell you whether the stage has enough gain. This is also hot stuff for locating open coupling capacitors and bad switches!

In a conventional amplifier, you would expect the signal level to increase as you go from input to output. However, in a tape recorder amplifier, there are two special factors.

First, the recording amplifier uses equalizing networks to reduce the low-frequency and increase the high-frequency response to give a standard recording curve. The networks reduce signal level, and stage gain may seem to disappear. Because the networks are not always in the same places, before attempting to service a stage for "no gain," make sure that a compensation network is not causing the effect. Do not permanently disable or bypass these networks. They are necessary for the proper operation of the recorder.

Second, the output of the recording amplifier is used to drive the recording head, an inductive load. Connected directly to the tube plate through only a coupling capacitor, too much current would flow at low frequencies where the head has practically no impedance and almost shorts the output, and too little current would flow at high frequencies where the head impedance may rise to 50,000 ohms or more. The normal practice is, therefore, to add a series resistor as a constant-current device. Typical values are from 47,000 to 270,000 ohms. With the constant-current resistor, there is very little difference in current flow whether the head is shorted (low frequencies) or open (high frequencies).

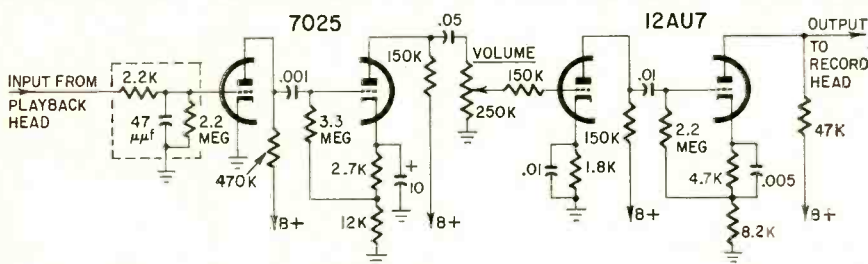

Fig. 2—Typical class-A voltage amplifier found in home-type tape recorders.



Fig. 3—Part of printed-circuit amplifier used in typical modern tape recorder. All parts are visible, and test points can be reached with long, thin test probe or extension.

There is a distinct possibility that several strands are broken at that end, and it may save you a callback!

With the mike checked out, let's go through the amplifier. After voltage readings have been checked, you can go through it with the low-capacitance probe. Most of the later-model amplifiers run pretty heavily toward printed circuitry, like the one in Fig. 3, so you'll probably have to use an extension on your probe tip. However, these amplifiers do have one advantage. All the test points you want are at least visible, if not too accessible, and you can run a full test on the amplifier without removing the recorder from the case.

their ratios are right. For example, the 100,000- and 1,000-ohm combination shown will apply about 10 mv to the input, if 1 volt is applied across the two from the generator. Other ratios can be used, as long as the total voltage applied to the input doesn't exceed about 10 mv, which is close to the output voltage you'll get from one of the small crystal mikes.

Now you're ready to go. Begin by locating and removing the bias oscillator tube to avoid interference in readings from bias leaking about the amplifier. Then check the waveform and value of the applied signal, just to be sure. Trace this through the amplifier.

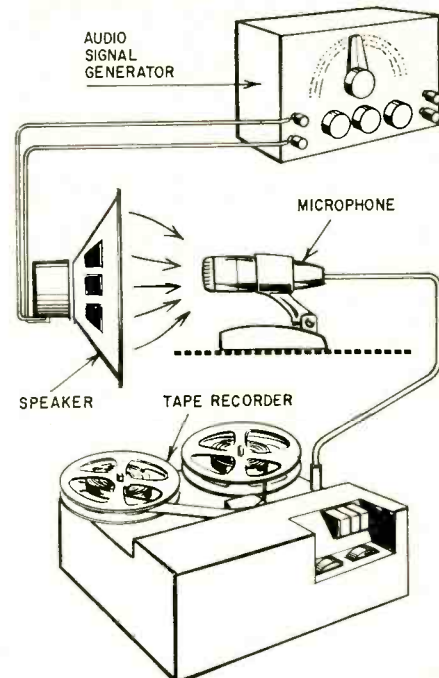

Fig. 4—Quick test setup for tape-recorder amplifiers. Speaker or earphone is connected to signal generator. Mike is placed close to pick up sound.

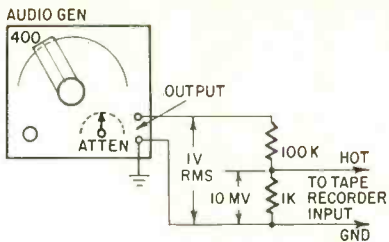

Fig 5—Voltage divider used to reduce input signal to prevent overloading.

After we get to the recording head, things begin to happen. What happens to our nice smooth sine-wave signal shouldn't happen to a dog! On the recording head, the same signal looks something like Fig. 6! This waveform was taken by connecting the probe directly across the recording head, after killing the bias by pulling the oscillator tube. The two waveforms of Fig. 6 are from different makes of well known recorders. All of those tested showed

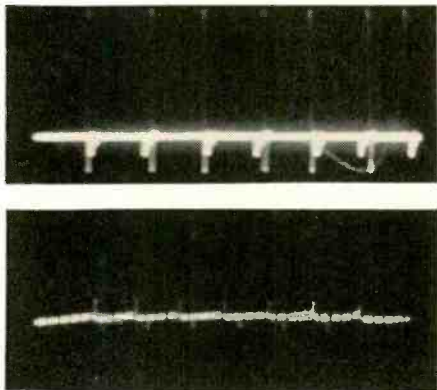

Fig. 6—Waveform of signal taken across recording head. Note heavy integration of signal. The two waveforms are of the same frequency signal, but were taken from different recorders.

basically the same waveshape, so we show only these two.

What's happened to our sine wave? Because of the nature of the load to which the signal is being fed, like the deflection yoke of a TV set, we must have a trapezoidal voltage waveform to produce a sawtooth current waveform. But we have, in the recording head, an almost pure inductance. So, to get a sine-wave current waveform in the head which will give us the best results in making the recording, we must feed it a "mess of spikes" instead of a nice pure sine wave.

The part values shown in Fig. 7 do not represent any particular amplifier. They're a sort of composite of several, to make up an output stage incorporating frequency compensation and bias coupling. Actually you'll have very little use for the waveform of Fig. 6; it was just thrown in to let you see what it actually looked like. Fig. 8 will be much more useful. This is a typical positive bias-signal waveform seen across the recording head with a low-capacitance probe. Signal frequency here is the same as that used before—400 cycles. Notice that the complete signal tends to show somewhat of a square-wave shape, with the bias included.

This is the actual signal that impresses the varying magnetic fields on the tape. The major part of this waveform is bias, at about 30 kc. The depth of modulation seen here is higher than what you should see in an actual test. We stepped the input signal up to a high level to show the "modulation" in the photograph. So, if your recorder doesn't show quite the depth of modulation, don't worry. Correct modulation should be just barely visible on the bias waveform.

Actual voltage readings in this important circuit depend on frequency of bias oscillator, type of recording head used, and the input impedance of the voltmeter, so are not usually a factor in servicing.

Actually, I feel that we can get all the information needed using a scope and the proper probe. They will quickly tell us the three things we must know about the output of the amplifier and allied circuitry: 1—Is there bias present? 2—Is output signal reaching the recording head? 3—Does the amplifier have enough gain?

Actual bias and signal voltages on commercial recorders, as measured on several typical machines, run about like this: bias, 30–50 kc, about 130 to 150 volts peak to peak. Signal voltages, no bias present, from 5–50 volts peak to peak. Readings will vary quite a bit with head design, oscillator frequency and type of instrument used to measure. I'd suggest that you make your own set of voltage readings on every tape recorder you run into, and note them on the service data for future reference.

### Bias-erase oscillators

We've been forced to refer to bias oscillators in some of the foregoing material before we had a chance to talk about them. Several oscillator circuits are in common use in tape recorders. They fall into two main classes: In some machines, the bias oscillator and output stage are combined in a single tube, usually a power pentode such as a 6AQ5. By switching, the tube operates both as an oscillator and audio amplifier. In some circuits it is used as output to the recording head and bias oscillator simultaneously! In fact, the circuit of Fig. 7 is one of these—the oscillator coil primary is in the cathode circuit! Feedback is through the two capacitors shown.

In other machines, a separate bias oscillator tube is used. It can be a simple tuned-plate oscillator as in Fig. 9-a or it may be a push-pull oscillator with transformer output, using twintriodes such as the 6CG7 or 12AU7, as in Fig. 9-b. The operating frequency is determined by the circuit constants.

In any case, these simple circuits should offer no problems to technicians who service hundreds of these oscillator circuits in TV sets. If they work, fine. Do they have enough output? If not, find out why, just as if you were working with a weak horizontal oscillator in a TV circuit. Changes in operating frequency, unless very drastic, should have

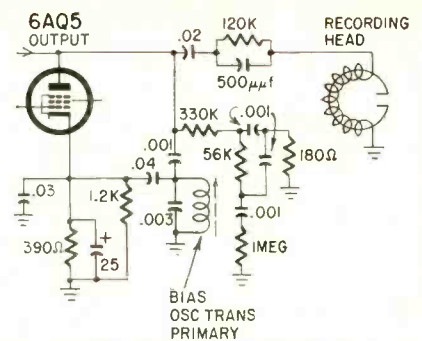

Fig. 7—Components in the 6AQ5 output circuit form an integrating network which changes the sine-wave signal into a series of pulses or spikes.

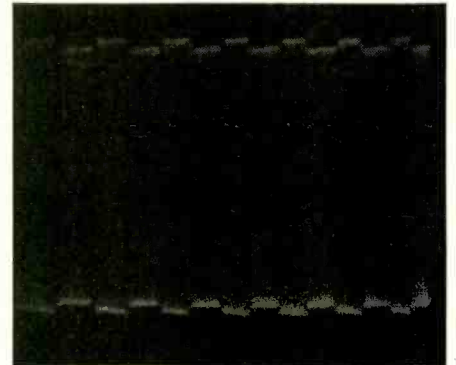

Fig. 8—Composite waveform, bias and signal, seen across recording head.

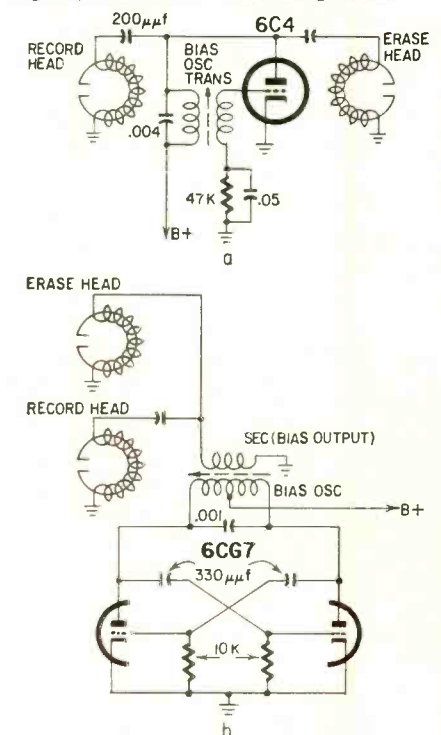
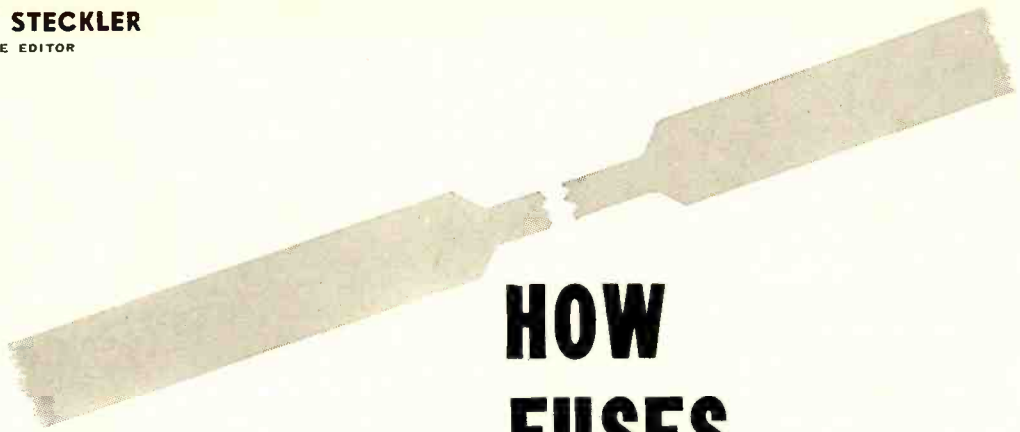

Fig. 9—Two bias oscillator circuits, commonly found in tape recorders.

little effect upon recorder operation.

Well, it looks as if we've gone about as far as we can go this trip. Next time we'll take up such fascinating subjects as recording-level indicators, switching (which makes up a very large part of recorder servicing), the recording head, testing, aligning and demagnetizing heads, together with as many mechanical features as we can. See you next month.

TO BE CONTINUED



# HOW FUSES WORK

*There's more to these tiny equipment savers than you realize*

**Q**UIETLY a screen capacitor shorts under continued stress. Current drain increases in the horizontal output tube. The flyback heats up. And a hair-thin filament inside a glass envelope melts away, restoring safety. This is what a fuse does!

Two leads in a line cord short. Sparks fly. Smoke starts to rise. And down in the basement a metal strip literally explodes. The current is cut off. That is what a fuse does!

The switch is thrown. Current is applied to a motor that doesn't start. The windings begin to heat up. Insulation starts to smoke. And a little pool of solder gets hot enough to melt, a spring lends its assistance. The circuit is

opened and safe. That is what a fuse does!

A 10-volt meter is connected to a 300-volt source. The meter pointer heads for the pin at the top of its range. And a microscopic filament gives way. The meter pointer drops back to zero. That is what a fuse does!

These are examples of the important thing a fuse does—protects electrical circuits. But *how* does a fuse protect? What kinds of fuses are in common use? How do they differ? Where do you use them? These are the questions we will try to answer.

Pick up a fuse, any fuse. No matter what its shape or size, somewhere on its body are two important pieces of information—a voltage rating and a current rating. Let's see just what these ratings represent. We'll take the current rating first.

This is always in amperes or a fraction of an ampere and can range from 1/500 ampere up to any desired value. It simply represents the amount of current the fuse will handle without opening. Greater currents will make the fuse open.

The voltage rating isn't quite so simple. It represents the maximum voltage that can safely be applied to the fuse. A fuse rated at 250 volts can be used in any circuit as long as no more than 250 volts are applied. If more than 250 volts are applied to a 250-volt fuse, several things can happen:

▶ If the voltage is much higher than the fuse rating, it may arc across the fuse.

▶ When a fuse blows, a section of the fusible element literally explodes. But if too high a voltage is applied, this explosive force is greater as a larger section of the fuse link is vaporized.

This can cause an under-voltage fuse to explode and send shattered case fragments into anything or anyone close by. The fuse is rated to withstand burnouts at its rated voltage, but will not stand up under excessive voltages.

▶ If a 250-volt 10-ampere fuse is used in a 250-volt circuit and the line shorts, the fuse blows. But no matter how much current goes through the fuse, it will not shatter when it blows.

## Types of fuses

With some variations there are three basic types of fuses—fast-acting, standard and delay. The fast-acting fuse is

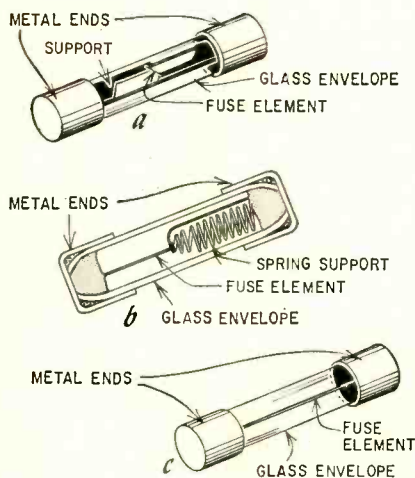

**Fig. 1—**a—Instrument fuse with anti-vibration mounting. b—Another type of anti-vibration mounting. c—Larger amperage fuses do not need anti-vibration mountings except in special applications.

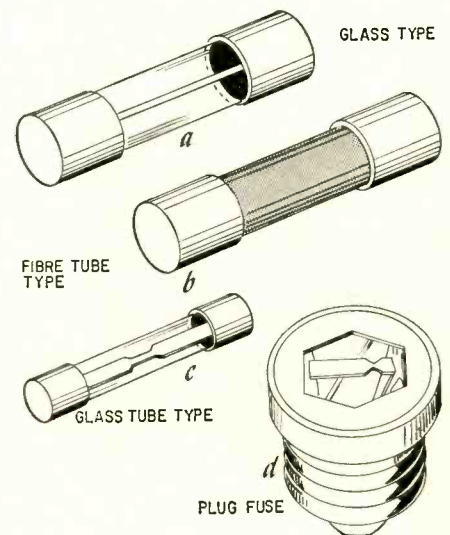

**Fig. 2—**Basic types of fuses: a—Cartridge type with glass envelope and wire fuse link. b—Cartridge type with fibre envelope. c—Cartridge type with ribbon element. d—Plug type with ribbon element.



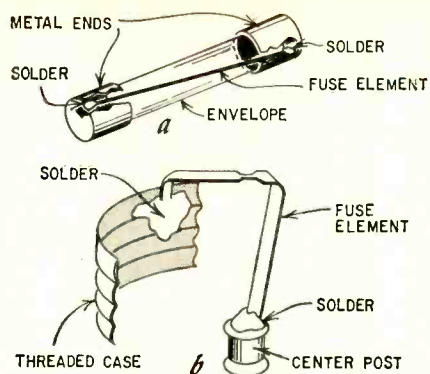

Fig. 3—Internal assembly of fuses. a—cartridge type; b—plug type.

designed to protect delicate meters and instruments. It is usually made only in values between 1/500 and 2 amperes. These fuses will carry their full rated current without opening, but a 200% overload will cause them to open in less than 5 seconds. Greater overloads will make them open even faster. For example, a 500% overload will open a fast-acting fuse in 3/100 second.

The smaller instrument fuses (1/500- to 1/32-ampere units) have extremely fine elements—some can barely be seen with the naked eye. Therefore they are supported bridge-fashion to protect them against vibration. Sudden shocks would snap such a fine element if it were not supported. The construction of this type of fuse is detailed in Fig. 1-a. In Fig. 1-b another type of anti-vibration mounting is shown. The 1/16- to 2-ampere sizes are illustrated in Fig. 1-c.

When we come to the standard types, we find a variety of sizes and shapes. Typical units are shown in Fig. 2. All of these are usually rated to carry 110% of their rated current without opening, yet will open in less than 1 hour if current goes up to 135% of the rated value. Again, greater overloads will blow the fuse much sooner, within fractions of a second in some instances.

The two major types of standard fuses are plug types (like those you use in your fuse box at home) and cartridge types that have either a glass, fiber or bakelite case. The elements are either a single wire or a flat ribbon (Fig. 2). In cartridge types this element is supported at each end (Fig. 3-a), while in plug types the mounting is a little more complicated (Fig. 3-b).

The amazing things about these fuses are the things not generally known. For example, let's take a plug type fuse that has just been subjected to a severe

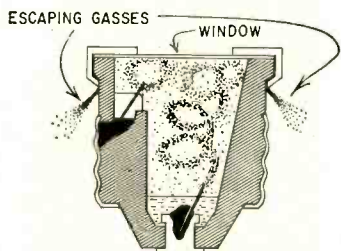

Fig. 4—When this type of plug fuse blows, gas escapes through vents around the cap.

overload. The intense heat caused by the excessive current turns the fuse link into white hot gases under tremendous pressure. Naturally, there must be a safe way for these gases to escape. One manufacturer handles this problem by making the top cap of its fuse act as a valve (Fig. 4). The hot gases spread out along the mica window in the top of the fuse and escape through tiny notches under the edge of the top cap. This cools the gases and allows them to discharge safely.

Now to one of the most interesting of all, the slow-blow or delay fuse. The thing that makes these units so fascinating is that they work in a variety of ways although they all do the same thing. Basically, a delay fuse will tolerate a certain amount of overload and do so intentionally. However, if the overload continues for an excessive period of time, the fuse opens. Also, a delay fuse will blow almost instantly if the overload is many times too great.

These fuses are often used where

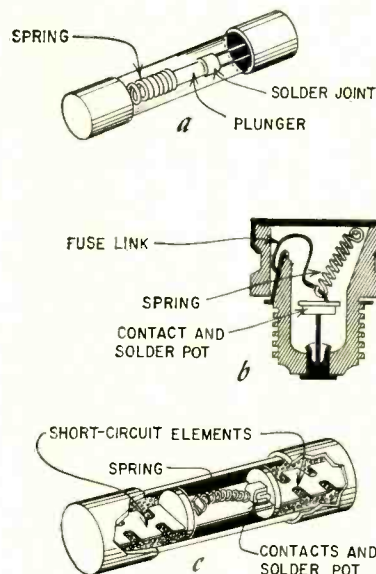

Fig. 5—Construction of various types of slow-blow and time-lag fuses.

motors (air conditioners, refrigerators, etc.) are in circuit, since such devices often draw starting currents several times greater than their running current. For example, a 7.5-ampere air conditioner needs a 15- to 20-ampere standard fuse to tolerate its tremendous starting current. But if the motor didn't start, it would draw enough current to burn out but not enough to open the fuse.

When you use a slow-blow fuse, however, a 10-ampere unit will take the starting surge of 15 to 20 amperes without blowing but, if this surge doesn't taper off within a reasonable time, the fuse will blow. This could happen if a starting capacitor shorted.

In some of the older TV receivers, slow-blow fuses were used to protect the high-voltage circuits. These sets developed transient pulses that would blow a standard fuse. By using a slow-blow fuse, however, the set manufacturer got a delay that was long enough to keep the fuse from blowing because

of transients, as well as protection against severe shorts. So in a TV receiver, never replace a slow-blow fuse with a standard type or you'll probably find yourself coming back again because of a blown fuse, even when there is no trouble in the circuit. Conversely, if you are having trouble with standard fuses blowing, don't substitute a slow-blow fuse. These will not protect the circuit properly and could result in a flyback burnout because a shorted damper tube didn't blow the fuse in time to save the flyback.

Now, we've seen where slow-blow fuses are used, and why. But just how do slow-blow fuses work?

Three kinds of slow-blow fuses are shown in Fig. 5. The first (Fig. 5-a) is a cartridge type. An overload heats up the solder that holds the contacts together. If the overload doesn't last too long, the solder cools and everything returns to normal. However, if the overload doesn't clear up, the solder melts and the spring pulls the contacts apart, opening the circuit. If there had been a short in the circuit, the fuse element would have vaporized—just as it would in standard fuses—before the solder even got a chance to warm up.

The fuses shown in Fig. 5-b and -c work in the same fashion; the only difference is in their design. Fig. 5-b shows a plug type fuse and Fig. 5-c is what is termed a time-lag fuse. Such a unit is designed to give a long time delay for special applications.

### Special types

Another group of interesting fuses are the indicating types. These units let you know when they have burned out or opened. In some (Fig. 6-a), a little plunger comes out the end, or the top (Fig. 6-b). Other devices can be added to these fuses so that, when they open, the plunger will close a switch to turn a pilot or warning lamp on or off. Or, as one manufacturer is doing, simple attachments may be added to almost any type of fuse, to light when the fuse blows. These units are shown in Fig. 6-c. Indicating fuses are most often found where a large number of fuses are mounted on a single panel. Here they become necessary if a blown fuse is to be found easily and quickly. Therefore, they are commonly used in industrial and military applications.

## FUSE IDENTIFICATION

### Cartridge Types

LITTELFUSE TYPE	BUSSMAN TYPE	DIMENSIONS (INCHES)	
		DIAMETER	LENGTH
1AG	AGA	1/4	5/8
3AG	AGC	1/4	1 1/4
3AB	ABC	1/4	1 1/4
4AG	AGS	9/32	1 1/4
4AB	ABS	9/32	1 1/4
5AG	AGU	13/32	1 1/2
7AG	AGW	1/4	7/8
8AG	AGX	1/4	1
9AG	AGY	1/4	1-7/16
SFE	SFE	1/4	Varies According to Amperage

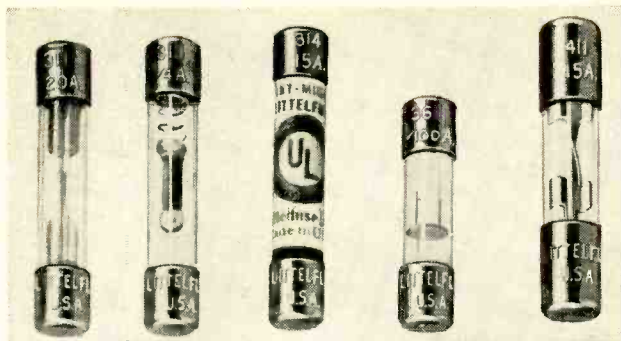

Five types of cartridge fuses made by Littelfuse.

momentarily, the short surge starts to heat up the wire in the fuse but doesn't last long enough to have any effect. (This same transient would burn out a standard ¼-amp fuse.) However, if there is a short that exceeds the current rating of the fuse and lasts longer than a few instants, the wire in the fuse gets hot enough to set off the chemical coating and the fuse element disintegrates. (This action is much faster than that of a slow-blow fuse and therefore provides greater protection.)

### Fuse identification

There are two major manufacturers of fuses in the US today—Littelfuse and Bussmann. These companies use different codes to identify their fuses. For the technician who may run into a Littelfuse and has only Bussmann replacements, or the man who runs into a Bussmann fuse and has only Littelfuse replacements, we have listed both makes in a table that shows equivalent units.

When replacing fuses, an important factor is physical size. In automotive fuses, for example, only one amperage fuse will fit in a particular fuse holder since each amperage fuse is a different length—the higher the current rating, the longer the fuse. However, for other applications, many fuses will all have the same length. For example, in the 3AG series, all fuses are the same length, no matter what current rating they have. Also, the 20-amp auto fuse is the same length as all the 3AG fuses.

Therefore, when replacing fuses, always be sure that you are using a replacement whose voltage and current ratings are identical to those of the fuse that blew. And remember, if a fuse keeps blowing, something is drawing too much current—don't replace the blown fuse with one that has a higher current rating. It may not blow, but your wiring may overheat and start a fire. Or in a TV receiver you'll lose a \$10 flyback transformer instead of a 25-cent fuse.

So where do we use the many types of fuses we have surveyed? Quick-acting units go into that expensive voltmeter or other delicate test instrument that small overloads may damage. The slow-blow types go wherever short surge currents are normal and where a standard fuse would blow, even though there is no fault in the circuit. And standard fuses are used about everywhere else.

But to play it safe, whenever you replace a fuse, use one that has identical ratings to the one that blew and you can't go wrong. You can track down a dead short with an ohmmeter; a slight overload will call for checking the parts that draw current off the line by removing them one at a time. When the current drops to normal upon removing a particular part, you know that it is the defective one. So don't take that little glass tube or screw-in device for granted. Use it properly and it can be a lifesaver.

Thanks to Bussmann Manufacturing Div., Littelfuse Inc., and the Sight-master Corp., for supplying much information. END

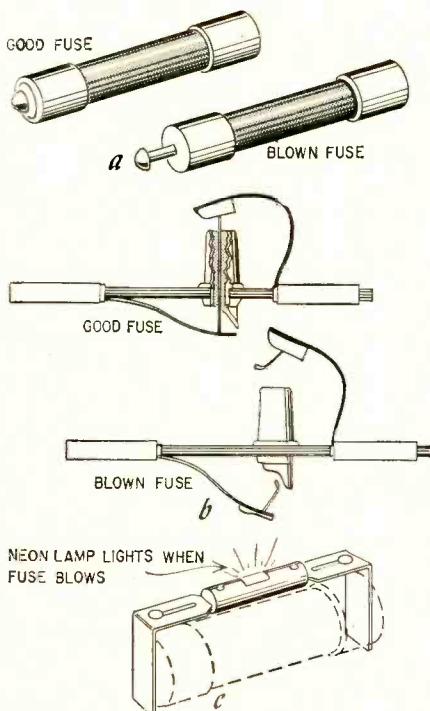
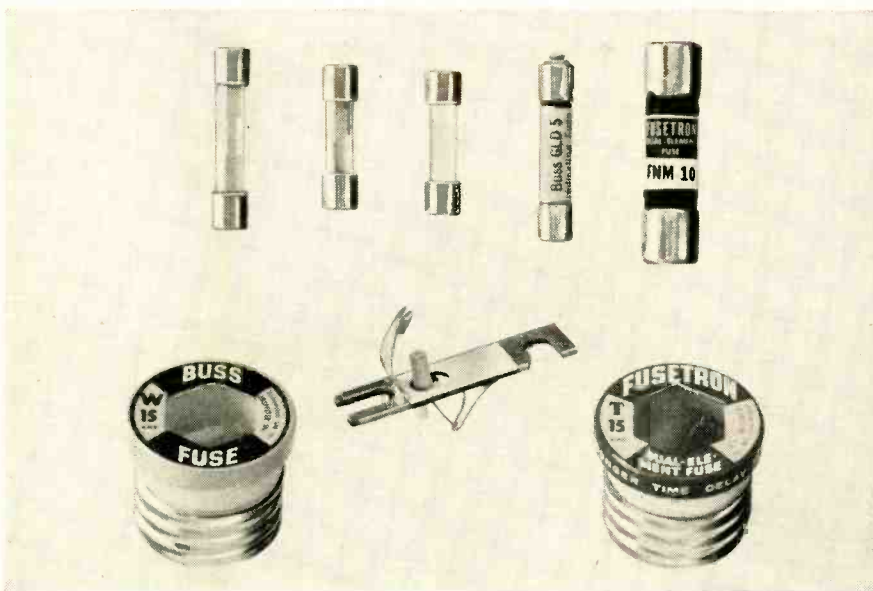

Fig. 6—Special types of fuses: a—Pin comes out end of indicating fuse when it blows. b—Grasshopper fuse springs apart, gives positive action. c—Another type of indicating fuse.

Still another special type fuse is the grasshopper. It has already been shown in Fig. 6-b where its application as an indicating fuse was shown. But even more important is its action when it blows. The two leaflike elements spring apart, giving a quick-acting fuse that is practical for high voltages. The spring action pulls the broken ends of the fuse so far apart that no arcing can occur across the gap.

Another type of fuse is the fusible resistor found in many recent-model TV receivers. This unit is a wirewound resistor with some specific ohmage rating—somewhere between 5 and 13 ohms. It provides two types of protection. It acts as a series resistance that protects rectifiers in the set against sudden voltage surges, and it acts as a slow-blow fuse for overloads. The unit is actually a wirewound resistor, but one that will burn out if the set draws excessive current.

A rather different type fuse is the chemical fuse. To date it is used by only one manufacturer (RCA), to protect the B-plus circuit of TV receivers. It looks like a standard cartridge fuse in size and shape, but instead of a glass cylinder surrounding the fuse element, there is a ceramic jacket. The fuse element itself is a metal wire covered with a special chemical coating. When it is in the B-plus circuit of a TV receiver, it passes current just like any other fuse. If the damper cathode arcs over



Bussmann makes this assortment of fuses.

Table-top instrument gives you a continuous check on CB transmitter operation

# Modulation monitor checks CB transmitters

By LYMAN E. GREENLEE

HERE is an essential piece of test equipment for anyone planning to work with Citizens band transceivers.

This is what it is:

- ▶ A dummy antenna that loads the transmitter for off-the-air testing.
- ▶ A tuning indicator, with resonance shown by electric eye, milliammeter and pilot bulb.
- ▶ A modulation monitor, with provision for listening to the transmitter output through headphones.
- ▶ A modulation percentage indicator.

- R1—pot, 20 ohms, 3-5 watts, wirewound
- R2—1,000 ohms, 1 watt
- R3—pot, 1 megohm, linear taper; screwdriver adjust
- R4—16,000 ohms, 1 watt, 1%
- R5, R6—1 megohm, 1/2 watt
- R7—3,300 ohms, 1/2 watt
- R8—470,000 ohms, 1 watt
- R9—10,000 ohms, 2 watts
- R10—270 ohms, 1 watt
- R11—100 ohms, 1 watt
- C1—4-30  $\mu$ mf, ceramic trimmer
- C2, C4—.001  $\mu$ f, mica
- C3—12  $\mu$ mf, ceramic
- C5—470  $\mu$ mf, mica
- C6, C7—.05  $\mu$ f, paper, 200 volts
- C8, C9—10  $\mu$ f, 450 volts, electrolytic
- C10—330  $\mu$ mf, mica or ceramic
- D1, D2—1N75

J1—phone jack, open circuit (Switchcraft type 11 or equivalent)

J2—phone jack, closed circuit (Switchcraft type 12A or equivalent)

L1, L2—rf transformer; coils cut from B&W Mini-ductor. Use one type 3011 and one type 3015 cut as described in text

PILOT 1—indicator light assembly with No. 40 bulb (Dialco M-432, Series 810 or equivalent)

PILOT 2—indicator light assembly with No. 40 bulb (Dialco type 504 socket or equivalent)

PL—Phono plug or other connector to match transmitter.

RECT 1, RECT 2—selenium, 130 volts, 50—65 ma

RFC—21  $\mu$ h (Ohmite Z-28 or equivalent)

S1—sps toggle switch

S2, S3—dpdt toggle switches

T1—power transformer; primary, 117 volts; secondary 250 volts, 25 ma. ct.; 6.3 volts, 1 amp (Allied Radio 62 G 008 or equivalent)

T2—audio transformer; 1:1 ratio (Philco 32-7484, Stancor A-4711, Thordarson 20A29 or other Small 1:1 transformer)

V—6AL7

Tuning-eye assembly for V (Amphenol 58-MEA-8)

Terminal strips, 6 lug (5)

Terminal strip, 3 lugs (1)

Grommets, 1/2 inch (2)

Grommets, 3/8 inch (4)

Grommets, 1/4 inch (3)

Length of 72-ohm line (3 feet)

Case, 6 1/2 x 9 1/16 x 7 5/16 inches with sloping front (Bud C1585 or equivalent)

Chassis, 7 x 7 x 2 inches

Miscellaneous hardware

- ▶ An rf output indicator.
- ▶ An af output indicator.
- ▶ A carrier-shift indicator.
- ▶ A convenient means for coupling an oscilloscope to a transmitter.

Good clean speech is rare on the Citizens band. Blasting, distortion, phase shift, hum and poor frequency response are common difficulties with transceiver transmitters. Unless the operator has some way of monitoring his own transmissions, he may never know how bad he sounds on the air, and will continue to blast away with a scarcely readable signal. Modulation troubles may be within the transceiver or be caused by ignorance of proper mike technique, use of a microphone with poor frequency response, a defective installation, antenna or power supply. Regardless of where the trouble may be or what is causing it, there is no easy way to locate the difficulty without monitoring the transmitter signal.

All Citizens-band transmitters should be checked out off the air. The trans-

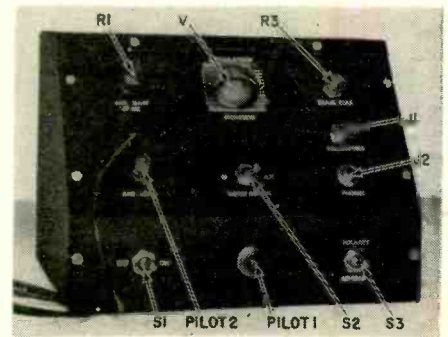

The finished instrument in its crinkle-finish case.

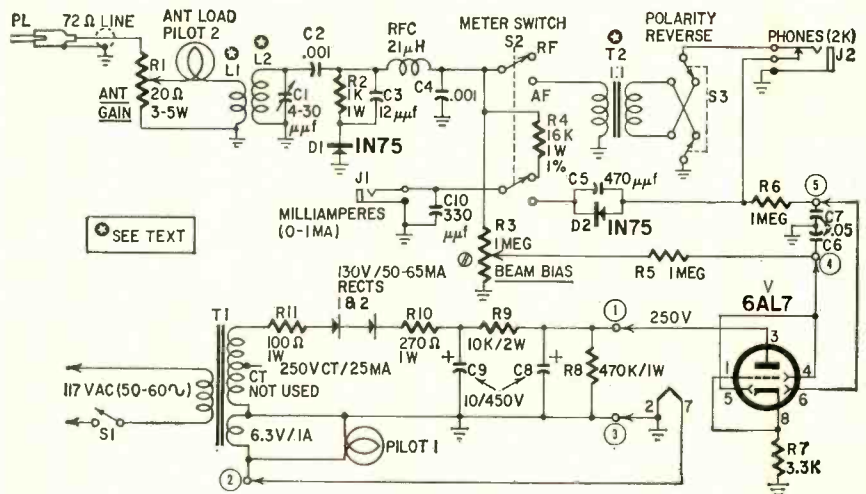
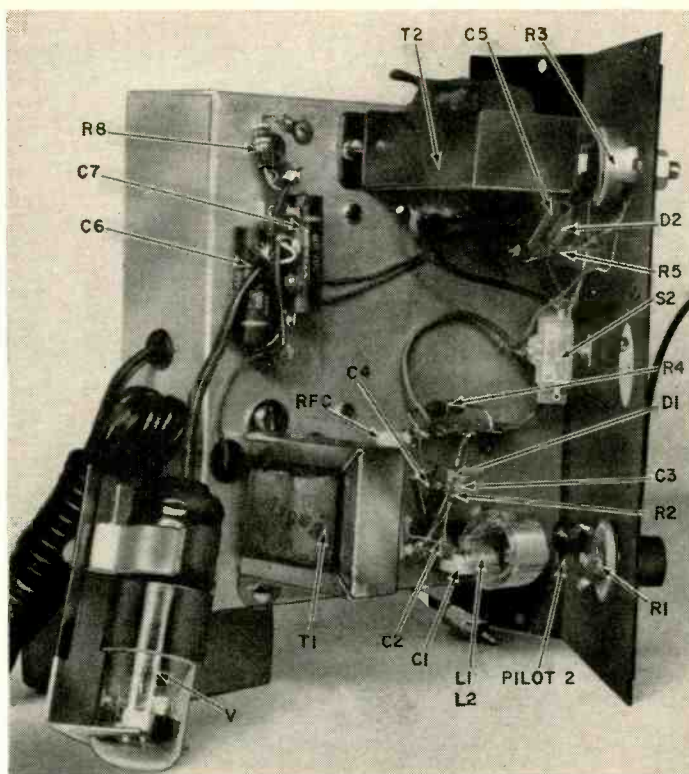
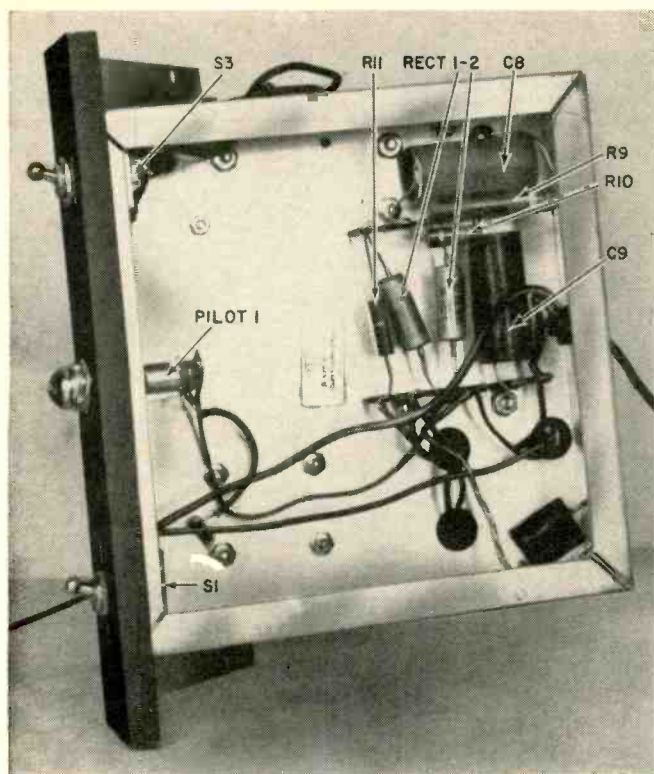

Fig. 1—Circuit of the modulation monitor.



Most underchassis parts are mounted on terminal strips.

Top chassis view shows parts arrangement.

mitter must work into a dummy antenna to be properly loaded and prevent interference from being radiated to other stations. A pilot light is the usual dummy-antenna load resistance. The modulation monitor combines the pilot light with a modulation indicator and tuning meter.

The transceiver under test is coupled to the monitor through a length of 72-ohm line. The rf signal feeds directly from the transmitter through an attenuator to drive a diode detector whose output is used to indicate either rf or af output on any milliammeter (which may be a part of other test equipment).

To check percentage of modulation, the signal is fed through a 1-to-1 ratio

transformer to remove the unmodulated rf, and the af component is again rectified to separate the positive and negative signal peaks. Both af and rf signal levels can be measured on the same meter by flipping S2 (Fig. 1), and the af meter reading will be in percentage of modulation when the input is adjusted so the rf reading is exactly 1 ma. S3 is a polarity reversing switch for checking relative values of upward and downward modulation peaks. The 6AL7 tuning eye is a double-target tube designed primarily for FM tuners. The two separate targets are coupled to the rf and af outputs so both may be simultaneously monitored on the tuning-eye screen.

### How you build it

The monitor is assembled on a 7 x 2-inch aluminum chassis, fitted in a metal cabinet with sloping front. The panel layout and chassis hole location are shown in Figs. 2 and 3. If parts substitutions are made, arrange the parts on the chassis and outline them in pencil as a guide for drilling the mounting holes. While parts layout is not critical, the af transformer and wiring must be kept well away from all components and wiring carrying rf. The front panel is not fastened to the chassis until all parts are mounted and most of the wiring has been finished.

Assemble and wire the power supply under the chassis first. An isolation

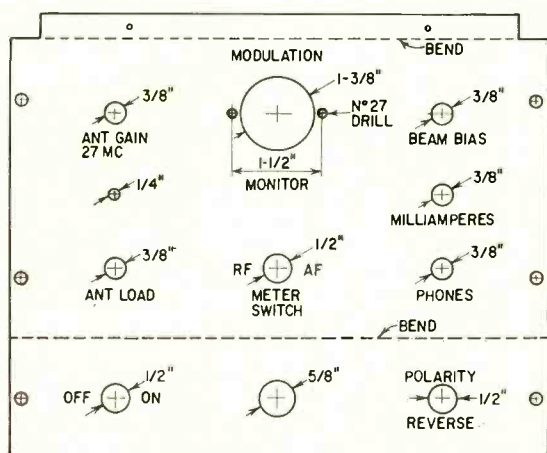

(FOR CABINET BUD C1585, OR EQUIV, 9-1/16" X 6-1/2" X 7-5/16")

Fig. 2—Front panel layout for slope front cabinet.

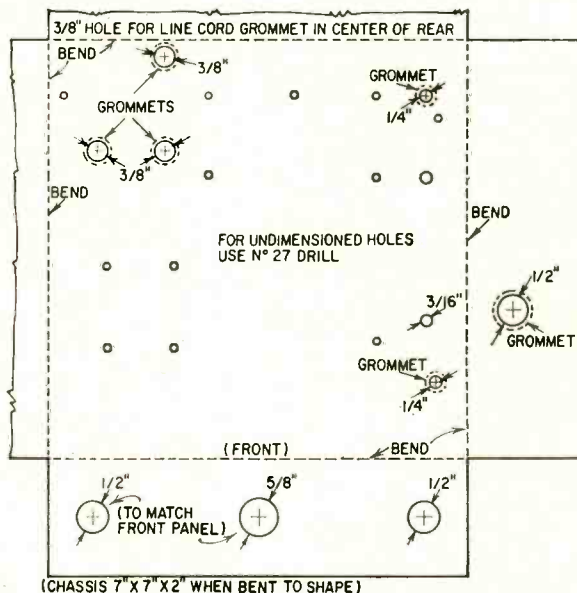

(CHASSIS 7" X 7" X 2" WHEN BENT TO SHAPE)

Fig. 3—Chassis layout for the modulation monitor

transformer and selenium rectifiers furnish the 250 volts dc for the tuning eye, and also the 6.3 volts for the 6AL7 filament and the pilot light. Leads from the power transformer are pulled through the three holes insulated with 3/8-inch rubber grommets. The rectifiers, resistors and capacitors are supported on two six-lug terminal strips. (If the selenium rectifiers are the bolt-mounting type, stack and fasten them to the chassis with a single bolt.) Resistors R10 and R11 protect against voltage surges and act as fuses if the selenium rectifiers should ever short. If the plate voltage on the 6AL7 exceeds 250 after tube warmup, decrease the value of R8 and, if necessary, increase R9 to 15,000 ohms.

Disassemble the Amphenol socket and cover for the 6AL7 tuning eye, and check the connections. Modify the wiring to conform to Fig. 1. Wire the tuning-eye assembly along with the rest of the chassis, but do not install it on the front panel until all other assembly and wiring is finished. Since the front panel is held to the chassis by the pilot light and switches S1 and S2, temporarily fasten these parts to the front of the chassis until you are ready to attach the front panel.

Transformer T2 may be any small 1-to-1 ratio audio transformer or isolation transformer. A 2-to-1 ratio push-pull audio driver can be used if half the winding is used to get the required 1-to-1 ratio. Pull two leads from S3 up through the 1/4-inch grommet in the top of the chassis and allow enough length to reach J2 after the front panel is installed. T2's secondary leads are dressed through the 1/2-inch rubber grommet on the side of the chassis and pulled up to S3. Allow enough slack on these leads to permit moving S3 while the front panel is being fastened in place.

Tuning coil L2 is 10 turns cut from a B & W Miniductor form, type 3015, and L1 is 3 turns cut from a type 3011 form. Slip the 3-turn antenna section inside the larger coil and fasten it in place with a few drops of polystyrene cement. As shown in the photographs, L2 and the other components of the rf portion of the monitor are supported from the chassis on a pair of 6-lug terminal strips. A 4-30- $\mu$ mf ceramic padder tunes L2 to the 27-mc band. Tuning is not critical and the padder may be set for the middle of the 27-mc band and left alone.

Wire the components on the front panel before attaching it to the chassis, and leave leads long enough to reach chassis components. Connect the 3-foot length of 72-ohm line directly across the 20-ohm potentiometer. Run a short length of wire from the center tap of the potentiometer to the No. 40 pilot-lamp socket and attach a length of wire from the ground side of the 72-ohm line to the base of coil L1. Note that in wiring the rf section, all ground connections are made to a common point—the base of L1—and all leads carrying rf are kept as short as possible and completely away from the af portion of the circuit.

A phono plug is shown as the antenna connector in Fig. 1 since many Citizens-band transceivers use this type of connector. Of course, if your set has a different type connector, use a plug to match the antenna jack on the transceiver. If there is any indication of body capacitance effects when adjusting R1, run a separate ground wire from the chassis of the monitor to the chassis of the transceiver.

Fasten panel and chassis together after completing the wiring on both. Connect the remaining leads between them, install the tuning eye, and the job is finished and ready for testing. For a preliminary check, plug in the line cord, measure the 6AL7 plate voltage (change resistors if above 250 volts) and observe the pattern on the 6AL7 screen. If a grid-dip meter is handy, set it to the 27-mc band and couple closely to L1. Adjust padder C1 for resonance, and adjust R5 to deflect the tuning-eye beam. Now plug the 72-ohm line into a transceiver antenna jack. Set R1 at about half-scale. Set S2 to RF. Plug an 0-1-ma meter into J1. It will be convenient to make a set of test leads for this purpose out of a phone plug, length of lamp cord and a couple of plugs that will fit the pin jacks on the meter to be used. With the milliammeter connected (observe correct polarity) and the transceiver set to transmit, the meter should read slightly less than full scale. Adjust padder C1 for maximum reading; then adjust R1 until the meter reads full scale on rf. Now flip S2 to AF. The meter reading should drop to almost zero, but should rise sharply when you speak into the microphone. If the RF reading was carefully set at exactly 1 ma (full scale), the meter reading in the AF position will be directly in percentage of modulation—a full-scale reading of 1 ma being equal to 100% modulation.

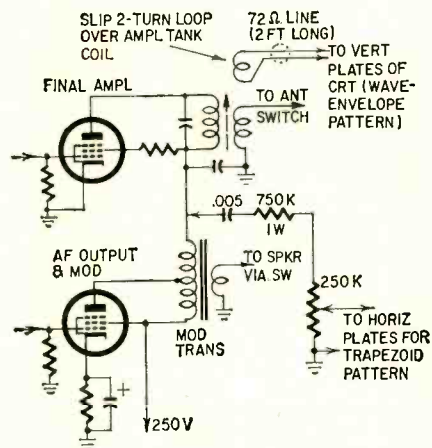

Fig. 4—Calibrate monitor with a scope by comparing scope patterns with monitor readings.

Now plug a pair of 2,000-ohm headphones into J2 and you can monitor speech from the transceiver. Since it is difficult to judge the quality of one's own voice, have someone else talk into the mike while you listen to the quality, or connect a tape recorder to the phone jack and record your voice from the transceiver. Listen to the recording and try to correct errors in mike technique.

For a correct meter reading on AF, the headphones must be removed. One side of the 6AL7 pattern will indicate audio modulation and flicker as you talk into the mike. Adjust R3 so the other side of the pattern is almost closed when the meter reads full scale on RF. Due to the load of R1 across the 72-ohm line, the No. 40 pilot bulb in the antenna circuit will not glow as brightly as it would if used alone as a dummy antenna. With R1 at maximum, the bulb should light with about half the brilliance obtained with a direct connection to the transceiver antenna jack.

If the transmitter output is pure unmodulated rf, there should be no sound in the phones and no AF reading on the meter. There will usually be a small amount of signal caused by hum and random noise in the carrier. By listening to the output, this residual reading can be identified as either noise or hum and corrective measures can be tried if it is excessive. Check with the mike removed and mike input terminals shorted.

If an oscilloscope is available, you can calibrate the modulation monitor. Connect the scope as shown in Fig. 4 to get a modulation pattern from the transmitter.\* Feed an audio signal, preferably from an audio generator, into the transmitter mike input and set

\*For a more complete discussion on using the oscilloscope to check AM phone operation, see the current issue of *The Radio Amateur's Handbook*, published by the ARRL.

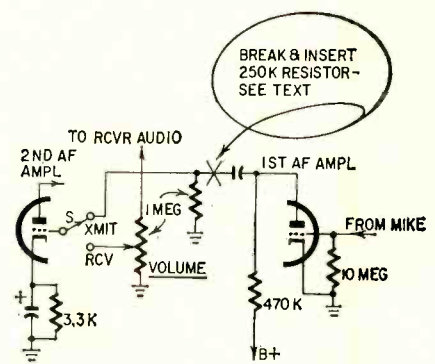

Fig. 5—How to cut gain to reduce modulation, if necessary.

the level for 100% modulation as observed on the scope. With the meter set to read full scale on rf, the af component should also read full scale. If the af component of the modulated signal does not read the same as the rf component, change R4 to a value that will give the correct reading. By adjusting R1 to reduce the gain, the meter can be made to read half-scale on RF, and this half-scale reading should be compared to the reading on AF with 100% modulation as a further check of accuracy before making any change in R4. Both readings should be the same for 100% modulation.

The scope's vertical amplifier can be connected to the monitor in place of the phones to display voice patterns from the transmitter. Any audio signal fed into the mike input of the transceiver will appear as a corresponding pattern on the scope screen and can be used as a basis for making an overall check of the frequency response of the transmitter, limited of course to any distortion that may be introduced by T2. By running checks on transceiver transmitters known to be good, the operator can learn the type of pattern to be expected on the screen, and the amount of distortion introduced by T2 and the scope's vertical amplifier.

S3 is a polarity-reversing switch that enables observation and checking of both positive and negative modulation peaks. Under ideal conditions, reversing the polarity with S3 would make no difference in meter reading (AF). However, under normal modulation conditions the positive and negative peaks will not be exactly equal and there will be a slight difference in the meter reading. Any substantial difference in meter reading when the polarity is reversed indicates some defect in transmitter modulation. There is probably a shorted turn in one winding of the modulation transformer.

With S1 in the RF position, a fluctuating meter reading when the transmitter is being modulated indicates carrier shift that is usually caused by a nonlinear distorted modulation amplifier. Under normal modulation, the carrier reading (RF) should remain steady for a modulated signal. At modulation levels approaching 100%, there will be some carrier shift in most transceivers. Modulation level should be set at a level that never exceeds 95%. If the modulation is over 100%, usually all that is necessary is to reduce the gain in the speech amplifier to a level that allows a maximum of 95% modulation. Because of the varying sensitivity of different microphones, it is easy for a change of microphones on a transceiver to alter the modulation level and force it over the 100% point. A 250,000-ohm resistor in series with the coupling capacitor to the grid of the second audio stage in the speech amplifier is usually all that is needed to cut the gain to an acceptable level (Fig. 5). The added resistor may be any value necessary to reduce the level to the point where there is no blasting or overloading. Try values between 50,000 and 250,000 ohms. END

# WHAT'S YOUR EQ?

We are starting this month a department of mental calisthenics—an opportunity for you to see just how fast your brain can turn corners. So that everybody can have a chance, the exercises are graded into three groups. The first will be practically on the engineering level, the second something for the good practising TV technician and the third for the beginner.

Next month we will publish possible solutions to the first two questions, plus the answer to the third.

Since the first two problems will probably have more than one good solution—there are more ways than one to lick a design problem, and a single set of symptoms in a TV set may have more than one cause—we are asking our readers to send in what they consider the best solutions for the first two. Mail your answer to Puzzle Editor, RADIO-ELECTRONICS, 154 W. 14th St., New York 11, N.Y.

RADIO-ELECTRONICS invites its readers to send in their own original brain-teasers. We will pay \$10 for each one used.

## Photo-relay circuit

TWO photo-relay circuits are to be used to maintain the temperature of an oven between the limits of 450° and 500°. The phototubes are illuminated through two openings in the temperature-indicating meter of the oven as shown in the drawing. The oven is heated by a 117-volt heating element which should turn off when the meter pointer blocks the opening at 500°, and turn on again when the pointer drops back to 450°. The 50° dead zone is used to limit the number of relay operations per hour (which would be much higher in a single phototube system). What circuit arrangement will provide the desired temperature regulation without

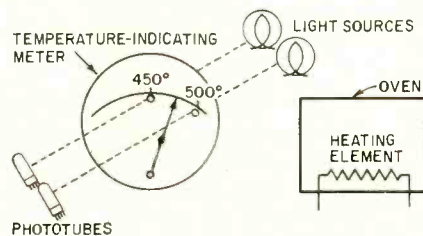

requiring any manual controls except an on-off switch in the power line? The circuit must work from a "cold" start when the pointer of the meter is still below the 450° level.—Ed Bukstein

## Service Stinker No. 1

**S**YMPOMS: No picture. Slight hum in sound. Resistor R1 burns out immediately. ½-watt size is correct; other sets work with this value. Dc voltages normal. No shorts to ground. Tubes all replaced.

**QUESTION:** What is burning R1 out in such a hurry?—Jack Darr

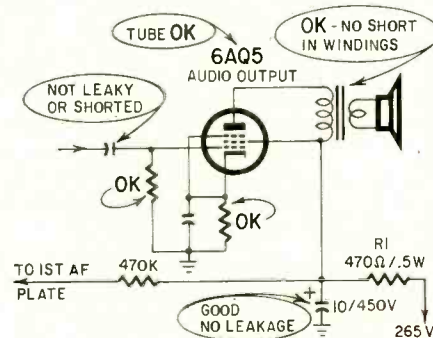

## Black Box

**T**HIS is one of the classics among the simple problems. It requires knowledge of only the most fundamental laws, and can have but one answer. Yet it is very tricky for the person who is not looking for that one answer.

A black box is connected to a power source that supplies it with 10 volts and 1 ampere, as indicated by a conventional voltmeter and ammeter. Yet an

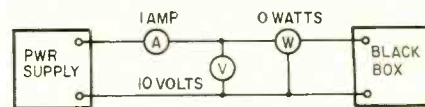

equally conventional wattmeter also connected across the input of the black box shows that no power is being supplied to the load. What is in the black box? END

# COMMUNICATIONS

## ON 450,000,000 MC

The optical maser is a source of coherent, monochromatic light. By modulating and amplifying this coherent light emission, it will be possible to use light as radio waves are used today. Until now, there were coherent sources of electromagnetic waves only for frequencies less than  $10^5$  mc ( $10^{11}$  cycles) (Fig. 2). The optical maser has raised this limit almost 10,000 times. And not only has the frequency been increased but the sharpness—or fractional bandwidth—has also been improved.

COVER  
STORY

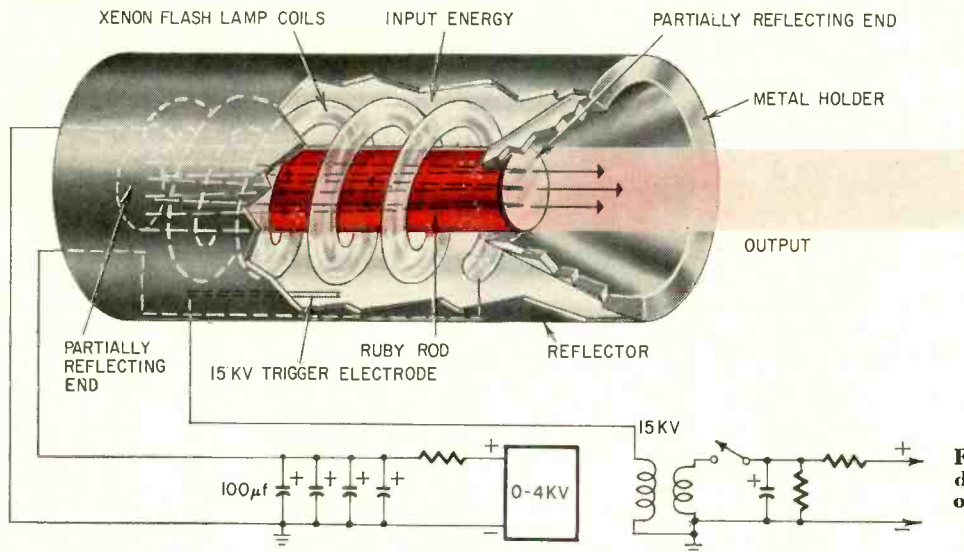

Fig. 1—Basic diagram of the optical maser.

By R. J. COLLINS  
and D. F. NELSON

MASER STANDS FOR MICROWAVE AMPLIFICATION by stimulated emission of radiation. Following the proposal by Prof. C. H. Townes of Columbia University and Dr. A. L. Schalow of Bell Telephone Laboratories to extend the maser principle from the microwave region to the optical spectral region, some people have used the acronym *laser*, the letter *l* standing for light. But since the principles are the same in both cases, the tendency simply to say "optical maser" is growing.

The ruby optical maser as reported by Bell Telephone Laboratories and similar to the Hughes Research Group's development consists of a Linde synthetic pink ruby rod 0.20 inch in diameter and 2 inches long. Both ends of the rod are optically polished to make them flat within  $2 \times 10^{-6}$  inches and parallel to within 10 seconds of arc. The end surfaces are made partially reflective, allowing only about 5% of the light striking them to pass through.

A source of input power, a xenon-filled flash lamp, surrounds the ruby rod. It is pulsed by discharging a bank of capacitors through it. Charged to

4,000 volts, the bank delivers 3,000 joules to the lamp in about 1 millisecond.

Fig. 1 shows both the mechanical and electrical details of the construction of a pulsed-ruby optical maser. In the bottom section is a 0-4,000-volt power supply, used to charge the bank of four 100- $\mu$ f 4,000-volt capacitors. The series resistor limits the charging current. Also shown is the supply for the 15-kv transient that triggers the FT524 flash tube.

A funnel-shaped cone holds the ruby rod axially within the helical coil of the flash tube. Surrounding the entire

assembly of holder and lamp is a reflector. It can be either highly polished aluminum sheet or powdered magnesium oxide. It contains the flash-lamp output so a large fraction of it will be absorbed by the ruby. The output of the flash lamp is white light but only the green and violet portions of it can be absorbed by the ruby.

Besides the essential parts—ruby, flash lamp and reflector—a coolant for the ruby and flash tube, and opaque shields surrounding the exterior parts complete the maser.

### Atoms and radiation

Why a maser—optical or microwave—operates can be understood with the help of Fig. 3. This drawing shows the interaction of an atomic system and radiation. Fundamentally, the only difference between microwave masers and the new optical ones is the spacing between the energy levels. In the microwave maser, these levels are separated only 1/10,000 as far as in the optical maser.

All atomic and molecular systems have their electrons in such discrete and separate energy levels. "Discrete and separate" means that only certain amounts of energy can be stored by the electron in atoms or molecules. An electron can increase its energy by absorbing, from an electromagnetic wave striking it, an amount of energy just equal to the difference between two levels. Conversely, it can decrease its energy by emitting a photon—a pulse of electromagnetic radiation equal in energy to the spacing between two levels. The frequency of the radiation emitted in such processes is proportional to the energy.

Normally, in an atomic system, the electron is in the lowest energy level or ground state. If an electromagnetic wave (photon) strikes the system (Fig. 3-a), the electron absorbs the photon energy. But if the system has been prepared (by applying energy from some outside source) with more electrons in excited states than in the ground state, a wave would not cause absorption, but rather would cause the *emission of radiation*. This process is called *stimulated emission* (Fig. 3-c) to distinguish it from spontaneous emission.

Spontaneous emission is the kind that occurs when the excited electron emits energy and decays to the ground state without the help of an incident wave (Fig. 3-b). Spontaneous emission is important in a maser since it is the dominant loss mechanism. That is, the input power must be greater than the stimulated emission before maser action can occur. For maser operation, a system is prepared so that more electrons are in an excited state than in the lower state. A light wave passing through the atom then stimulates emission and thus is amplified. (When a system has more electrons in an upper excitation state than in a lower state, it is said to have an *inverted population*.)

Ruby, which is crystalline aluminum oxide ( $Al_2O_3$ ), with chromium atoms

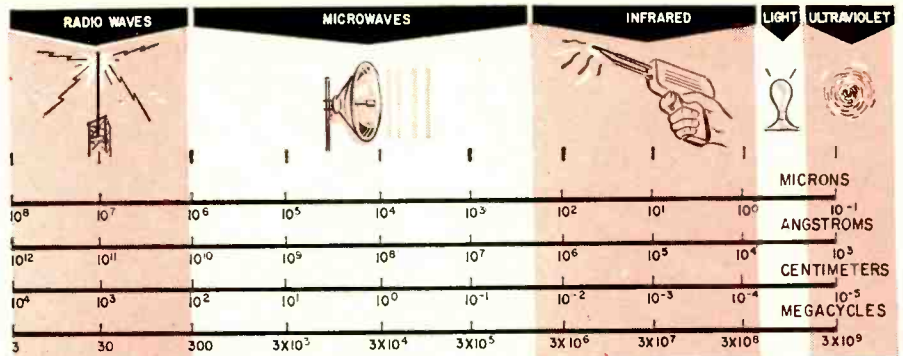

Fig. 2—Frequency spectrum shows relationship of electromagnetic waves.

substituted for some of the aluminum atoms, has a set of energy levels well suited for use as an optical maser. This particular set of levels is for an electron attached to the chromium ion ( $Cr^{+++}$ ). It is the absorption of green and violet light by these ions that gives ruby its familiar red color.

Fig. 4 shows the steps whereby the absorption of green and violet light can be used to create an inverted population. Electrons, excited by the absorption of green or violet light, are driven from the ground state to the higher excited states shown in the figure as solid rectangles. From these highly excited levels the electrons fall rapidly to the lowest excited energy state giving some energy to the crystal lattice in the process. This lowest excited state has a long lifetime for spontaneous decay (about 3 milliseconds) and is therefore called *metastable* (comparatively stable). From the metastable level, the electron drops to the ground state, radiating energy as red (6943Å) light.

A large number of the  $Cr^{+++}$  ions in ruby can have ions in the metastable level when a strong green light shines on the crystal. If electrons arrive in the metastable state faster than they return to the ground state, the electron population will become inverted. The xenon flash lamp is an intense enough source of green and violet light that more than half of the  $Cr^{+++}$  ions have their electrons in the metastable level for short periods of time.

When the  $Cr^{+++}$  ions are in an "inverted-population" state, red light passing through the ruby will stimulate emission and thus be amplified. To make an oscillator, the flat ends of the ruby rod can be made partially reflecting, allowing some light to be fed back and further amplified.

Let us now examine in detail the operation of the oscillator. After the inversion is accomplished through the excitation provided by the green light, the excited electrons begin to return to the ground state by emitting red light. Most of this light, being emitted as spontaneous emission, will be lost, since it is emitted in all directions, and any light striking the sides will leave the crystal.

A small part will be emitted along the axis of the ruby cylinder. This small part, while traveling down the crystal, will stimulate more radiation by interaction with the excited electrons in the  $Cr^{+++}$  ions. The stimulated emission is

directed along the axis of the cylinder. With growing intensity, the light wave moves down the ruby crystal and finally strikes the reflecting end. These ends allow approximately 5% of the light to escape from the crystal. The other 95% is reflected to make another pass through the crystal. On this, as well as along succeeding passes, it will stimulate emission and be amplified. In this sense, the process is analogous to a regenerative radio-frequency circuit, where part of the energy is fed back to produce still more energy. The red-light output of a ruby maser is an electromagnetic wave at  $4.3 \times 10^6$  mc.

As a result of passing the light back and forth between the end plates in the oscillator, standing waves of the light are set up the crystal. The emission stimulated by this standing wave will then have the same phase across any section of the rod, including the partially reflecting end plates. It will be *coherent* across the end faces. Since the radiation transmitted through the ends (the 5% not reflected) consists of a single phase, directional beams are possible.

Normal radio or radar antennas may be several hundred wavelengths wide and have beam widths of several degrees. The optical maser is about 10,000 wavelengths across and has a beam width of .01°. This property of coherence, therefore, makes possible a very directional beam.

The extremely narrow cone of emission is remarkable particularly when compared to a normal light source. The radiation from all other light sources is emitted uniformly in all directions (even in the maser rod itself the spontaneous portion of the emission is so radiated) while only the maser emission is confined to the narrow cone. Some idea of the cone width can be obtained from the experimental results obtained by the Bell Telephone Laboratories group. They observed that light from the maser covered a circle about 200 feet in diameter at a distance of 23 miles.

The frequency bandwidth of an optical maser is much narrower than the bandwidth of the spontaneous radiation from the same material. At room temperature (300° Kelvin) the spontaneous decay of electrons from the metastable level (Fig. 4) in ruby to the ground gives an emission with a width between the half-power points of 3Å.



INTERACTION OF PHOTONS (LIGHT) WITH ELECTRONS IN DISCRETE ENERGY LEVELS

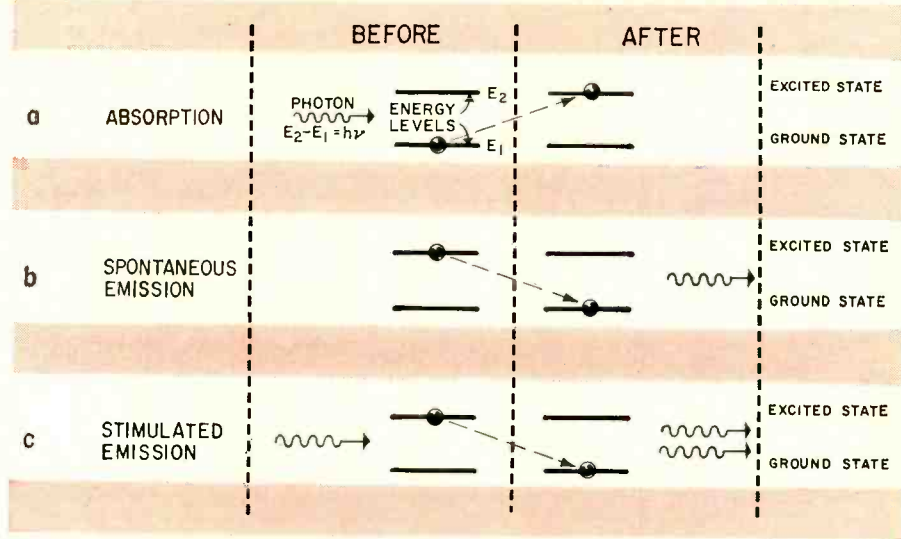

Fig. 3—Interaction of an atomic system and radiation: a—Absorption; b—spontaneous emission; c—stimulated emission.

or  $1.8 \times 10^5$  mc. When maser action begins and the decay is dominated by stimulated emission, the width decreases by a factor of 100. This decrease in line width results from the feedback employed in the maser. The analogous situation in electronic circuitry—where positive feedback may be used to sharpen selectivity in a communications receiver, or unwanted regeneration may ruin the response of a television or FM if stage—is well known.

The pulsed ruby maser is the most powerful monochromatic light source now available. In a bandwidth of  $6 \times 10^2$  mc, ruby optical masers generate about 1 kw. By comparison, the standard high-purity light sources available in the past, such as the mercury arc, would emit only fractions of a watt in a comparable bandwidth. Furthermore, in such sources the energy was emitted nearly uniformly in all directions—the

optical maser light is confined to a narrow cone.

A good way of thinking about the brightness of a radiation source is in terms of its temperature. The sun has an apparent temperature of about 6,000°K, and within a bandwidth comparable to that of the ruby maser emits about 1/20 watt per square centimeter. Masers emit kilowatts/cm<sup>2</sup>. Moreover, the sun radiates its energy in all directions, while the maser does not. For the sun to radiate as much optical power within the same frequency limits and solid angle as the ruby maser, its temperature would have to be  $10^{10}$  °K.

An unexpected discovery during the development of the ruby maser was that the output was not continuous. The output consists of a series of short bursts of emission during each pulse. Relaxation oscillations were obviously taking place.

Two other masers

Soon after the development of the first optical maser, two more pulsed masers were announced by the International Business Machines Corp. (IBM). Both the new masers used calcium fluoride as a host lattice. When the rare-earth element samarium was added to the CaF<sub>2</sub> crystal in small amounts, maser action was observed at 7,020 Å, or  $4.21 \times 10^8$  mc. It is also possible to include small amounts of uranium in crystals of CaF<sub>2</sub> during growth. The uranium causes a spontaneous fluorescence in the infrared ( $1.21 \times 10^6$  mc) which has allowed a maser to be operated at 2.49 microns. Both of the masers using CaF<sub>2</sub> have been cooled below 20°K when operated.

Although these masers—like the ruby—are operated in a pulsed manner, in the future continuous operation should be possible. This possibility results from the much lower power needed to produce an inverted population. The fluorescent transition does not involve return to the ground state as in ruby. It is a transition between two excited states. Therefore, to obtain an inverted population it is not necessary to excite

half the total atoms as in ruby, but only a small fraction of them. At present, the solid-material optical masers have all been pulsed.

The Bell Telephone Laboratory has recently observed optical maser action in dark red ruby, which has a higher chromium content than the pink type. The increased Cr<sup>+++</sup> content introduces new energy levels, which are used in the new maser. Optical maser action in the dark red ruby is at 4.28 and  $4.26 \times 10^8$  mc.

A gas maser

The first optical maser to operate continuously was announced recently by Bell Telephone Laboratories. It is a mixture of gaseous helium and neon. This system differs in appearance and mechanical details, but in the principles of inverted population and optical feedback is the same as described for ruby.

The gas maser is a meter-long glass tube, filled with a mixture of helium and neon in the ratio of 10 to 1. It looks superficially like an ordinary neon tube. The ends of the tube are partially transmitting plane parallel mirrors. These windows are aligned parallel to each other by an external optical system. External power to excite the atoms is supplied by a 28-mc generator delivering 50 watts. Most of this rf energy is coupled to the helium. Through collisions, energy is transferred from the helium to the neon atoms. This produces an inversion of the population between excited states in the neon atoms. The energy levels between which inversion occurs are not single pairs as in ruby and calcium fluoride. In fact, 32 such pairs are known to exist. Up to the present, maser action has been observed between only five of these pairs, producing frequencies of  $2.68 \times 10^8$ ,  $2.6 \times 10^8$ ,  $2.58 \times 10^8$ ,  $2.50 \times 10^8$  and  $2.48 \times 10^8$  megacycles in the near infrared.

The emission from the gas maser has, of course, all the properties of directionality, coherence and sharply defined frequency. Indeed, the frequency band emitted is only about 10 kc wide, which gives a fractional bandwidth of about  $10^{-10}$ . Due to the low density of atoms in a gas, the output power is less for gas than for solid-state masers.

Applications

With the development of these powerful, coherent and monochromatic light sources, many new uses of light will become possible. In the past, no light combined all three of these properties to the same extent and at the same time.

One immediate application would be optical radar. Since the wavelength is so much shorter than that of present radars, the resolution could be much higher. Radar systems operating at 1 cm with antennas several meters in height have a beam width, and hence definition, of about 0.5°. This might be compared with an optical maser ½ cm in width, with a beam width of .05°, which through the addition of a simple optical lens system an inch or so in diameter could easily be reduced to .005°. With such a narrow beam width,

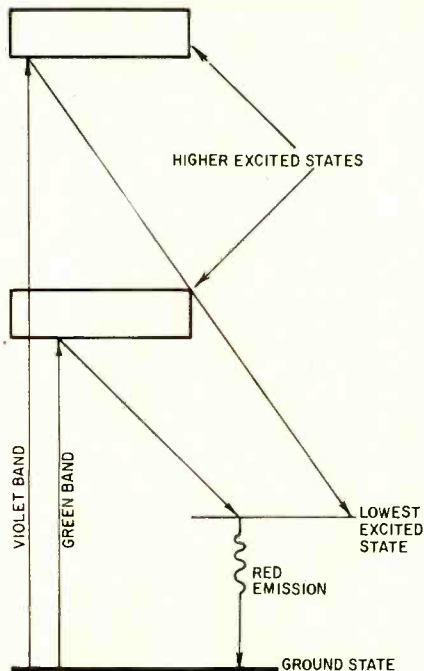

Fig. 4—Steps whereby absorption of green and violet light can be used to create an inverted population.

radar systems could easily identify the actual shapes of aircraft.

Because of the vast new frequency space that will be opened in the future, the communications industry is vitally concerned with maser developments. At present, communications links operate up to about  $10^4$  megacycles. The optical maser will extend that range to  $10^{14}$  cycles. This advance is particularly striking when one remembers that all of the frequency span now available to us is contained in 10% of the new region. To appreciate the significance of this, it is only necessary to realize that a color TV channel requires a bandwidth of nearly 10 megacycles. If the existing channels were used in a 10% modulation system, about 100 channels would be available. This is certainly adequate for TV but there is no space left for data transmission or telephony. On the other hand, an optical maser at  $10^8$  mc with a 10% bandwidth could handle  $10^6$  TV channels and still have a bandwidth of  $10^7$  mc left for other uses.

The directional property of optical masers will be useful in earth-to-satellite, satellite-to-satellite and earth-to-moon links. For example, if the output of an optical maser were sent through a simple lens system 4 inches in diameter, the radiation would cover only 2 miles at the surface of the moon. This indicates the possibilities of private communications.

In addition to these applications, the optical maser might be used as a tool to effect chemical reactions. Maser emission is coherent; it can therefore be focused into an area of dimensions comparable to wavelengths of light. Under these conditions all the maser energy could be concentrated within single living cells and selective destruction of tissue (surgery) be performed.

The optical maser can extend greatly the range over which interferometric measurements can be made. Present optical interference measurements are limited to about 100 cm due to inherent line width and low power of monochromatic sources, but significant increases in length are now possible.

We have mentioned a few new applications and scientific uses of light made possible by the optical maser. Most of the new uses will probably be in directions that are not yet apparent. However, we have indicated regions where it is thought uses will be found in the near future.

END

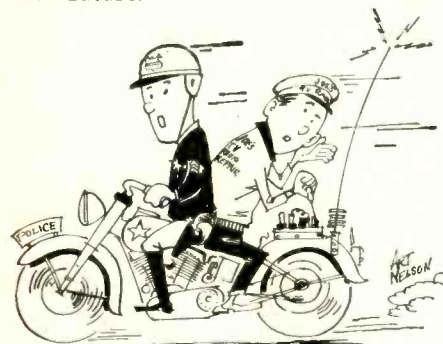

"Now listen to it start squealing when we get over 70."

# TV Service Clinic

conducted by  
**JACK DARR, SERVICE EDITOR**

This is your column in the magazine: the service is absolutely free; there is no charge for answering your questions, and your name and address will be kept confidential if you so wish. The main purpose of this is to help everyone working in electronics with their unusual problems; so send in your questions; each one gets an immediate personal answer. Later, the more interesting cases are published in the Clinic columns.

Due to the many peculiarities found in commercial TV circuits, you might find a different answer to a question than the one we give, even though the "conductor" of this column is himself a full-time professional TV technician. We would be interested to hear of such cases, as we feel that the more widespread the knowledge of such peculiarities, the better off we'll all be! So, if you have an unusual service job, or one which is giving you trouble from an obscure cause, send in a question on it; we'll answer it promptly and to the best of our ability. (Incidentally, you'd be surprised to know how many times we get a question concerning something on a given set, and then run into the identical condition in the next day or two! In this way, we get an actual check on the validity of our diagnosis.)

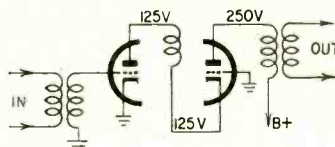
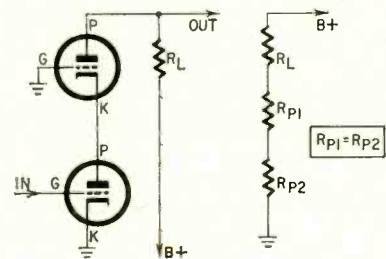

Fig. 1—The basic cascode circuit.

Fig. 2—In most cascode circuits, plate resistances ( $R_{P1}$  and  $R_{P2}$ ) are in series across the power supply.



QUITE some time ago, the cascode circuit was introduced. It looked nothing like the circuits seen up to that time, which was during WW II. Since its invention, it has become about the most popular single circuit in TV tuners (Fig. 1) and has found other applications. Actually, its basic circuit is pretty simple, as shown in Fig. 2. Still, a few TV technicians fail to recognize its basic simplicity, so let's run over some of its characteristics in actual TV tuner circuitry.

What is a cascode? It's a circuit using two tubes, in which the signal is fed directly from the plate of the first to the cathode of the next. What do we do with the grid of that last stage? Ground it! Basically we have a series circuit. We apply B-plus to the plate of the top tube through load  $R_L$ , which may be the primary of an rf transformer as in Fig. 1. Current flows through this tube, then on down through

the input (bottom) tube, and so to ground. In effect, we have put the plate resistances of the two tubes in series. So, if we're measuring dc voltages across this combination, what sort of division can we expect? If the two tubes are exactly the same, we ought to get exactly the same voltage drop across each one. In other words, each tube should have the same plate voltage, measured to its own cathode. If they become unequal, the circuit is upset and we've got troubles, usually appearing as snow.

Let's look at the signal circuits. The basic reason for using cascodes is their very superior noise figure. This, rather than absolute gain, is the most important parameter of any TV tuner circuit. So we use cascodes when we want maximum gain and minimum noise or snow. The circuit functions like this: The first "half" is a triode amplifier. Tube types specially developed for this

circuit, such as the 6BQ7, 6BZ7 and ECC189, are built with very close electrode spacing, giving them a very high mutual conductance (as much as 6,800 micromhos in some versions). We must set up the circuit to get the most usable gain out of it while retaining good stability. So we use a cascode. Since its second stage is a grounded-grid amplifier, we get an extremely stable circuit.

Now let's take some typical troubles encountered in the field. Tube defects in these circuits can cause some very peculiar troubles; some which might seem illogical at first, but which can be explained by a little thinking!

For example, you find three TV sets in a row. One will not pick up any high-channel stations, although the low-channel stations come in fairly well. The next one refuses to pick up low-channel stations, but gets the highs pretty well. And the last one gets both high- and low-channel stations, but is exceedingly snowy on all of them. The experienced TV technician would yank the rf (cascode) amplifier tube out and replace it on *all three*, first! This happens repeatedly in actual field work!

To be quite truthful, I haven't been able to come up with a valid explanation on the first two, although the last one is simple—the tube's just weak! But the solution is same for all three, replace the rf amplifier tube.

Heater-cathode shorts in the output section of the tube cause a lot of trouble, too. Because of the high voltage on the cathode, a short to the heater can burn out the filter resistor in the B-plus line feeding the stage. This is usually a ¼- or ½-watt 1,000- or 820-ohm resistor. When it goes, either the rf stage gets no B-plus at all or much less than normal—so down goes the gain and up comes the snow. So, when replacing a defective cascode tube, it is a good idea to measure the value of the plate filter resistor. This can be done easily in many sets. Take a reading from pin 1 of the 6BQ7 back to B-plus on the turner terminal board. If it is more than 1,000 ohms, look out!

#### No raster

A Westinghouse H14T171 came into the shop with no raster and insufficient high voltage. After changing all horizontal and high-voltage tubes and the selenium rectifier, to bring up the B-plus voltage, I now have insufficient width and about 6-kv high voltage. B-boost is about 300 volts.

I have changed the flyback, yoke, boost capacitor, coupling capacitor, afc network and other related parts. Resistance measurements are close to normal. Drive on the 12DQ6 is 64 volts peak to peak with about -16 volts bias. There is 98 volts at the plate of the first section of the horizontal multivibrator and -11 volts on its grid. If I connect a 400-volt boost from another set, high voltage rises to about 8 kv.—I. M., Holly Springs, N. C.

The key clue here is the drive voltage at the grid of the 12DQ6. It should be 90 volts peak to peak (Fig. 3), which should develop -20 volts dc bias! The

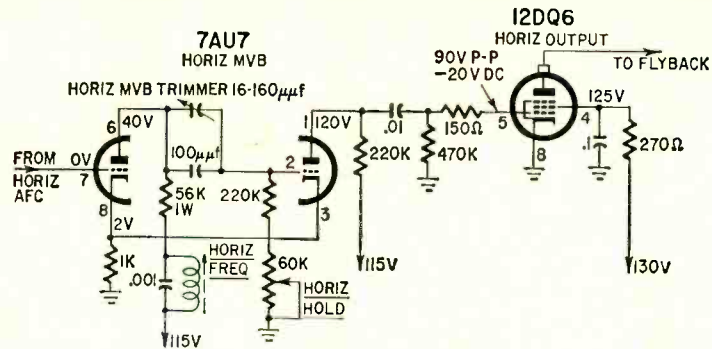

Fig. 3—Horizontal sweep circuit of Westinghouse H14T171.

lower voltage would cause the drop in high-voltage, boost, and all of the other symptoms.

Check the horizontal oscillator stage very carefully, especially the plate voltages and the tube itself. If it has been replaced, replace it again! Check the resistors in the waveshaping networks in the horizontal oscillator; they are fairly critical.

Another obscure defect which often causes such troubles in series-string filament sets is the heater voltages on critical tubes—damper, horizontal output and oscillator. Measure these voltages directly on the heater pins of the tubes, not at the socket lugs! We found one set which had only 7 volts on a 12-volt damper!

Finally, check the 115-volt line which feeds the 7AU7 plate through a 220,000-ohm resistor. Trouble here might be caused by video if tubes, bad audio tube, etc., upsetting the 115-volt line.

#### No brightness

There is no brightness on the screen of an Admiral 21D1 although the sound is OK. The 47-ohm resistor in the cathode of the 6BQ6 keeps burning up (Fig. 4). The grid reads -7 volts. The horizontal oscillator doesn't seem to be working right.—V. A., So. Ozone Park, N. Y.

The horizontal oscillator either isn't working at all or isn't working right. Grid voltage on the 6BQ6 should be at least 25 volts negative and closer to 34. The resistor is burning up because the 6BQ6 is not being driven hard enough to hold the plate current down.

Run a complete setup procedure on the horizontal oscillator, after substituting new tubes in both stages. Check all resistors and capacitors in the oscillator stage and replace the horizontal oscillator transformer if nothing else shows up.

#### Poor vertical linearity

I have a Tele-Tone TV-208 which has been butchered pretty badly. After a lot of work, I've got a picture and sound, but vertical linearity is bad. If I turn the vertical size control beyond a quarter-turn, the whole pix collapses. Also, there are bad retrace lines on the raster.—L. F. C., Haskell, N. J.

The collapse of the vertical sweep when the size control is turned may indicate a bad control or incorrect bias

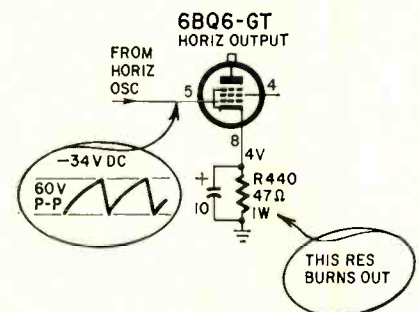

Fig. 4—Cathode resistor keeps burning out because of insufficient grid drive.

caused by leaky capacitors or bad resistors. Since the set has been butchered, check the whole stage carefully for wrong-value resistors and capacitors. Incorrect bias can make the stage stop oscillating when the size control is turned.

#### Color conversion

I have a 5TP4 projection tube with all high-voltage supplies, etc. I want to build a color TV projector using the Colordaptor system. Can you tell me what TV chassis to use?—K. M., Willow Grove, Pa.

Your best bet would be one of the older hot-rocks with four stages of video if, etc.—the Stewart-Warner 9126 and similar sets. These can be tuned to the required 5-mc bandwidth, essential for good color reception, and have plenty of gain. Some of the older custom-built, like Fleetwood, Tech-Master, etc., should also work.

#### Whiteout

In a Philco 7L70, the picture comes on fairly good. Within a few minutes, it begins to grow whiter and whiter, until there is a bad loss of detail in the highlights and an apparent loss of focus. I suspected the picture tube, but it seems to be all right, at least on our checker. All the voltages on the picture tube check OK. What is causing this "whiteout"?—M. I. S., New Braunfels, Tex.

This is due to a defective 12BV7 video amplifier tube. The exact nature of the defect is rather obscure as the tube will check fairly good in a tube tester. It is probably due to some occluded gas in the tube which causes it

(Continued on page 64)

Only Heath offers  
Top Quality at the  
Lowest Price, and ....



**NOW**—*we guarantee you*

**At your service . . .**

**THE NEW HEATHKIT AUTOMATIC GARAGE DOOR OPENER!**

Compare price, compare features, and you'll buy this latest Heathkit labor-saving wonder! Opens and closes all overhead track-type doors up to 8' high automatically! Garage light turns on when door is open, stays on for short period after door closes! Safety release device. Adjustable operating force! Tone-coded "hi-power" 6 or 12 v transmitter and special receiver prevents interference. Easy one-man assembly. All parts included. 65 lbs.

Kit GD-20 (mechanism, transmitter, receiver) . . .  
\$11 dn., \$10 mo. . . . . **\$109.95**  
Kit GDA-20-1 (extra transmitter) . . . \$2.50 dn., \$5 mo. . . . **\$24.95**



**BIG-BUY PORTABLE 4-TRACK STEREO TAPE RECORDER**

All-in-one monophonic or 4-track stereo tape record and play-back! Two tape control levers; individual tone balance and level controls; monitoring switch for listening while recording; "pause" button for editing; two "eyes" to check recording levels. Also functions as "hi-fi stereo center" for record players, etc., or to feed tape music to separate hi-fi system. Parts for all amplifiers and speakers included; turquoise and white cabinet and 3 3/4" — 7 1/2" speed tape deck are assembled. Less mic.

Kit AD-40 . . . 49 lbs. . . \$18 dn., \$16 mo. . . . . **\$179.95**  
Assembled ADW-40 . . . 49 lbs. . . \$30 dn., \$26 mo. . . . . **\$299.95**



**NEW HIGH FIDELITY PA AMP.**

Heath exclusive; 20 watt *hi-fi* rated PA amp. Two inputs; equalization switches; electrical mixing; sealed "pads"; tape recorder, line, and voice coil output. Plug-in, low-Z mic. Xformers separate. 24 lbs.

Kit AA-31 . . .  
\$6 dn., \$6 mo. . . . . **\$59.95**  
Mic. Xformers, AN-11 **\$11.95**

**"LEGATO-COMPACT"**

All Altec Lansing speakers! 2-12" hi-compliance woofers; exponential horn and driver; range 30-22,000 cps; assembled. 800 cps network. 30 watts program; 16 ohm Z. Assembled, finished cabinets; 32" l x 19" d x 32 3/8" h 132 lbs.

Kit AS-21U, unfin. . . **\$224.95**  
Kit AS-21W, wal. . . **\$229.95**  
Kit AS-21M, mahog **\$229.95**



**HEATH COMPANY** Benton Harbor, Michigan

a subsidiary of **DAYSTROM, INCORPORATED**

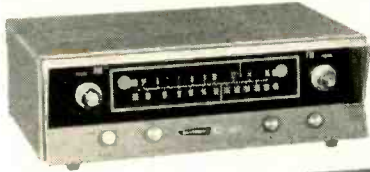

Introducing a new styling concept in two popular Heathkit Stereo Units



Here's a handsome matching pair for your new Heathkit stereo system! Both have new louvered wrap-arounds of luggage-tan vinyl-clad steel with contrasting charcoal-grey front panels framed with polished aluminum bezels . . . a regal new look to Heath's medium-price stereo line.

**HEATHKIT AJ-11 AM/FM TUNER**

Successor to the popular AJ-10, this new version features fly-wheel tuning, two "magic-eye" tuning indicators, adjustable FM automatic frequency control, AM "fidelity" switch for max. selectivity or fidelity, dependable 12 tube circuit, built-in power supply. 21 lbs.

Kit AJ-11 . . . \$7 dn., \$7 mo. . . . . **\$69.95**  
 Assembled AJW-11 . . . \$13 dn., \$11 mo. . . . . **\$129.95**

**HEATHKIT AA-151 28-WATT STEREO AMPLIFIER**

Here's the popular SA-2 model all dressed up in brand-new styling. Delivers 28 hi-fi rated watts (14 per channel) for plenty of power. Has clutched volume controls, ganged tone controls, 4 dual inputs. 28 lbs.

Kit AA-151 . . . \$6 dn., \$6 mo. . . . . **\$59.95**  
 Assembled AAW-151 . . . \$12dn., \$11mo. . . . . **\$119.95**

*can build any Heathkit!*



**IGNITION ANALYZER**

Switch to primary, secondary, parade or superimposed patterns. See condition of plugs, points, wiring, coil & condenser. Plug-in ID-11 Timing Light available. 15lbs.

Kit IO-20 . . . \$9 dn. . . . . **\$89.95**  
 Assembled IOW-20 **\$169.95**



**NEW TELEPHONE AMPLIFIER!**

Hands-free phone chats! Ideal for conferences, dictation, etc. Place handset on cradle, unit turns on, instantly ready! All-transistor; long-lasting battery power. Easy to build. Ivory color.

Kit GD-71 . . . . 4 lbs. . . . **\$19.95**



**LOW COST DEPTH SOUNDER**

Best value in marine electronics. Detects fish, submerged objects, and bottom depth. Big 4 3/4" dial calibrated from 0-100'. 6-transistor circuit, battery powered. Corrosion & splash-resistant aluminum cab. Transducer included. 9 lbs.

Kit MI-10 \$7 dn., \$7 mo. **\$69.95**



**LOW COST 3-BAND MARINE RDF**

Deluxe features at minimum cost. Covers 200-400kc beacons, 550-1600 kc broadcast, 1700-3400 kc marine band. Loop and "sense" antennas eliminate double null. 9-transistor circuit, battery powered. Pre-assembled tuning unit.

Kit DF-3 12 lbs. \$10 dn. **\$99.95**

**You get guaranteed success with Heathkit!**

Never before has a manufacturer of do-it-yourself kits guaranteed your success in completing a project. Heath does so and backs it up with an iron-clad, money-back guarantee! By making this guarantee, we hope to banish any doubt you may have about your ability to build a kit. How is such a guarantee possible? The careful planning that goes into the design of Heathkit equipment revolves around this paramount thought—anyone, regardless of background or experience, must be able to build any Heathkit. This same thought guides the writing of the detailed Heathkit assembly instructions with the world famous "check-by-step" system. These attributes plus the experience of a million customers attests to the fact that anyone can build a Heathkit. Order your favorite Heathkit today. Enjoy top quality equipment with savings of up to 50% and the satisfaction of doing it yourself. Get guaranteed success with Heathkit!

**MONEY BACK GUARANTEE**

The Heath Company *unconditionally guarantees* that you can build any Heathkit product and that it will perform in accordance with our published specifications, by simply following and completing our check-by-step instructions, or your purchase price will be cheerfully refunded.

**FREE Catalog!**



Contains complete descriptions and specifications on all of the above new models plus more than 200 other famous Heathkit items. Send for your free copy, use the coupon below; see how you can enjoy top quality equipment with savings of up to 50% with Heathkit!

Ordering Instructions: Fill out the order blank. Include charges for parcel post according to weights shown. Express orders shipped delivery charges collect. All prices F.O.B. Benton Harbor, Mich. A 20% deposit is required on all C.O.D. orders. Prices subject to change without notice. Dealer and export prices slightly higher.

Please send the following items:

Item	Model No.	Price

Order direct by mail or see your Heathkit dealer.

Ship  Parcel Post  Express  C.O.D.  Best Way



**HEATH COMPANY**  
 Benton Harbor 20, Michigan

PLEASE SEND MY FREE COPY OF THE 1961 HEATHKIT CATALOG

Name \_\_\_\_\_

Address \_\_\_\_\_

City \_\_\_\_\_ Zone \_\_\_\_\_ State \_\_\_\_\_

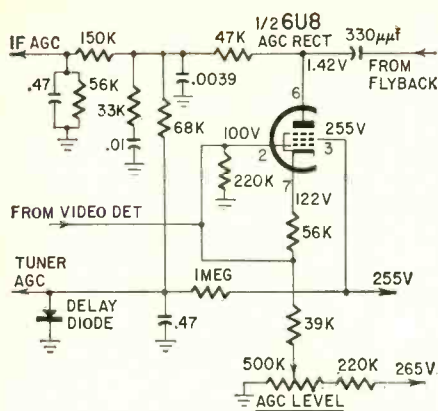

Fig. 5—Agc circuit of RCA 21T6082.

(Continued from page 61)

to become gassy after full heating up. Gas currents in the grid will cause the plate current to be erratic, thus limiting the gain of the tube—and reducing the amplitude of the video signal. Since the amplitude of the video signal determines the blackness of any portion of the picture, you get a whiteout.

#### Agc at fault?

*I'm having trouble with an RCA 21T6082. I'm sure it's in the agc since I can ground out the agc and get a good picture. When I first turn it on, there is 54 volts on the agc tube. Ac feedback voltage from the flyback is 300.—E. E. H., W. Haven, Conn.*

This is agc trouble. Your key reading is that positive voltage on the plate of the agc rectifier.

The trouble lies in that agc plate. It should never go positive by that amount. This is probably due to trouble somewhere in the voltage-divider resistors which feed that circuit (Fig. 5 shows proper values and voltages). Any incorrect resistances in here would upset the critical voltage distribution around this section of the tube but good. That signal voltages are obviously getting to the grid as they should is shown by the voltage variations you noted.

#### Poor noise immunity

*One of our customers has a 1955 Fleetwood, with very good picture quality, etc., but pretty poor noise immunity, especially to automobile ignition noise. We believe that the circuit*

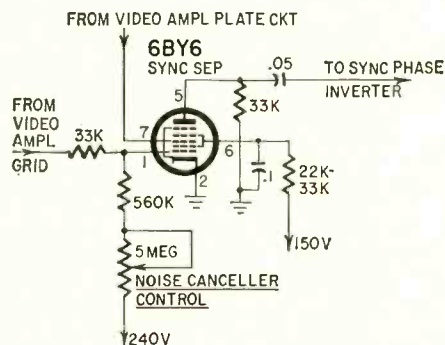

Fig. 6—Modification of Fleetwood noise-cancelling circuit. Values are determined by experimenting.

*could be changed to help this. Our idea was to hold one stage of video amplification constant and move the contrast control to the cathode of the last video amplifier. The sync takeoff would be ahead of this point.—M. & G., Cobden, Ontario.*

Unless I'm misreading the schematic, this chassis now seems to have practically no provision for noise cancellation, although it does use the 6BY6 tube widely used for this purpose in many later models. Therefore, I believe I'd leave the video amplifier stages alone and rework that 6BY6 stage to make it the same as the circuit used in the newer sets (Fig. 6).

This should give you better noise immunity. The present contrast control in this set is actually an agc control, similar to the circuit used in the old G-E 800 series. It regulates the gain of the video if amplifiers. Therefore, it should be set carefully for best results. Check all of your video if tubes for gas. Check the horizontal afc circuit very carefully, replacing all resistors that show more than 5% deviation from rated values and all capacitors that show any signs of leakage.

One further suggestion. You might solve the whole problem by increasing the signal level! Use a higher-gain antenna with an antenna booster that will give about 25 db gain. The use of coaxial-cable (72-ohm) lead-in will eliminate quite a bit of ignition noise pickup, but you'll have to "replace" the signal lost. The best way is with an antenna booster.

#### Vertical rolling

*In a Motorola 10VT10R, the picture starts to roll after 15 minutes and the vertical hold control has no effect. What is probable cause?—F. B., San Diego, Calif.*

From the 15-minute time constant of this trouble, it would seem to be thermal. The trouble doesn't show up until the set has had time to get warmed up. This would point to a resistor—troubles due to capacitors or tubes show up more quickly.

Check the resistors in the plate and grid circuits of the 6J5 vertical oscillator. Hold the tip of a soldering iron on each one with an ohmmeter connected across it. You'll probably find one of them change drastically as it heats up.

If this doesn't cure the trouble, check the coupling and time-constant capacitors, using a capacitor checker which reads leakage. Slight leakage in a coupling capacitor can give you the same effect, although drifting resistors are the more common cause.

#### Visible drive line

*The subject is a Silvertone 528.631-1. I'm having difficulty getting rid of the vertical white line usually associated with misadjustment of the horizontal drive control. Turning the control one way makes the line very bright. Turning the other way makes the line break up into three lines at the right side. At this point the picture gets darker and*

precision  
loudspeaker

# NEW SYSTEMS

with 15"  
long-excursion  
transducer

A dramatic achievement, the JBL LE15 signals a new era in precision reproduction of fundamental frequencies. This is the only 15" driver capable of 3/4" cone excursion; free air resonance is about 20 cps. The LE15 is further distinguished by a 4" copper ribbon voice coil, cast frame, efficient magnetic circuit, and JBL craftsmanship. It is the base (as well as bass and basis) for three new divided network systems with choice of high frequency units and a new slant-plate acoustical lens. An exquisite new infinite baffle enclosure, the Olympus, is designed for these systems. Hear the finest in new sound at your Authorized JBL Signature Audio Specialist. Write for his name and your free copy of Bulletin SL612.

JAMES B. LANSING SOUND, INC., Los Angeles 39

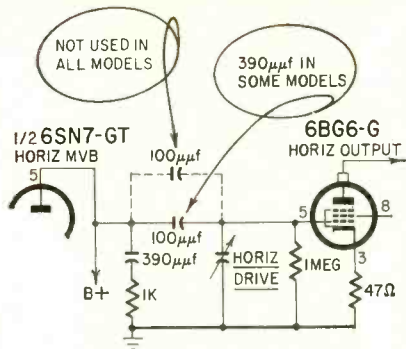

Fig. 7—Drive line may be caused by leakage in horizontal drive trimmer.

is beyond tolerance.—D. R., Newcastle, Pa.

This is undoubtedly a drive line. The horizontal drive in this chassis is the shunt type—a small trimmer capacitor connected from the 6BG6 grid to chassis (Fig. 7). I note that they use an extra capacitor in shunt across the coupling capacitor, as shown. Disconnect both of these and check for leakage. Quite often the trimmer capacitors used here develop leakage from moisture. Take it completely apart and replace the mica.

Check the waveform at the 6BG6 grid. It should be a good, smooth sawtooth, at 45 volts peak to peak. If it is incorrectly shaped, with ringing, etc., go back into the oscillator circuit and check all the waveshaping R-C networks.

#### Lower the if?

I would like to change the sound if in a TV turret tuner to 10.7 mc, and run it through a regular FM if strip and detector.—J. C., Davis, Calif.

I'm afraid not! The sound and picture frequencies in a tuner are heterodyned with the local oscillator and come out as the video and sound if's. Actually, the 4.5-mc sound if never appears in the tuner at all, but shows up first in the video detector! It is a product of a beat between sound and picture carriers in the nonlinear detector.

To do what you suggest would require adding another oscillator in the tuner! I don't think you'd gain much by trying this, and it would be a difficult job! END

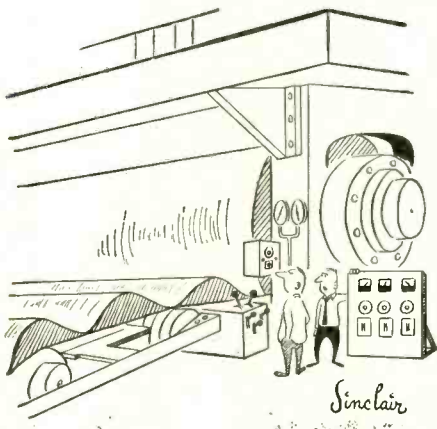

"I think you're picking up 60-cycle hum on the thickness control."

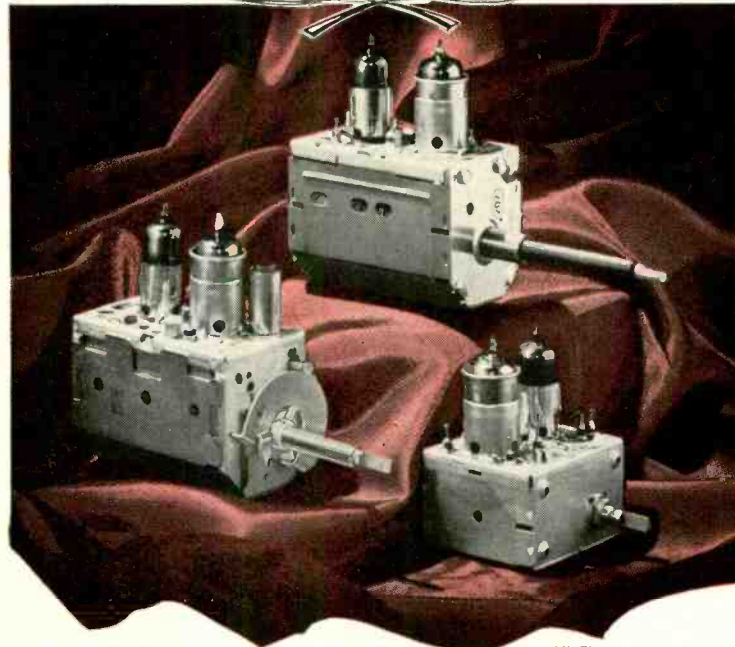

SILVER SEALED  
(switch-type)

HOT ROD  
(turret-type)

HI FI  
(FM) Tuner

It's only natural that the world's leading set manufacturers should rely on the TARZIAN TUNER . . . acclaimed as the world's finest.

Today, TARZIAN TUNERS are providing unexcelled performance in millions and millions of television receivers. Since the beginning of television (Sarkes Tarzian was a pioneer in the industry) leading set manufacturers have been equipping their receivers with TARZIAN TUNERS because they are assured of dependable performance. And, at Low Cost.

Sarkes Tarzian, Inc. is recognized as the world's leading commercial tuner manufacturer with licences in Canada, Mexico, Brazil, Argentina, Australia and Italy.

Only Tarzian offers manufacturers both the HOT ROD (turret-type) and SILVER SEALED (switch-type) . . . as well as the Hi Fi FM Tuner. All embody the high standards of QUALITY . . . DEPENDABILITY . . . and OUTSTANDING PERFORMANCE that have made TARZIAN products a leader in the field.

For more information, write to: Sales Department, Tuner Division



SARKES TARZIAN INC

east hillside drive • bloomington, indiana

Manufacturers of TV and FM Tuners • Closed Circuit TV Systems  
• Broadcast Equipment • Air Trimmers • Magnetic Tape • Semiconductors.

Atomic-Age version of the old flashlight continuity checker also doubles as leakage indicator, capacitor checker and signal injector

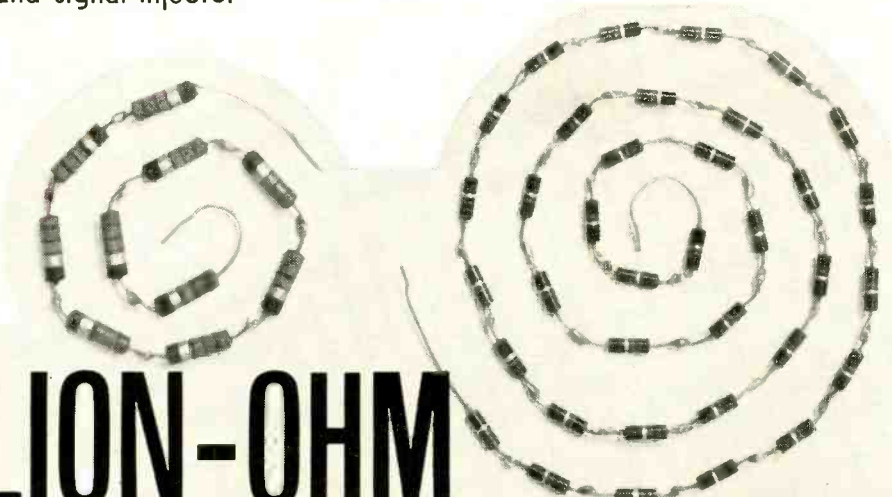

Small spiral consists of 10 25-megohm resistors; large spiral of 36 22-megohm resistors. Total 1,042 megohms!

# BILLION-OHM

# CONTINUITY CHECKER

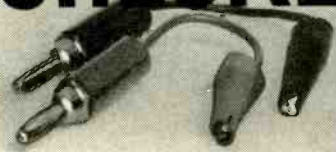
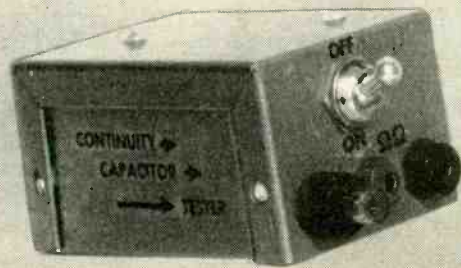

By JACK LIPINER

IN actual tests with this completed miniature continuity tester, the neon indicator still glowed brightly with a resistance of 1,050 megohms in the circuit, and looked as if it might go much further! Such a demonstration of resistance-range capacity places this small, battery-powered tester in the sensitivity range of vtvm's. It far surpasses the limits of sensitive multimeters, whose high ohms range seldom goes above 100 megohms.

Fig. 1 is a simple circuit for low-resistance continuity and short checking. However, when resistance between the test prods reduces battery voltage to the point where the incandescent lamp cannot light, the device ceases to operate. Fig. 2 is a table of approximate  $R_x$  resistance limits for battery voltages from 3 to 12 for various lamps. With higher values of  $R_x$  the lamps won't light. As you can see, the  $R_x$  limit increases directly with the applied volt-

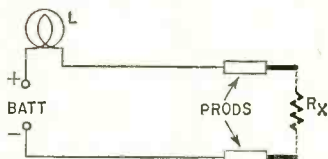

Fig. 1—Simple circuit for checking continuity.

age. A simple 3-volt flashlight continuity and short checker is very useful around the shop, but limited to resistances up to 10 ohms.

With the ever-present desire to make miniature testing devices, the problem is how to increase the voltage supply in a continuity checker to meet the usual requirements of testing for continuity, leakage, shorts and yet not require bulky batteries which would make the instrument larger.

In the November 1954 issue of RADIO-ELECTRONICS, page 125, is a schematic (Fig. 3) of a small continuity checker which meets the requirements of a larger voltage supply. This schematic is based on an article by G. A. French in the *Radio Constructor* (London, England), in which the tester operates from a 6-9-volt dry battery. Higher voltage to send the current through high resistances is delivered by a vibrator type supply which uses a 6-volt buzzer.

The article in RADIO-ELECTRONICS states: "When the switch is turned on, the buzzer functions, resulting in the rapid collapse of the magnetic field, which, in turn, induces in the coil a voltage many times higher than the initial battery voltage. This higher voltage is rectified, filtered and then applied to the neon indicator. The brightness of the glow in the neon is determined by the resistance between the test prods."

There is no description of an actual tester. However, there is a final statement: "A miniature battery and buzzer will enable you to tuck this instrument into a pocket-size cigarette case." The resistance limit in the article is estimated: "... checks leakage and continuity up to about 10 megohms."

This estimate was extremely modest! Following the 1954 circuit, with modifi-

Battery Volts	Lamp L	Limit— $R_x$ Resistance Ohms
3	No. 222	10
6	No. 425	20
9	No. 993	115
12	No. 993	150

Fig. 2—Approximate resistance limits for continuity checkers using the Fig. 1 circuit.

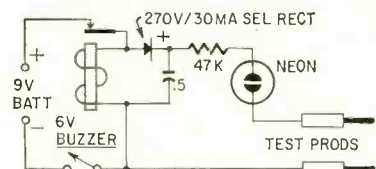
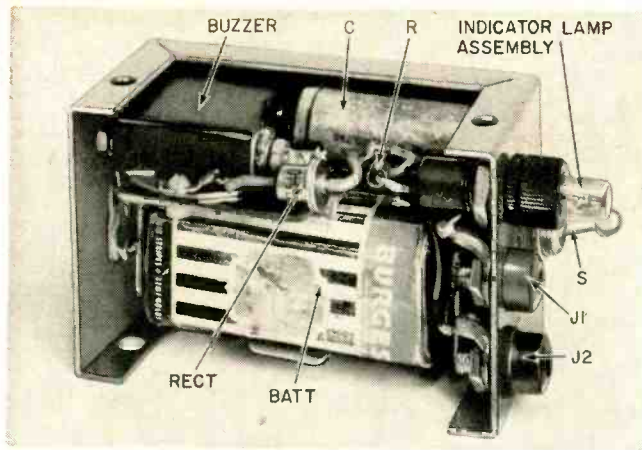

Fig. 3—Circuit of 10-megohm continuity checker which appeared in *Radio-Electronics*, November, 1954.





Inside the checker space is at a premium.

A simple continuity checker of the type shown in Fig. 1. Lamp is in end of probe.



ctions where necessary, I built the instrument shown in the photos and Fig. 4. Powered by a 6-volt battery and Fig. 4. Powered by a 6-volt battery, the device indicates circuit continuity even with a series resistance in excess of 1,000,000,000 ohms! This is 100 times greater than the 1954 estimate! On the opposite end of the scale, the simple continuity checker of Fig. 1 (this time with a 6-volt battery) will not register continuity of resistances over 20 ohms. By adding a buzzer, capacitor and rectifier, the checker (Fig. 4) becomes 50,000,000 times more sensitive.

### Construction

The smallest case that will house the components satisfactorily measures  $3\frac{1}{4} \times 2\frac{1}{2} \times 1\frac{1}{2}$  inches. The photos show the suggested parts layout.

The vibrator power supply is built around a 6-volt buzzer (Edwards No. 15). It has only two screw connections, so point X in Fig. 4 is the buzzer case. Fasten a solder lug to the case and connect the negative side of the silicon rectifier to it.

The battery is held in place by a battery holder which is fastened to the case with two No. 4/40 nylon screws attached to a  $1\frac{1}{2}$ -inch square of insulating bakelite strip. This strip is fastened with two No. 2/56 nylon screws to one bracket of the battery holder. As stated above, the top buzzer supporting screw also holds the solder

lug for one side of the rectifier. To avoid contact with the outside metal case, tape the front cover of the buzzer, also the top, inside, bottom and sides of the outside case at all possible contact points with strips of electrical tape.

The Dialight Corp. neon indicator employs the NE-2H lamp which gives a brighter glow than the ordinary NE-2. The Dialight No. 7538 holder with a replaceable No. 38H-1533 lamp cartridge is very efficient, occupies minimum space, and enhances the appearance of the checker.

The on-off switch is the standard miniature spst toggle switch with two wire leads already attached. This switch is available at most electrical supply retailers. You can pick up the buzzer at the same time.

Most 0.5- $\mu$ f 400-volt capacitors are rather long and bulky. However, a suitable capacitor is the Solar Solite metallized-paper unit which measures about  $19/32 \times 1\frac{1}{2}$  inches. Other metallized units of equivalent size can also be used.

### Operation

When the switch is turned on, the buzzer starts. To determine if the neon indicator is functioning, short the test prods. If the neon does not glow, reverse the battery for proper polarity. After obtaining a neon indication with direct shorting, check continuity of resistances between the prods by observing the neon for glow.

The versatility of this tester is demonstrated by its ability to check several features of vacuum tubes. The usual lower-priced tube tester will check direct shorts and interelectrode leakage up to about 250,000 ohms. Since many circuit aberrations are traced to leakages exceeding this resistance limit, the usual tube checker is unable to detect them. Mutual conductance ( $g_m$ ) testers costing about \$200 or more usually feature interelectrode leakage tests up to about 20 megohms. The billion-ohm continuity checker provides tests for filaments, shorts and all high-resistance interelectrode leakages. Thus, it becomes a valuable accessory to any tube checker.

While this device is not primarily a signal injector, it can be used for this purpose. When coupled through a suitable capacitor to a broadcast re-

ceiver, signal injection was effective at the usual application points along the entire path. Sometimes only one prod was sufficient but for stronger response both prods were employed.

Mica and paper capacitors can be tested for opens, shorts and leakage by the glows and flashes of the neon indicator. To obtain standards for capacitor tests, establish the response of a good capacitor and compare this standard with results obtained in future tests. A direct short or bad leakage will approach a steady flash or bright glow. Fainter flashes or glows at varying rates indicate gradations of quality of the capacitor.

The neon will continue to glow after a high-resistance continuity test (the resistance still attached to the prods), even after the switch is thrown to the off position. This is caused by the charge remaining in the unit's filter capacitor. Short the prods (you'll get a bright flash in the neon) to discharge the capacitor.

Even though a 6-volt battery is the basic power supply, the buzzer produces enough voltage to cause a rather stinging shock if the unwary operator touches both bare prods at the same time while using the tester.

The increased range of this tester over that of the unit in Fig. 3 can be attributed, possibly, to the use of the NE-2H or the silicon rectifier or both.

Standard 6-volt transistor batteries will not make an efficient power supply for this tester since the buzzer draws a higher current drain than these batteries can deliver, even for a short period of time. The Z4 battery was chosen as more efficient. However, it is never advisable to keep the buzzer operating for long periods, since current drain is high. This battery will function satisfactorily for the short periods required for ordinary testing.

Because of the type of current produced in this checker, low resistances can be tested without damage to them. Continuity tests were made on No. 222 penlight lamps, on 6- and 12-volt tubes, without injuring their filaments.

If, in the future, a smaller buzzer is produced which draws less current and requires a smaller-sized battery, it is likely that this instrument can be housed in a case the size of a penlight flashlight.

END

- BATT—6 volts (Burgess Z4 or equivalent)
- C—0.5  $\mu$ f, 400 volts, metallized paper
- J1, J2—insulated banana jacks
- R—18,000 ohms,  $\frac{1}{2}$  watt
- RECT—400 PIV, 500 ma, silicon (General Instruments Corp. PT-540-J9)
- S—spst toggle switch, with wire leads (Cutler-Hammer 8391-K7 or equivalent)
- Buzzer, 6 volts (Edwards Co. No. 15 or equivalent), obtain from electrical supply house
- Neon-lamp assembly (Dialight No. 7538-38H-1533 or equivalent)
- Nylon machine screws, 2/56 with nuts (4)
- Nylon machine screws, 4/40 with nuts (2)
- Case,  $3\frac{1}{4} \times 2\frac{1}{2} \times 1\frac{1}{2}$  inches
- Miscellaneous hardware, etc.

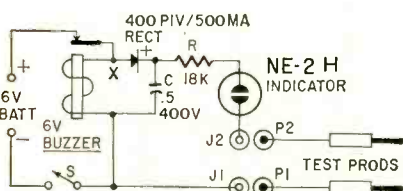

Fig. 4—Circuit of 1,000-megohm continuity tester.

# ELECTRONIC NUMBERS PUZZLE

By JOHN A. COMSTOCK

LIKE to work with numbers? Here is a puzzle that is built around some of the numbers often used in radio and television. Many of them are already familiar to you. Others you will have to work out, using pure logic and, in some cases, simple math and an electronics formula.

If you find crossword puzzles entertaining, you'll enjoy every minute of this puzzle. It's something new—fun to do—educational, too!

(Answers on page 110)

## ACROSS

1. In monochrome TV, the horizontal scanning frequency.
4. The frequency (in kc) received by a superheterodyne receiver with a 456-kc if and the local oscillator operating at 1056 kc.
5. The voltage drop across a resistance of 65 ohms when current flow through the resistance is 1 ampere.
6. A common 3-phase power voltage.
8. The wavelength in meters of a 3-mc signal.
9. The decimal by which milliamperes must be multiplied to convert to amperes.
10. The total number of lines in one frame of monochrome television.
12. The lower limit of TV channel 2 in megacycles.
14. A common intermediate frequency often used in AM superheterodyne receivers.
16. In rpm, a fast record-player speed.
17. One of the slower record-player speeds in rpm.
19. The vhf TV channel that extends from 204 to 210 mc.
20. 500 micromicrofarads converted to microfarads.
21. 950,000 watts expressed in kilowatts.
22. TV aspect ratio.
24. The year Marconi invented the first wireless telegraph.
25. The approximate number of degrees plate current flows in a class-B amplifier.
28. The frequency in kilocycles of a 429-meter signal.
30. The value of a resistance when voltage drop is 160 volts; current flow, 2 amperes.
31. The upper limit in megacycles of the vhf spectrum band.
33. The second harmonic of 376 kilocycles.
35. The power dissipated in a resistance when voltage drop equals 46 volts; current flow 1 ampere.
37. The value of a resistor color-coded brown, green and orange.
40. The year official television broadcasts began in New York.

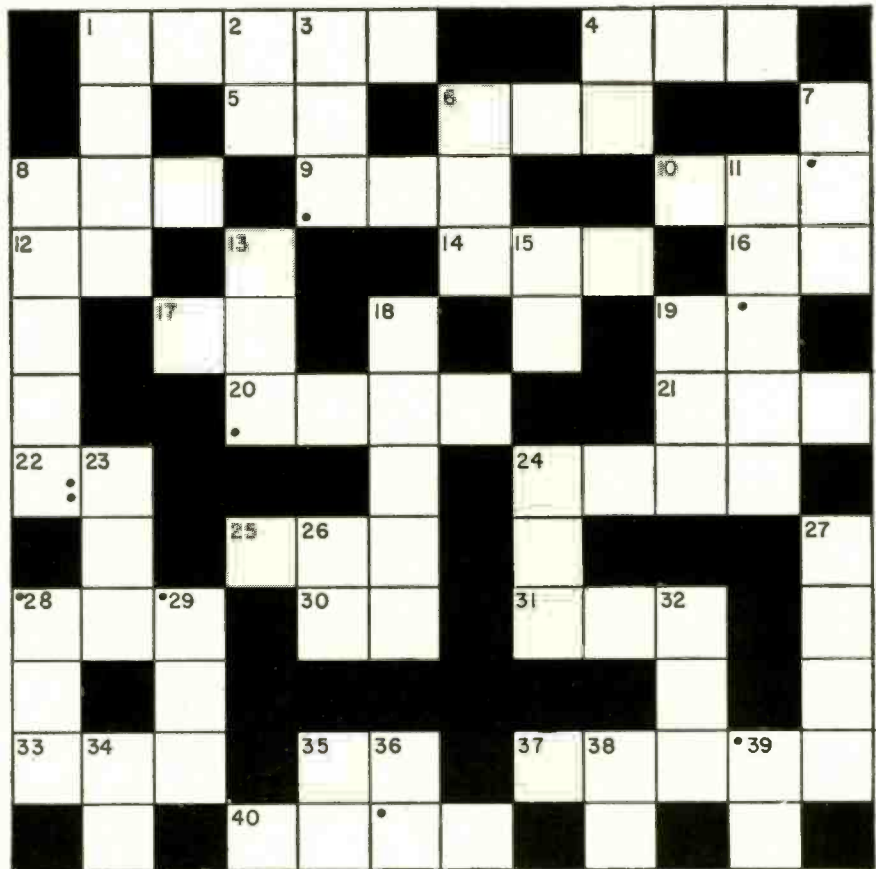

## DOWN

1. The year Fleming invented the diode vacuum-tube detector.
2. The lower limit in megacycles of TV channel 5.
3. In kilocycles, the original lower limit of the commercial AM broadcast band.
4. The field-frequency rate of television.
6. The voltage drop across an ac circuit when impedance is 107 ohms; current flow, 2 amperes.
7. In color TV, the color burst frequency in megacycles.
8. The horizontal scanning frequency used in color television.
11. The frequency in the Citizens band assigned exclusively to the radio control of model planes, garage-door openers, etc.
13. The watt-hour power consumption of a 75-watt portable TV operated for a total of 2 hours.
15. The heater voltage of a vacuum tube such as the 50L6, 50C5, etc.
18. The output in meters of a transmitter operating at 30 kilocycles.
19. The peak voltage output of a power supply which has an effective voltage output of 141.
23. The common impedance in ohms of TV ribbon type twin-lead.
24. A common high-voltage half-wave rectifier often found in TV sets.
26. The lower limit of the FM broadcast band expressed in megacycles.
27. The capacitive reactance of a 0.5- $\mu$ f capacitor at a frequency of 60 cycles.
28. The factor by which the peak value of an alternating current or voltage must be multiplied to find the effective value.
29. 12 milliamperes of current expressed in amperes.
32. The number of zeros represented by the letter K used in resistor values.
34. The mid-frequency of TV channel 2.
35. The total resistance in ohms of two resistors (one 27 ohms, the other, 22 ohms) connected in series.
36. The heater voltage of a 6BQ6.
38. The total capacitance of two 25- $\mu$ f capacitors connected in parallel.
39. .00004 ampere expressed in milliamperes.

Some service hints that help take these tricky circuits out of your hair

# Servicing stacked-B circuits

By JACK DARR

RADIO-ELECTRONICS SERVICE EDITOR

**S**TACKED-B circuits are up near the top of the service technician's headache list. Properly designed, a stacked-B supply is a good circuit and works as well as any other kind.

The basic arrangement is simple. Most sets already have a positive 250—375 volts on hand for high-voltage and sweep circuits. We just apply this excessively high voltage across a combination of two lower-voltage circuits. By connecting them in series—plate of one to cathode of the other—we can use the high B-plus without heavy divider resistors.

We use one high-current power amplifier, usually in the audio output stage, in the "top" half of the circuit, and tie a group of other tubes, usually all voltage amplifiers (low-plate-current types) "below" it (Fig. 1).

By selecting the proper tube types, we can get whatever current we need for the bottom half of the circuit.

For example, if a 6V6 or 6AQ5 is used in the top half, we can set it up for

about 2 watts audio output (ample for home use) and have about 180 volts on plate and screen, with a 30-ma cathode current. With these values, we can tie on any number of tubes until we reach our total of 30 ma cathode current. For example (Fig. 2) if we had six tubes, each requiring 5 ma, we would come out just right.

The designer usually does things the other way around. He selects the tubes he wants in the bottom half of the circuit, then for the upper half chooses a power tube that will give him the proper cathode current. Adjusting operating voltages and power-tube bias gives him the values he needs. For this reason, operating voltages are always critical in this type of circuit, much more so than in conventional ones. Some actual examples will be given in a moment.

If the technician can always remember that this hookup is simply a voltage divider, he won't have any trouble seeing the circuit in his mind. They are exactly the same—vacuum tubes are used in place of fixed resistors, that's all.

Now, with our "voltage divider" properly balanced, we portion out the available supply voltage between the top and bottom halves. While the peak supply voltage shows quite a bit of variation, from 250 to 275, the bottom half seems to be 150 volts, in all of the sets I've checked over. This is a good average value of supply voltage for video if plates and similar applications, and this is probably why it was chosen.

Let me repeat once more, for added emphasis, that this whole circuit is basically a dc voltage divider, with vacuum tubes used in place of fixed resistors. The "resistor" in each half of the circuit is the tube's dc plate resistance.

## Commercial circuits

Now let's look at a few examples of how this principle is used in actual circuits. Note how it divides almost equally between the two halves.

This circuit is used in quite a few recent TV sets in first and second video if stages (Fig. 3). Identical tubes are used here, but they need not be. Other types could be used by adjusting plate and screen currents. Notice the operating voltages indicated at the tube elements. The division is almost exactly half in this particular set. By adjusting bias voltages the designer can cause either tube to take any desired share of the voltage. Correct voltages are shown in the service data for each set. If you get trouble in these stages, it will almost always show up as unbalanced dc voltages.

There is one more case (fortunately pretty rare) where initial voltage measurements might mislead you into thinking that you had a stacked-B circuit in the video if. Standard design practice of late seems to be stacking the first two video if's, with the highest plate voltage being applied to the second. In the Bendix 21K3, seen in Fig. 4, the highest plate voltage is applied to the first video if! Checking grid and cathode voltages indicates that this stage must be stacked with another, somewhere! Check the schematic carefully, and we find that the 230 volts on the cathode of the 6BA6 is used as the B-plus supply for the 6BQ7 in the tuner! This, in effect, is a triple stack of tubes, since the 'BQ7 itself is stacked (Fig. 4-b).

## Servicing

These circuits can be difficult to serv-

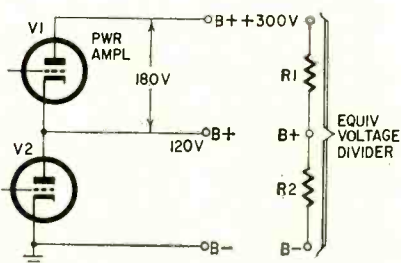

Fig. 1—Basic stacked-B circuit. Tubes act as a voltage divider.

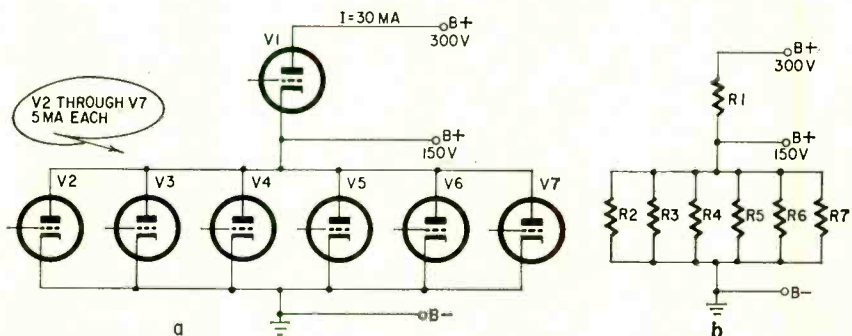

Fig. 2—a—Typical stacked-B circuit. b—Equivalent circuit.

ice because of the interdependence of the tubes for operating voltages. A defect in one stage can cause trouble in another. Fig. 5 is a good example of this. It's a very strong hum bar, and 60-cycle hum bars, as everyone knows, are *always* caused by heater-cathode leakage in the video if or video amplifier tubes. Oh, yeah? This one was caused by a shorted 6AQ5 in the audio output stage of a stacked-B circuit. The cause was heater-cathode leakage. The 60-cycle hum voltage was being directly impressed on the plate supply voltage for the video if and video amplifier tubes.

So, when servicing any modern set, if the symptoms don't seem to agree with your tentative diagnosis, get out the schematic and look for a stacked-B circuit hiding somewhere.

Since the tubes not only control the amount of amplification, but also determine the operating constants of several stages besides their own, their condition becomes very important. So when troubleshooting, test *all* tubes first. This means not only the power tube in the upper half, but all tubes connected to the 150-volt line on the lower half too. Heater-cathode shorts, leakage, gas or interelectrode leakage can really play hob with voltage distribution in such circuits!

After this primary test, check the B-plus supply voltage. If it isn't within 5% of the value called for in the service data, find out why and get it back to normal before going further.

### Low voltage

If an unexplainable low-voltage condition is found, break the B-plus circuit, and insert a milliammeter to read the total supply current. While this value is never given in service data (although it ought to be), it can be checked pretty closely. For example, if the set uses 500-ma selenium rectifiers, and you read a total current of 490 ma, something's wrong somewhere. There should be at least 100 ma of reserve capacity for semiconductor rectifiers, and an equivalent amount for tubes.

A few checks on sets as they pass through the shop will enable you to make up a table of average current drain for the various types. You might even take this reading on each set, and note it right on the service data. In a lot of sets, it can be read quite easily; just lift the B-plus fuse and hook up a milliammeter in its place to get a quick reading.

Once tubes and supply voltages test OK, the serious checking can begin! Probably the best way to check a stacked-B stage is to measure plate and cathode voltages over the whole string. Although signal voltages are important, dc operating potentials are even more so. Unless they are correct, we have no chance of getting our signals through the stages with anything like the correct amplification. So check 'em out like a string of diodes. Compare the measured voltages with those shown in the service data. Any discrepancy must be located and corrected. If the initial plate-

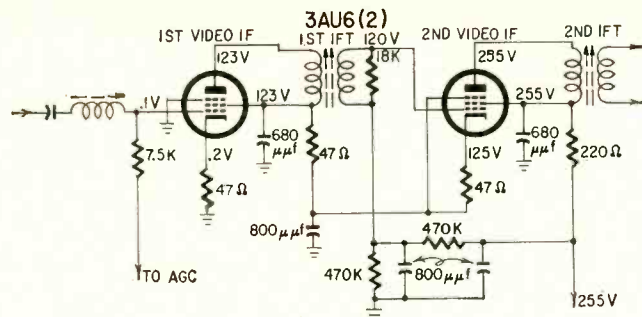

Fig. 3 — Stacked-B arrangement used in the if strip.

cathode voltage checks show trouble, measure control- and screen-grid voltages.

Components are very important in such stages, because of the divider action. Look closely at the circuits in the illustrations. You'll see that resistors play an important part in the voltage distribution, feeding operating potentials to grids, cathodes, etc. For ex-

proper filtering and bypassing of that lower half. Notice the 6W6 cathode circuit (the 150-volt source). Right on the cathode is a whopping 100- $\mu$ F electrolytic which, just for luck, is bypassed with a 680- $\mu$ F ceramic. Following the 150-ohm filter resistor, there is the output capacitor, the 40- $\mu$ F unit shunted by a 15,000-ohm resistor, to help stabilize the 150-volt line. This filter is the

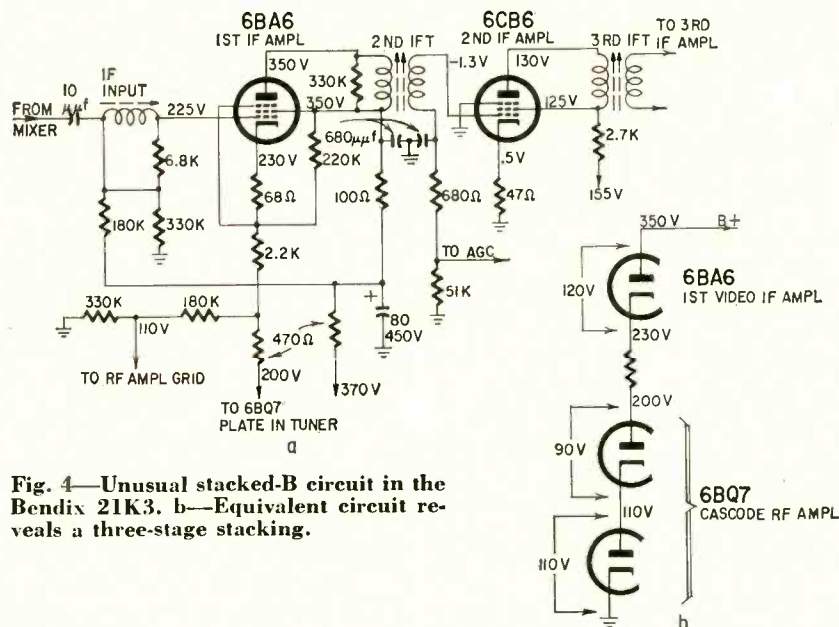

Fig. 4—Unusual stacked-B circuit in the Bendix 21K3. b—Equivalent circuit reveals a three-stage stacking.

ample, look at the voltage-divider network in the grid circuit of the 6BA6 in the Bendix of Fig. 4. Although it is in the grid circuit, it returns to the 370-volt supply! As you can plainly see, any shifting of values in this network and you've got trouble.

Capacitors used in these circuits must have practically no dc leakage at all. Because of the wide range of voltages encountered, only high-grade capacitors are suitable. You may find a capacitor connected between a -50 and a +375-volt source. Obviously, a 200- or 400-volt type isn't going to stay around too long here! While we're used to thinking of coupling capacitors in grid circuits as being the most critical, you'll find that excessive leakage in a capacitor *anywhere* in this circuit can cause trouble! So if an inexplicable unbalance is found in any stacked circuit, start checking capacitors.

Fig. 6 illustrates two points: first, the number of stages you may find hanging on the bottom half of a stacked-B circuit, and, second, the importance of

familiar  $\pi$ -section used in all power supplies. It must remove, not only all 60-cycle ripple still present, but also all audio, video, sync, vertical and horizontal pulses which might be floating around!

Therefore, if some sort of unusual trouble shows up, grab the scope and

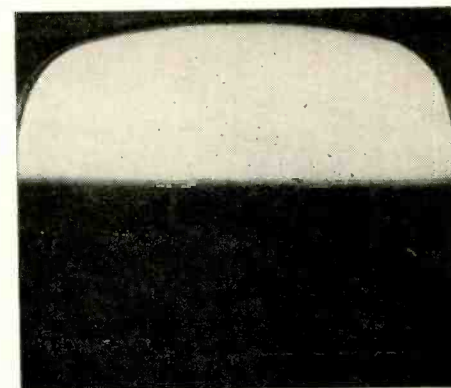
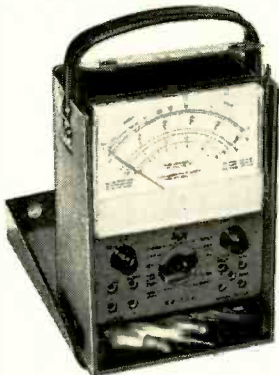

Fig. 5—Severe 60-cycle hum cause by heater-cathode leakage. Guess where?

# RCA ELECTRONIC INSTRUMENTS

## "PREFERRED BY PROFESSIONALS"

### METERS and TUBE TESTERS



#### WV-38A VOLT-OHM-MILLIAMMETER THE V-O-M WITH THE EXTRAS!

Compare this superlative RCA V-O-M against the model you may have been thinking of buying. See if it doesn't check out better in these extra features:

- EXTRA! 1.0 volt and 0.25 volt ranges DC!
- EXTRA! Big easy-to-read 5 1/4" meter!
- EXTRA! Non-breakable plastic case; no glass to crack or shatter!
- EXTRA! Smart attractive modern styling—the V-O-M of the future!
- EXTRA! Red test lead has probe and slip-on alligator clip for added versatility!
- EXTRA! Orderly location of jacks below switches keeps leads out of the way!
- EXTRA! Spring clips on handle to hold test leads!

- EXTRA! DB scales clearly marked: no squinting!
- EXTRA! Rugged, scuff-proof, stain-resistant laminated vinyl carrying case, only \$4.95\* extra!

Only \$43.95\* complete with batteries, instruction book and all probes, clips and cables. (RCA V-O-M Kit only \$29.95\*.)



#### NEW! WV-77E VOLTOHMYST®

Measures AC and DC voltages to 1500 volts; resistance from 0.2 ohm to 1,000 megohms. Separate scales, 1 1/2 volts rms and 4 volts peak-to-peak for low AC measurements.

Only \$43.95\* complete with probes, leads, instructions. (RCA VoltOhmyst Kit only \$29.95\*.)



#### NEW! WV-98B SENIOR VOLTOHMYST®

Measures AC and DC voltages (3% accuracy); resistance from 0 to 1,000 megohms. Measures peak-to-peak values of complex waveforms. Rugged cast aluminum case, big 6 1/2" meter. Only \$79.50\* with leads, clips, instructions. Also available in economical kit form.



#### WT-110A AUTOMATIC ELECTRON TUBE TESTER

Especially designed for TV and general service testing of electron tubes. Uses automatic punched-card selection of correct test conditions on wide variety of tubes. Checks vacuum-tube rectifiers under high-current conditions. \$199.50\* complete with 263 punched cards, 24 blank cards, card punch; instruction book.

### SCOPES



#### WO-91A<sup>\*</sup> 5-INCH COLOR-TV OSCILLOSCOPE

High-performance, wide-band oscilloscope ideally suited for color-TV, black-and-white TV, and other electronic applications. Dual bandwidth (4.5 Mc, 0.053 volts rms/in. and 1.5 Mc, 0.018 volts rms/in.). Internal calibrating voltage and calibrated graph screen. Includes special direct/low-cap shielded probe and cable.

Only \$239.50\* complete with ground cable, insulated clip, instruction book.



#### NEW! WO-33A SUPER-PORTABLE OSCILLOSCOPE

A low-cost all-purpose scope you can carry anywhere—only 14 pounds—ideal for in-the-home servicing of black-and-white and color-TV, audio and ultrasonic equipment. High gain and wide bandwidth to handle the tough jobs! Rugged and compact—scaled 3" graph screen.

Only \$129.95\* complete with low-cap direct input probe, cable, power cord, cord-carrying brackets, instructions. (RCA Super-Portable Oscilloscope Kit, only \$79.95\*.)

### GENERATORS



#### NEW! WA-44C AUDIO GENERATOR

Generates sine and square wave signals for testing audio systems. Frequency range: 20 cps to 200 Kc. Used to measure intermodulation distortion, frequency response, input and output impedances, speaker resonance, speed of recording and playback mechanisms, transient response and phase shift. Only \$98.50\* with cable and instructions.



#### WR-69A TELEVISION/FM SWEEP GENERATOR

For visual alignment and troubleshooting of TV rf/lf/vf circuits and other electronic equipment. IF/video frequency ranges 50 Kc to 50 Mc, TV channels 2 to 13, plus FM range—88-108 Mc. Sweep width continuously adjustable to 12 Mc or more. Only \$295.00\* with cables, instruction book.



#### WR-99A CRYSTAL- CALIBRATED MARKER GENERATOR

To supply a fundamental frequency rf carrier of crystal accuracy for aligning and troubleshooting color-TV, black-and-white TV, FM receivers and other electronic equipment operating in 19 Mc to 260 Mc range. Only \$242.50\* complete with output cable, two phone tips, instruction book.



#### WR-49B SIGNAL GENERATOR

For alignment and signal tracing of AM/FM receivers, low-frequency signal tracing and alignment of TV vf/lf amplifiers. Six ranges—85 Kc to 30 Mc. Internal 400 cps modulation. Low rf signal leakage! Only \$79.50\* complete with shielded cable for rf and af output, instruction book.



#### WR-70A RF/IF/VF MARKER ADDER

To be used with WR-69A or similar electronic equipment. Eliminates waveform distortion due to receiver overloading during visual alignment by adding markers after the rf signal is demodulated. Only \$74.50\* with cables, instruction book.

There's an RCA test instrument to help you do every job better, and easier—and to save you valuable time. A comprehensive line of test accessories: video multi-markers, TV isotaps and bias supplies, probes and cables. See your Authorized RCA Electronic Instrument Distributor for complete information.

RCA Electron Tube Division, Harrison, N.J.

\*User Price (Optional)



The Most Trusted Name in Electronics  
RADIO CORPORATION OF AMERICA

# Columbia

## SUPER-FLEX

Ultra Flexible Coaxial Cable

- EXTRA FLEXIBLE CONDUCTOR
- EXTRA FLEXIBLE JACKET
- EXTRA LOW COST

NEW! Super-flexible 52 ohm and 72 ohm Coaxial Cable for Citizens' Band and Multiple Television Systems, etc. Cable jackets are high gloss super-smooth, non-contaminating FLEXLIFE Vinyl that will not become rigid in cold weather. Another First from COLUMBIA.

### SUPER-FLEX RG 58A/U

Center Conductor: 19/.0068 Tinned Copper. Jacket: Columbia Black Flexlife Insulation. Dielectric: Low loss Foam Polyethylene.



### SUPER-FLEX RG 8/U

Center Conductor: 19/24 Soft Copper. Jacket: Columbia Black Flexlife Insulation. Dielectric: Low loss Foam Polyethylene.



### SUPER-FLEX RG 59/U

Center Conductor: 7/31 Soft Copper. Jacket: Columbia Silver Grey Flexlife Insulation. Dielectric: Low loss Foam Polyethylene.



Available thru your local distributor



**WIRE & SUPPLY CO.**  
2850 IRVING PARK ROAD  
CHICAGO 18, ILLINOIS

"America's Most Complete Wire Line"

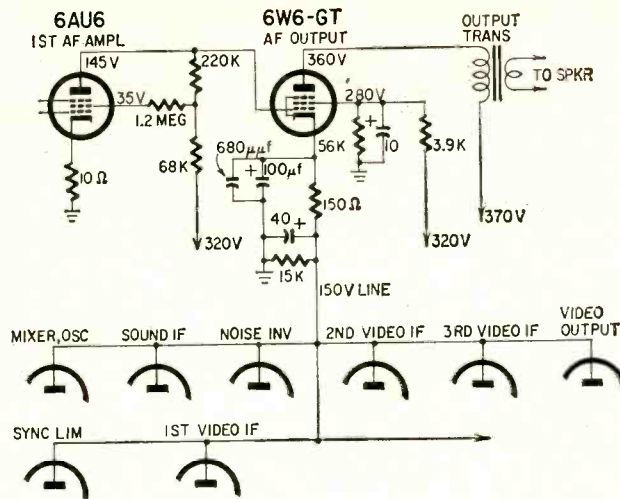

Fig. 6—Eight tubes on the lower half of this stacked-B circuit.

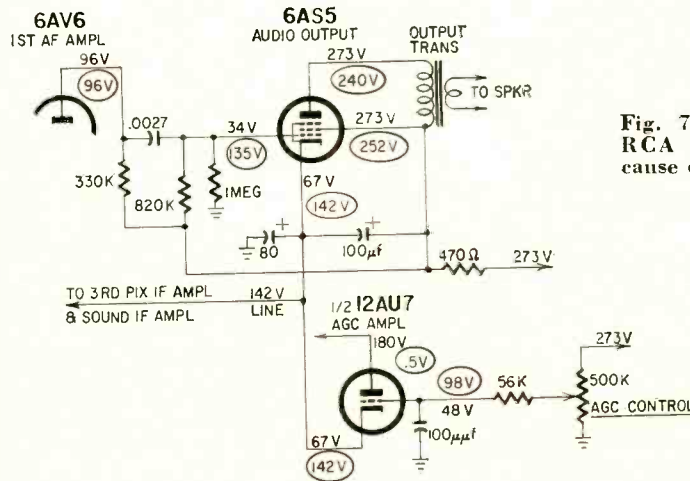

Fig. 7—Partial circuit of RCA KCS-92 showing cause of age trouble.

check this 150-volt line for signs of excessive ripple at all possible frequencies.

### Interaction of stages

Finally, watch out for troubles which may appear to be in one stage but actually are somewhere else! Such electronic mirages are quite common in the typical stacked-B circuit.

A good example of this was an RCA KCS-92 chassis which came in with a very obvious case of age trouble. All the standard symptoms were there: complete whiteout of the screen, excessive age voltage and so on. There was only one wee problem—the agc circuit was OK! Fig. 7 shows the parts of the circuit actually involved in the trouble. The voltages at the tube elements are those actually measured during the trouble—the circled ones are the right voltages. Now, before you go any further, can you spot the trouble?

The key clues here are the control-grid and plate and screen voltages on the 6AS5 audio output tube. Notice that plate and screen voltages are high and the grid is way off, only 67 instead of the normal 135 volts. The cathode is off, too, 67 instead of 142 volts. The suspect here, and I checked first, was the coupling capacitor between the 6AV6 plate and the 6AS5 grid. I could have

saved myself the trouble by reading the 6AV6 plate voltage more closely; it was still normal. The 1-megohm resistor to ground was also good. This left only one more and, sure enough, there it was. The 820,000-ohm resistor between the 6AS5 grid and the 273-volt line was "slightly" off—it measured something like 13 megohms! The loss of this bucking voltage, used to adjust the bias on the 6AS5, allowed the grid to go highly negative. The actual control grid voltage was -34 volts. This caused the tube to cut off. So, we were dropping 206 volts across the plate resistance of the 6AS5, instead of the 131 volts we should have had. This upset the 142-volt line, which changed the bias applied to grid and cathode of the agc tube and caused it to go phooie. A very high agc bias was applied to all controlled stages, and we got the whiteout.

So no matter what kind of symptoms you find in one of these sets, take a very close look at the schematic, and especially the dc voltage data. See if there isn't a stacked-B circuit in there somewhere. If there is, it may be causing your troubles in some such obscure way! Always be alert for such interlocking actions, and you'll not only save a lot of time, but lots of money previously blown on aspirin!

END

# CROSSOVER NETWORK?

YES but designed  
with a  
**NEW IDEA**  
in mind



You'll find it—and  
lots of other  
**NEW IDEAS**

IN NEXT MONTH'S

# Radio-Electronics

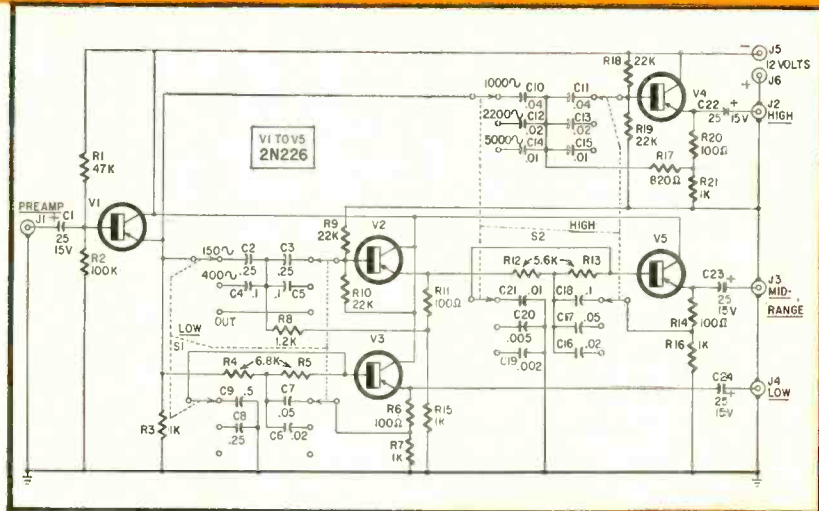

## 3-WAY ELECTRONIC CROSSOVER Uses Active Elements

A little imagination has put transistors to work as active elements to add gain and neutralize attenuation. Remember Daniel Meyer, designer of the transistor hi-fi amplifier (October 1959) and transistor preamp (December, 1960)? This is another of his **NEW IDEAS**.

## SERVICING WIRELESS INTERCOMS

Seems everybody is using intercoms today—in homes, offices, schools, industrial plants. This article brings you up to date on servicing techniques for wireless types.

## THE STORY OF RELAYS

Relays are doing a job in industry. Here's the start of a comprehensive series that takes a look at them in action—how and where they're used, how to troubleshoot and service them.

## NEW KITS TEACH ELECTRONICS

Kits, long a reliable and bug-free standby with technician and experimenter, have gone to school. Here's a review of some of the newest and most interesting: a code oscillator and a basic kit for teaching fundamentals, transistor radio and light control relays for the more advanced, and an analog computer that teaches electronics in universities—plus many others that help educate science students at varying levels.

## IMPROVED CAPACITANCE METER

Two transistors in a multivibrator circuit make this instrument portable and ready for instant use. This one is simple to build and easy to calibrate. Measures values from 5  $\mu\text{f}$  to .001  $\mu\text{f}$ .

**PLUS**—loads and loads of other **NEW IDEAS** on servicing, test instruments, industrial electronics, high fidelity and electronics.

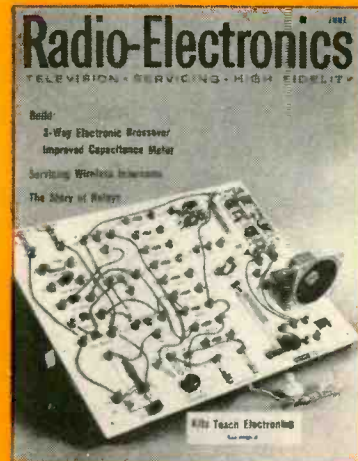

Don't Miss  
**Radio-Electronics**  
June Issue  
on Sale May 16  
**50c**

## SUBSCRIPTION RATES

3 years	\$12
2 years	\$ 9
1 year	\$ 5

154 West 14th St., New York 11, N. Y.

# CRYSTAL BEATNIK OSCILLATOR

*An unusual signal generator or calibrator that uses three crystal-controlled transistor oscillators to develop spot frequencies ranging from a few kc to well above 50 mc.*

**A** CRYSTAL oscillator is the simplest and most accurate device for generating precise rf signals. A few inexpensive parts—a crystal, a transistor and a battery—make a complete and useful oscillator (see page 82, January 1960). However, the crystal oscillator has one disadvantage. It is limited to a single fundamental frequency. You need as many crystals as fundamentals.

The number of frequencies per crystal can be increased if you use a pair of oscillators coupled by a diode mixer. The two oscillators then generate beats that extend over a wide spectrum. The beats are especially useful when the crystals are ground for convenient frequencies such as 5000, and 7500 kc, and when the frequency difference between them is a convenient 100 or 500 cycles. However, any pair of crystals between

about 3 to 9 mc seems to work in this "beatnik." Of course, all the beats are crystal-controlled.

Here is an example. Assume that 7000- and 7050-kc crystals are used. Beats will occur at 50-kc intervals that originate at the fundamentals. An all-wave receiver will tune in signals at 7100, 7150 and 7200 kc and so on, as well as both fundamentals. Similarly, there will be beats at 6950, 6900, 6850 kc, etc. The beats are strongest near the fundamental frequencies. These show up well on the S-meter of a receiver. Weaker ones can be detected with the aid of a local bfo.

Harmonics are always present so there will be crystal-controlled output at 14,000 and 14,100 kc also, when using the above crystal pair. Thanks to the beatnik, however, many more crystal-controlled markers are available. As before, beats appear at 50-kc intervals above 14,100 kc and below 14,000 kc, as well as at 14,050.

When the interval between beat frequencies is small compared with the fundamentals, the amplitude of the beats decays and dead spots may appear between successive harmonic groups. Fig. 1 shows a typical spectrum (not drawn to scale). A and B are the crystal fundamentals; each accompanied by a train of beats which decay in amplitude. The harmonics, 2A and 2B, are also centers of beat clusters. If there is a wide interval between any two beat frequencies, the beats remain strong until reinforced by the various harmonics.

If the crystal pair consists of 7000- and 7500-kc crystals, for example, the interval (500 kc) is relatively large. The result is continuous coverage of the entire spectrum with 500-kc markers. With 5000- and 5500-kc crystals, the coverage is still better. The amplitude of the beats remains constant and strong beyond 50 mc and down to the broadcast band!

A combination of 5000- and 7500-kc crystals results in beats at every multiple of 2.5 mc as expected. Strangely enough, each is *tone-modulated*. This may be explained as follows. No crystal is exactly on frequency, so the 7.5-mc crystal may actually be 7.501 mc. When this beats with the 5-mc crystal, we get a 2.501-mc signal. However, when the 7.501-mc crystal beats with the 10-mc second harmonic of the 5-mc crystal, we get 2.499-mc signal. The 2,000-cycle difference between 2.501 mc and 2.499 mc provides the audio signal. The exact frequency of the tone depends upon the actual crystal frequencies, not their marked values.

With a 5000-kc and 7000-kc crystal combination one might expect only odd integral megacycles. Actually, there is an output at every integral megacycle, giving the equivalent of a 1-mc oscillator, except that the beatnik output seems much greater, even at 55 mc.

The beatnik may be used with crystals differing only slightly in frequency too. For example, 3575- and 3550-kc crystals permit calibrating a portion of the 80-meter band at intervals of



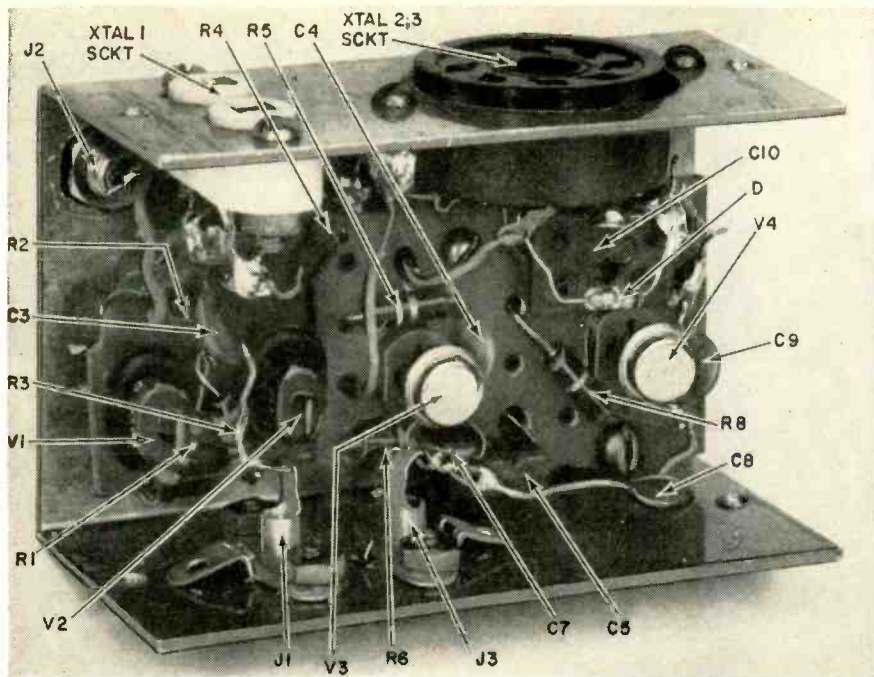

A look at the beatnik's innards.

only 25 kc. Such a pair would also calibrate higher harmonic bands.

You can also pair up crystals that are nearly in the ratio of some small number. For example, 4300 and 7600 are nearly in the ratio of 2 to 1. The second harmonic of 4300 is 8600, which is exactly 1 mc from the other crystal, so we get markers at 1-mc intervals. This actually occurs at integral mc points. In addition, the 1 mc beats with 8600 kc to produce beats ending in 0.6 mc, such as 9.6, 10.6, 11.6, etc. Furthermore, beats are generated at 3.3, 2.3, 1.3 mc, etc. If these markers are correctly interpreted, you will have numerous points to calibrate and compare with other frequencies.

In every case, the precision of your beats depends upon the precision of the crystal. Crystals selling for as little as 49c are usually accurate enough for most purposes. Many stores are still selling Signal Corps rf crystals at low prices.

Several manufacturers grind crystals to any specified frequency at a reasonable price. A 5000-kc crystal is a handy value for the beatnik.

The beatnik circuit for generating beats with a pair of crystals has been combined in the same box with a two-transistor generator which takes crystals in the 400-500-kc range. It was described in the November 1956, issue of RADIO-ELECTRONICS, page 37, Fig. 4. Both circuits are shown in Fig. 2.

The dual instrument uses an external 6-volt power supply. There are separate power and output jacks for each oscillator. Use the proper power and output jack for the desired band (low frequency or high).

For low frequencies, a two-lead conductor connects the beatnik to a receiver antenna and ground for maximum signal. The beatnik chassis corresponds to ground. For high frequencies, the

ground loads the beatnik too much and should be eliminated. Use only a connection from the beatnik to the receiver antenna for a strong high-frequency signal.

Each oscillator is assembled onto separate plastic subchassis which are mounted inside a 3 x 2 x 1½-inch metal box.

- R1—3,900 ohms
- R2—1,800 ohms
- R3—4,700 ohms
- R4—15,000 ohms
- R5, R7—120,000 ohms
- R6, R8—1,000 ohms
- All resistors ½-watt 10%
- C1, C2, C6—.005 µf, ceramic
- C3, C7—.001 µf, ceramic
- C4, C9—12 µf, ceramic
- C5, C10—56 µf, ceramic
- C8—220 µf, ceramic
- D—IN34
- J1, J2, J3, J4—phono jacks
- V1—2N169
- V2—2N170
- V3, V4—2N503
- XTAL 1, XTAL 2, XTAL 3—selected for desired frequency
- Case—3 x 2 x 1½ inches
- Miscellaneous hardware

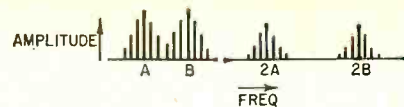

Fig. 1—Typical spectrum of crystal markers obtained with the crystal beatnik oscillator.

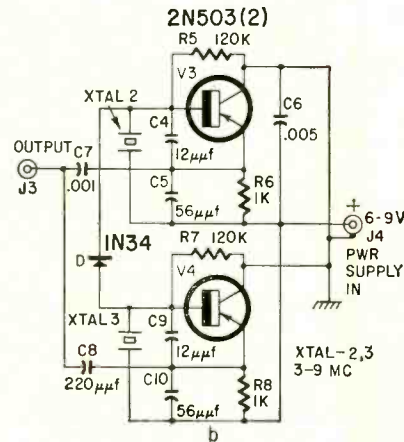
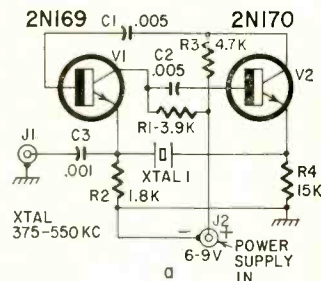
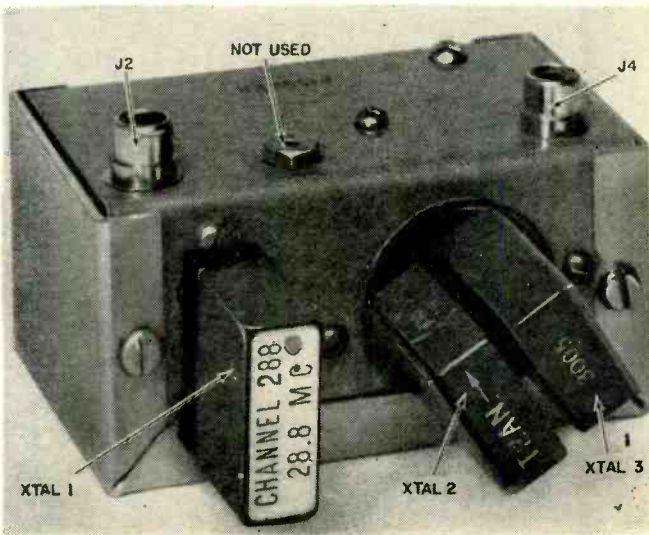

Fig. 2—Circuit of the oscillator. High-frequency and low-frequency sections are shown separately.

Three crystals plug into the beatnik.



# Basic servicing tricks

*These radio hints and techniques are all "old stuff" but you'd be surprised how new most of them are to the apprentice in your shop.*

**T**HE service technician just out of training runs into many jobs he can't seem to solve. He just hasn't the feel of things yet and needs a little practice. So let's take a common ac-dc receiver and go through the common troubles.

In many ac-dc radios, the heaters are in series. An intermittent heater in such a set can be hard to find but doesn't have to be. Simply pull the chassis from the cabinet and, taking one tube socket at a time, bridge a small neon lamp or a 6-watt 110-volt lamp across the heaters (Fig. 1). If the lamp lights the next time the heaters wink out, you have the lamp connected across the bad tube. Oftentimes an ac voltmeter will show up the abnormal filament even while it is operating. If voltage across one heater is much higher or lower than across others of the same rating, suspect that tube.

If several tubes light extra bright while one or more others don't light at all, look for a heater-cathode short. A tube tester will usually reveal this fault. If not, tube substitution will.

Next most frequent trouble seems to be bias trouble in the audio output stage because of a shorted tube or coupling capacitor. If the output tube has a cathode resistor, check grid voltage between grid and ground. Hook up your voltmeter and momentarily pull the tube. If you don't get a positive voltage indication, the tube is presumably at fault. If you do get a positive indication, clip off the coupling capacitor at the grid and double-check by connecting the voltmeter from the clipped end of the capacitor to ground (Fig. 2). In the rare case it could be leakage in the socket.

If the tube has fixed bias (grid coupled to the negative power supply through a grid resistor or resistors), check coupling-capacitor leakage by placing the voltmeter's positive lead on the grid and the negative on the far end of the grid resistor (Fig. 3).

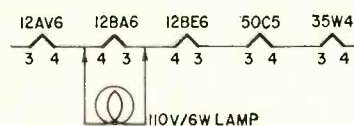

Fig. 1—A lamp across a filament will light if the filament is open.

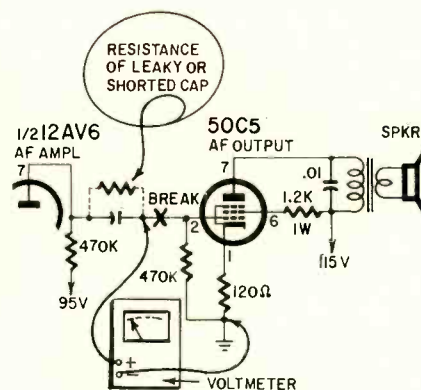

Fig. 2—Check for a leaky coupling capacitor in a cathode bias output stage.

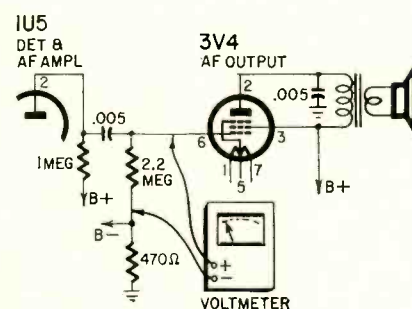

Fig. 3—Check for leaky coupling capacitor in a fixed bias stage. This type circuit is usually found in 3-way portables and is rarely seen in new sets.

Direct shorts are spotted by checking resistance from output-tube plate to ground and screen grid to ground. Also, note your resistance readings. A considerably lower reading on the plate than the screen indicates a short in the plate circuit (plate bypass or tone capacitor shorted) or rarely, a high-resistance output transformer primary. In some circuits, cutting various B-plus leads to isolate circuits makes the short simpler to find. Don't overlook the possibility of shorts in if and oscillator transformers.

## The grid-grounding technique

With the volume control turned up, touch each grid and plate with the tip of a screwdriver blade (insulated handle, of course). Start from the output tube and work your way back. This will make a loud noise in the speaker if the stage is good. This is a rough stage-by-stage check and isn't to be relied on 100%. If the oscillator transformer is open (grid to cathode), this test will cause a loud noise in the speaker, showing the rf grid section is hot. If the coil has a tickler winding for the plate, the oscillator's anode grid or plate will measure zero volts.

Another fault, especially where an open-end winding serves as coupling capacitor to the oscillator grid, is that oscillator won't fire. Clip the lead and install a 75- or 100- $\mu$ F mica capacitor from the tap going to the tuning gang to the oscillator's grid. To check shorts in the tuning gang, unhook the oscillator section (usually it is a few ohms to ground or B-minus). If in doubt, unhook the rf section too and check both sections of the tuning gang.

## Capacitor troubles

To find and burn out shorts, unhook the gang from the receiver. Then connect a 100-watt bulb in series with the line and connect each section of the gang in turn. As you rotate the gang, the bulb will light whenever the capaci-

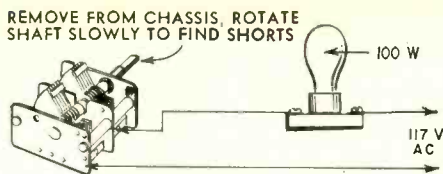

Fig. 4—Checking a tuning capacitor for shorts. Simple hook-up will burn out minor ones.

tor shorts and the line voltage will burn out minor shorts (Fig. 4). [Watch this one—you have dangerous line voltage all over the bench.—*Editor*]

Straighten tuning capacitor plates if they are touching. Don't forget to use a cleaner on the ends and a drop of oil in the bearings. Some gangs are insulated from chassis and are tied back to avc. Be sure the capacitor isn't shorting to chassis and grounding the avc.

Check avc with a vtvm. If locals are distorted and distant stations are clear, shunt the avc filter resistor with a 2- or 3-megohm resistor and the avc load with a 0.5- to 1-megohm resistor (the volume control is often the load resistor in small sets, but not always). If this clears up the trouble, check each resistor with an ohmmeter (isolating one end). Also, check the avc bypass capacitor for leakage or, better, replace them outright. (Even several megs leakage can cause trouble here.) An rf, mixer or if tube can cause avc trouble if it is leaky or gassy.

Bridging filter capacitors with a good one will show up bad filters. Sometimes the leakage is between sections of a multiple-section capacitor. In this case, clip out one section and connect a good capacitor in its place. In rare cases (nowadays anyway) leakage between the capacitor case and ground causes bad hum. On sets that use voltage doublers, connect a voltmeter across capacitor to find the faulty one.

This also applies to printed-circuit sets, though they may be harder to work on. Use a sharp knife or razor blade to cut and isolate circuits. You can solder the breaks later.

On car radios, pulling and inserting a tube quickly will pinpoint the dead stage. It is best to replace the buffer capacitor when replacing a vibrator, but remember your customer may not want to spend that much. Check current drain as shown in Fig. 5. If the current is two-thirds or less of fuse rating, you can probably take a chance. If current is higher, check the buffer and the power transformer.

Also check for broken or melted bypass capacitors on the low-voltage A-circuits. They can cause vibrator hash.

If some of the tubes are lit and others are not, a broken connection in the heater line is the trouble. But if everything is dead and current is getting to the radio, check the on-off switch—it's a big offender.

#### Miscellaneous

An open electrolytic capacitor will usually make a radio motorboat or squeal. Be careful of coil leads; they are very fragile. In ac-dc battery sets, a 25-ma rectifier with leads—so it can

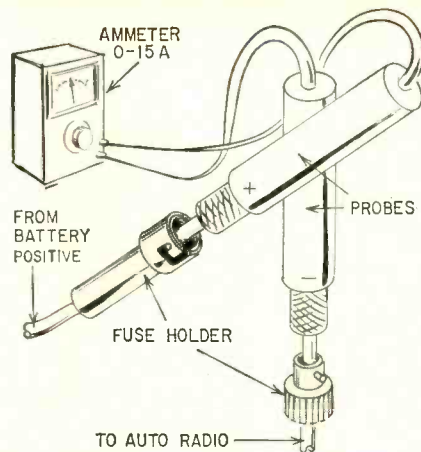

Fig. 5—When changing a vibrator, a quick check of current being drawn by the auto radio gives a rough idea as to the need for a new buffer capacitor.

be bridged across the rectifier in the set—is a handy gadget. In the rare cases where a new rectifier and filters and a check of the heater dropping resistor do not cure the trouble, take a 12,000-ohm 2-watt resistor and bridge the heater dropping resistor. Check with a voltmeter to see if this raises the voltage on the mixer heater to the proper value. If not, try 10,000 ohms.

Don't forget to inspect wires where they pass through chassis holes or bend around sharp corners or objects. This has caused lots of troubles in all makes of sets. Also don't overlook grounds connected to the chassis with a soldering lug or rivet. We have seen many troubles that others have given up on that turn out to be poor grounds.

#### Transistor radios

A signal tracer is a handy instrument and almost a must for transistor radios. A set of good schematics is a big help and a time saver. A good transistor checker is a must, too.

Checking voltages (resistance checks are almost useless due to transistor resistance) and also battery current drain (against the schematic) is a good beginning. Signal tracing from base to collector (sometimes the emitter in rf stages) will pinpoint the bad stage. A good instrument is a signal generator that emits rf and audio at the same time.

A broadly tuned stage (as the if slug is turned) is a good sign (but not always) that the transistor has high leakage. A normal transistor stage will be broader than a tube stage. A few experiments with good sets will show you what to expect.

Common sense, a little theory, a little circuit knowhow, proper instruments, diagrams, data and proper tools will fix any set. *Don't tear a set to pieces till you know what it is or is not doing*, and have a fair idea of where to start looking. One of the greatest offenders I've known was a young man who used to fill in Saturdays in a shop where I worked. He would tear the set completely apart and leave it. When I came in Monday, I usually found the fault didn't require dismantling, and had to put the set back together. END

# COLOR TV IS BRIGHT, SHARP, TRUE WHEN YOU PLUG-IN A WINEGARD WBC4-X SIGNAL BOOSTER

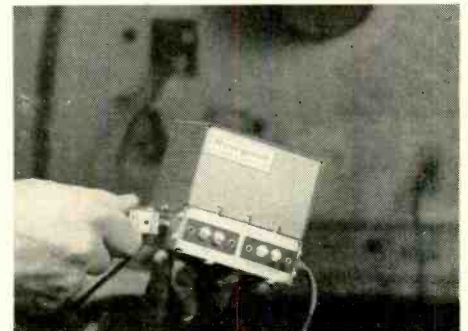

For *REALLY* good color reception, you need a strong signal. And you get it with a Winegard WBC-4X Signal Booster with up to 12.5 DB gain on all channels and flat frequency response. The WBC-4X has new ultra low noise 6DJ8 frame grid tube with AC isolation on BOTH filaments and plate—it's the only all AC Booster on the market—no "hot" chassis. Can also be used as a 4 set TV and FM amplified coupler.

Comes complete, ready to install—4 sets of no-strip terminals, on-off switch, antenna disconnect plug—only \$27.50 list. Ask your distributor or write for technical bulletin.



Everything from  
antenna to set

## Winegard

ANTENNA SYSTEMS  
301-5 Kirkwood, Burlington, Iowa

*Schober*  
 captures  
 magnificent  
 pipe organ  
 tone  
 in a  
 tiny  
 electronic  
 tube . . . . .

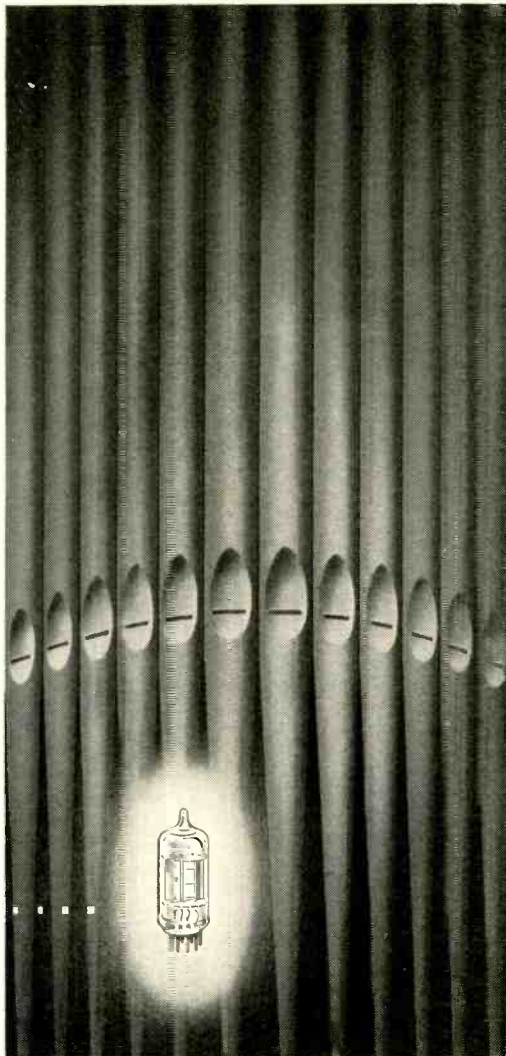

**H**ere is magnificent Pipe Organ tone; tremendous tonal color range; two 61-note pipe-organ keyboards; hand-rubbed cabinetry in the finish of your choice. Taken together they comprise a superlative electronic instrument comparable to organs selling for \$2,500 to \$6,000.

Yet, when you assemble the Schober of your choice, you save more than half the normal cost and create a superb instrument to bring the delightful gift of music to your family.

Matched kits and printed circuitry make it possible.

Work requiring knowledge and experience is eliminated. All that remains is the pride and pleasure of watching a fine musical instrument take shape under your own hands. The Schober organ you assemble will equal or surpass any factory-built organ for quality, reliability and circuitry.

And the Schober Electronic Organ is so easy to play!

From the very first day even novices will transform simple tunes into deeply satisfying musical experiences — because unlike a piano whose tone dies away almost as soon as the keys are struck, organ tones continue to sing out as long as the key is held down. Then, by simply moving your right foot, you change the volume so that the sound becomes rich and alive.

The coupon brings you full details on how you can start building the Schober of your choice with an investment of as little as \$18.95. In addition, you may have an exciting 10" LP record demonstrating Schober's full range of tones and voices. The \$2 charge for the record is refunded when you order your starting kit. No salesman will call.

**MAIL THIS COUPON TODAY**

**THE Schober Organ CORPORATION**  
 Dept. RE-11, 43 WEST 61ST STREET, NEW YORK 23, N.Y.

The Schober Organ Corp., Dept. RE-11  
 43 West 61st Street, New York 23, N.Y.

- Please send me FREE full-color booklet and other literature on the Schober organ.
- Please send me the Hi-Fi demonstration record. I enclose \$2 which is refundable when I order my first kit.

name \_\_\_\_\_  
 address \_\_\_\_\_  
 city \_\_\_\_\_ zone \_\_\_\_\_ state \_\_\_\_\_

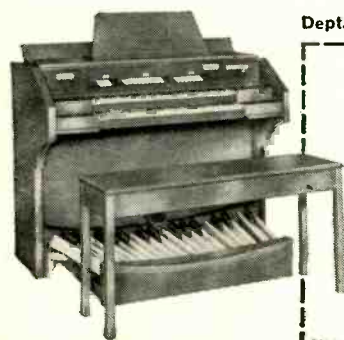

Hushpuppy in speaker circuit.

## Hushpuppy for squelch

**W**E were attracted recently by an ad that started "What Price Standby Silence?" and offered the above-named device at \$4.95 ("list price \$9.95") as a squelch device for Citizens-band radio receivers. We sent for one.

The Hushpuppy was a strange-looking device intended to be attached at the speaker terminals. Much clipping away of plaster-of-paris revealed the works: two pilot lamps, two 4.7-ohm resistors and a terminal strip.

A look at it shows a variation on a very old volume-expansion circuit, described by de Rosa in the 1930's. The two 4.7-ohm resistors and the two pilot lamps form a bridge fed by the output transformer, with the voice coil across

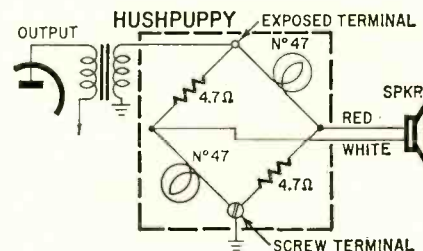

Hushpuppy mounted at speaker.

it. At no signal or with small signals, the lamp filaments remain cold and, since their resistance is in the same order as that of the resistors, the bridge is near balance and little if any signal goes through the speaker voice coil, both ends of the voice coil remaining at the same voltage while current passes through the resistors and lamps in parallel. With stronger signals, the lamp filaments heat up and their impedance increases to a considerably higher value than that of the fixed resistors. The bridge is unbalanced and current flows through the series resistors and the voice coil.

Unfortunately, it takes a considerably higher setting of the volume control to get the same output when the Hushpuppy is used. Both weak stations and noise are squelched together. **END**

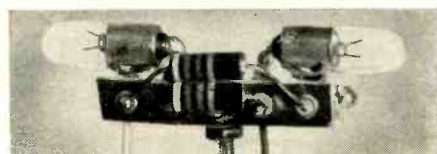

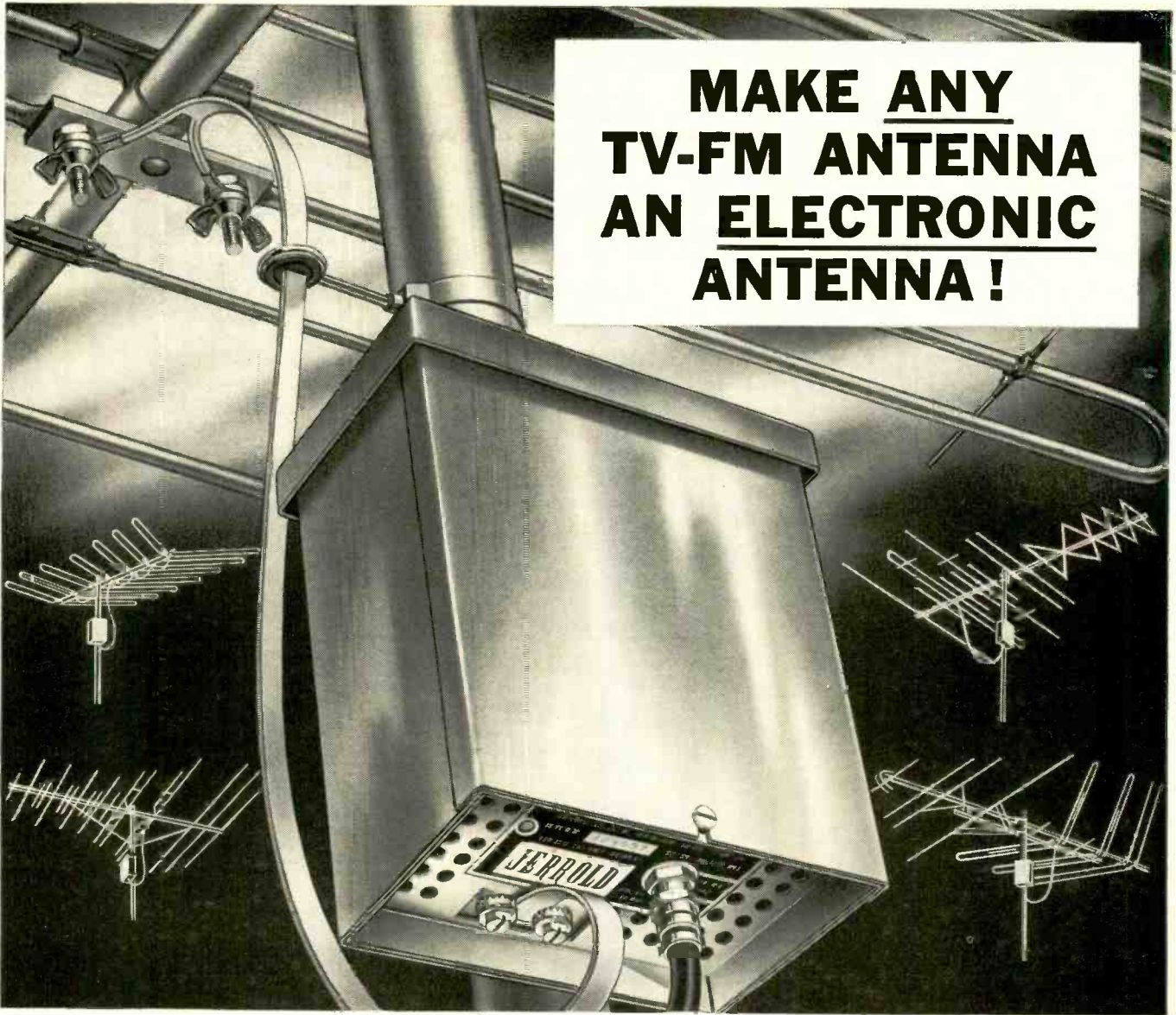

**MAKE ANY  
TV-FM ANTENNA  
AN ELECTRONIC  
ANTENNA!**

## **New Jerrold DE-SNOWER<sup>®</sup> Model 202 Increases Gain of Any Antenna **10 TIMES!****

Out of the Jerrold laboratories, where the famous DSA-132 was born, comes the ultimate in signal preamplifiers for all channel TV (VHF) and FM reception. By combining *two* frame grid 6DJ8 dual triodes in a special low noise circuit, Jerrold's new DSA-202 develops *minimum* 20 db gain (10 times) on all TV channels and 8db (min.) on FM . . . *triple* the gain developed when using one 6DJ8. Also featured is a new lightweight iridite-aluminum weather-proof housing; no-strip twin lead terminals; and sliding access panel. All new high output remote power supply reduces a 117v AC to a safe 22 volts which goes up same cable that amplified signal comes down.

Only Jerrold assures you of proven reliability and unequaled performance based on more than a decade of designing and producing mast mounted preamplifiers . . . more Jerrold De-Snowers are in use today than all other makes combined.

See your Jerrold distributor or write for eight page booklet No. 435-286



**ELECTRONICS CORPORATION** • Distributor Sales Division  
Dept. IDS-138, Philadelphia 32, Pa.

Jerrold Electronics (Canada) Ltd., Toronto  
Export Representative: CBS International, New York 22, N.Y.

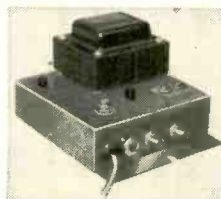

Includes new power supply model 407-P. Has "on-off" switch and handy cable compensating control.



Output uses shielded coax. to eliminate antenna feed-back and interference pick-up on down-lead.

Two 6DJ8 tubes develop 20 db gain (minimum) on all TV (VHF) and FM channels.

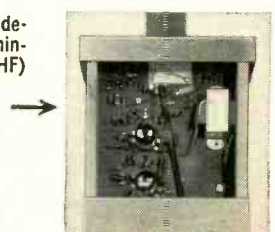

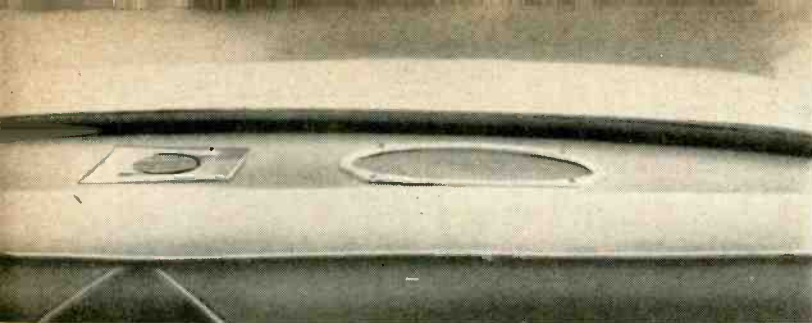

The completed system.



Arrangement inside trunk looks like this.

# Install a wide-range speaker system in your car

By **STEPHEN A. KALLIS, JR.**

**P**ITY the poor audiophile who owns a car, especially if he has to take long trips. Accustomed to high-quality music, he finds the output of the family buggy's radio is usually far below his standards. Eventually, the substandard sound will probably get the best of him, and he'll decide to do something about it. Said something may be an FM tuner or something even more exotic, depending on his skill and fanaticism.

No matter what he decides to do, however, he will need an adequate speaker system to enhance the result. Whatever design features Detroit puts into cars, audio engineering is not included, so it becomes very difficult to fit anything into a car. For example, while it would be nice to feed audio through a 15-inch coaxial or triaxial speaker, it is almost impossible to find a place to install such a speaker especially if you expect to fit passengers in as well. Thus we are forced to use a system which will fit within the limits Detroit imposes on us.

The speaker system described here is specifically designed for automobiles, and primarily as a foundation for a mobile high-fidelity system. In addition, it can be connected to the car radio for better AM sound until you get your other mobile high-fidelity components.

Speaker locations are pretty well predetermined. The only place they can be placed is in the rear-deck area. Some provisions have already been made in most modern cars for a speaker there, but these are inadequate.

The size of the woofer is also predetermined. The largest speaker that can be employed with this design is a

6 x 9-inch oval. A 3-inch tweeter completes the speaker complement. For the best response, the enclosure should be a base-reflex type. Cars have provision for 6 x 9 speakers, but do not lend themselves to reflex design so we used a modified arrangement somewhat similar to the R-J and Lafayette's Eliptoflex systems. The speaker is on a baffle board set back from the deck. The area described by the perimeter of the two woofer holes (the one in the deck and the one in the baffle board) and the space between them determines the port area. For this reason, the two holes should be the same size—the maximum inside size of the speaker. The board is set back 1 inch, fiber washers being used as spacers (see Fig. 1).

## The mechanical work

The simplest method of obtaining the correct-size elliptical holes is to use the grille plate as a guide. Simply trace the correct oval, using the inside of the grille rim as a template.

The baffle board itself should have certain features. It should measure at least 9 x 14 inches. The speaker is mounted in the center. Use 3/4-inch plywood for the baffle (Fig. 2).

The grille is very important. Many radio supply houses supply grilles, but most of them are unacceptable. The proper grille consists of an elliptical metal rim and a piece of porous fabric. A metallic grille or one covered with fancy metalwork may look prettier, but it hampers proper sound radiation by cutting down the effective port area. When buying a grille, make sure the fabric is porous. If it is not, make sure you get a grille with a separate frame, as you will have to buy grille cloth for it separately.

The tweeter is mounted flush with the deck, as it needs no reflex design. Any 3-inch PM speaker will do as long as it has the same impedance as the woofer (both should be 3.2 ohms). It is connected in parallel through a simple capacitance crossover consisting of a 10- $\mu$ f capacitor. (If you can obtain only electrolytic capacitors, buy two 20- $\mu$ f units and connect them back to back as in Fig. 3.) The two speakers should be phased beforehand.

Wiring is simple. Car manufacturers take advantage of the fact that a car has a metal chassis and ground one of the two audio leads. So only a single lead has to be run, and the other post of the speaker grounded. Depending on your choice, you can either use a three-position switch or a fader control for balancing the sound between your front (original) and rear speakers. If you plan to use an amplifying system other than the one for your car radio, add a spdt switch between the audio output and the fader or speaker switch (S in Fig. 3).

The rear-deck reflex makes a good weekend project. It can be the first step toward some excellent highway listening. And it makes the original car radio sound better! **END**

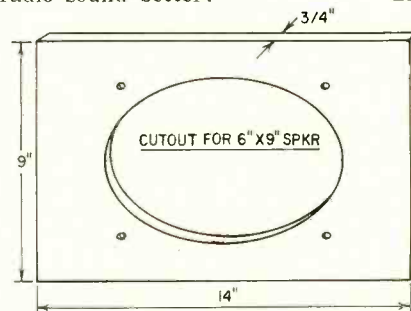

Fig. 2—Baffle-board dimensions. The minimum size in indicated.

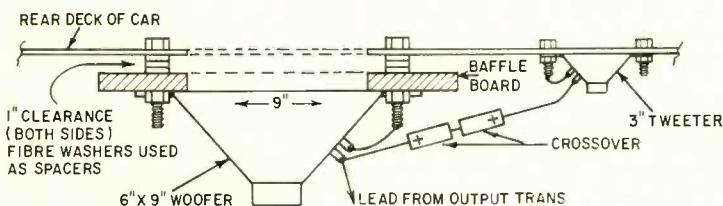

Fig. 1—Cross-section of speaker mounting and wiring.

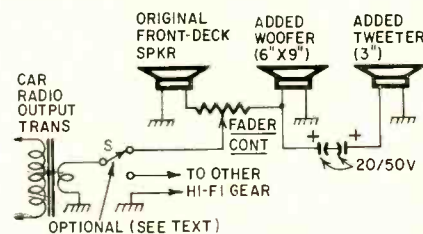

Fig. 3—Circuit of the improved speaker system.

*It's taking the country by storm*

THE MIGHTY MITE



**With thundering applause... here's what they say...**

- "It is the best tube tester I have ever owned."  
F. M., MONROE, LA., TV TECHNICIAN
- "It's a real asset to any serviceman." (35 years in servicing)  
C. H. W., EAST PRAIRIE, MO., TV TECHNICIAN
- "This is the best checker I have ever used."  
E. L. R., HASTINGS, MICH., TV TECHNICIAN
- "A must for every serviceman. A real Time Saver at a reasonable price."  
W. P., ERIE, PA., TV TECHNICIAN
- "The most complete and reliable instrument I ever bought for this price."  
H. P. R., QUEBEC, CANADA, TV TECHNICIAN
- "I already own one. This is my second Mighty Mite."  
PHILCO DISTRIBUTOR, ST. LOUIS, MO.
- "Mighty Mite has paid for itself the first month."  
W. C., UNIONTOWN, PA., TV REPAIR
- "I have found the Mighty Mite all that you say it is and more. It tests tubes that my other tester, costing twice as much, will not test."  
L. K. E., W9PWQ, CHICAGO, HAM

Don't be misled... there's only one Mighty Mite!

**MAGAZINE TEST LABS SAY...**

*PF Reporter, Nov., 1960, page 65...*  
"When putting the Model TC109 to work in the lab, I tried to 'trip up' the tester by throwing a few curves at it. Using my prized collection of rejected tubes that have mostly 'tough dog' defects, I proceeded with the tests given in the Sencore instructions." The results: The Mighty Mite found every trouble, even the toughest.

*Les Deane*

*Electronics World, Jan., 1961, page 103...*  
"We checked two dozen tubes known to be defective. Many had been passed as 'good' by other testers. Each failed at least one of the three tests provided by the TC109. On the other hand, every new tube previously known to be in good condition checked good on the Mighty Mite."

**In a nut shell...** here's why the Mighty Mite finds them all. It checks tube grid circuits with the same high sensitivity as the indispensable Sencore LC3 Leakage Checker; yet it checks emission, leakage and shorts just like the big, expensive testers. That's why we call it the Mighty Mite... you can't miss!

ONLY **59<sup>50</sup>**  
DEALER NET



Your Distributor

has them in stock



ALL PARTS MADE **SENCORE** IN AMERICA

**SENCORE**  
ADDISON 3, ILLINOIS

It's so easy to carry on every service call. The Mighty Mite is the smallest, most compact complete tester made. Smaller than a portable typewriter and with an all-steel case to protect it. Weighs less than 8 lbs.



## Lucky Hunts Low High Voltage

Lucky cures one trouble and introduces another. Net result, he learns a few things about horizontal oscillators.

By WAYNE LEMONS

Lucky was having trouble with a capital T—a Truetone TV with very little high voltage. In fact, it had just a slight reddish arc when you touched a screwdriver to the 1B3 plate cap. The set used a conventional phase detector, multivibrator, horizontal oscillator and sweep system. He had checked all the tubes and then, to be on the safe side, had replaced each one. Still there was not the slightest trace of high voltage at the picture-tube anode. He didn't trust test equipment too much and, as his employer had noted sourly on a few choice occasions, you couldn't trust the test equipment after he used it either! He decided, however, to check the grid drive on the 6BQ6. It seemed ample—21 volts negative. To him it meant that the horizontal oscillator was OK. He'd just have to look further.

Lucky checked the screen voltage on the 6BQ6; it was 145 volts. Nothing wrong there. He also measured the boost voltage; it was 320 volts. The B-plus was 290 volts. "Not near enough boost," he said, half aloud. He knew this was to be expected. He *had* learned long ago that a boost-voltage measurement didn't really tell him very much about *what* was wrong in the horizontal sweep system. About all it really told him was that something *was* wrong, an obvious fact of which he was already painfully aware.

He mumbled to himself, "Must be

the flyback or maybe the yoke." He remembered that he could substitute another yoke without actually mounting it, to see if the trouble was in the old yoke. He disconnected the horizontal leads from the yoke and, taking a new yoke with about the same inductance from stock, connected it in place of the set's yoke. He turned the brightness down to make sure he wouldn't burn the picture-tube phosphor if the high voltage came back on. He needn't have bothered. Seemed as though the arc on the 1B3 cap might be just a little bigger but he couldn't be certain.

"It just has to be the flyback!" he mumbled; he was just sure. He stole a glance to see if Cy—the shop owner—was watching. He had been "just sure" too many times before, only to get a lecture from Cy on finding the trouble *before* replacing all the parts in the circuit.

Lucky hesitated a moment and then decided that he better ask for a little help. He turned toward Cy and said half apologetically, "I got troubles, boss."

"That so?" asked Cy.

"This darn thing don't have any light on the screen—no high voltage."

"What have you done so far?"

Lucky told him.

"Sure the oscillator is OK?"

"Negative 21," replied Lucky.

"Means nothing," Cy said.

"What do you mean?"

"Well, the frequency could be way off and still there would be drive at the

grid of the horizontal output tube."

"You mean just because there is a drive voltage on the 6BQ6 doesn't mean the oscillator is all right?"

"Exactly. If the oscillator frequency is off, then there may not be enough efficiency in the high-voltage system to develop high voltage. Think what might happen if the oscillator is more than a couple of thousand cycles high or low."

"I get a little arc on the 1B3."

"I know, you told me, and that's partly why I suspect that the trouble might be in the oscillator. Of course, you could be right. It could be the flyback, but let's make some other checks first and see if we can't find out."

"Looks like with that little arc on the 1B3 cap that I should get a little high voltage on the picture tube," said Lucky.

"It would seem that way at first thought," returned Cy, "but remember that voltage for the 1B3 heater comes from a winding or two around the flyback. If the efficiency of the sweep system goes down, there might not be enough left to light the 1B3."

"And so no high voltage."

"Right."

"But how can we tell if the horizontal oscillator is off frequency or not?"

"Well, it isn't easy unless we have a special instrument," said Cy. "We might make a fair calculation using the scope, but that can be tricky."

"Any other way?"

"We could use a substitute oscillator, but we might find out easier."



# SPRAGUE CERAMIC CAPACITORS

## THE Complete LINE THAT OFFERS MORE THAN MERE "CAPACITY"

"Rated" capacitance is not enough . . . *actual* capacitance during operation is equally important. Excessively high or low values as well as capacitance change with temperature can foul up a TV or radio set. Therefore, characteristics such as Capacitance Stability, Capacitance Tolerance, and Temperature Coefficient of Capacitance must be considered in replacement applications.

That's why the Sprague Ceramic Line is varied and broad—it includes capacitors with electrical and mechanical characteristics to meet practically every replacement requirement.

See complete listings in the new Sprague Catalog C-614. Get your copy from any Sprague Distributor, or write to Sprague Products Co., 81 Marshall St., North Adams, Massachusetts.

### CERA-MITE® CAPACITORS



Tiny, tough, dependable. Silvered flat-plate construction for high by-pass efficiency, high self-resonant frequency. Available in the following types to meet specific requirements:

- *General Application*, for by-pass and coupling
- *High-K*, for applications requiring guaranteed minimum capacitance values
- *Temperature-Stable*, for minimum capacitance change with temperature
- *Temperature-Compensating*, for applications requiring negative temperature coefficient
- *NPO*, for use where capacitance change with temperature is undesirable
- *AC*, rated at 125 VAC
- *Buffer*, rated at 2000 WVDC
- *Low-voltage*, for by-pass and coupling in transistorized circuitry
- *TV Yoke*, rated at 3000 and 5000 WVDC

### HYPERCON® CAPACITORS

Ultra-miniature discs for use in transistorized circuitry. Designed for by-pass and coupling applications in low voltage circuits where high capacitance and low power factor are important considerations. Superior in size and performance to comparably-rated aluminum electrolytic capacitors.

### "UNIVERSAL" CAPACITORS



Have multiple leads. Quick-fix capacitors for on-the-spot repairs. By using certain leads for terminals, connecting certain leads together, and removing certain leads, various ratings may be obtained. Available in General Application as well as High-K types.

### DOORKNOB CAPACITORS



Available in 20 and 30 KV ratings. Molded guard rings lengthen surface creepage path. Complete with variety of screw-in terminals to meet all replacement requirements.

### BUTTONHEAD CAPACITORS

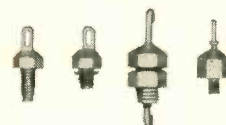

Screw-mounting units with flat disc capacitor elements seated in hexagon head. This series includes feed-thru capacitors for filtering leads through chassis, as well as standoff capacitors for by-pass applications.

### BULPLATE® CAPACITORS

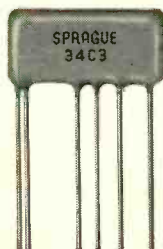

Rugged multiple-section units which combine in one compact assembly all the capacitors used in one or more stages of a radio circuit. These space-saving capacitors are ideal for miniature sets.

**SPRAGUE®**  
THE MARK OF RELIABILITY

WORLD'S LARGEST CAPACITOR MANUFACTURER

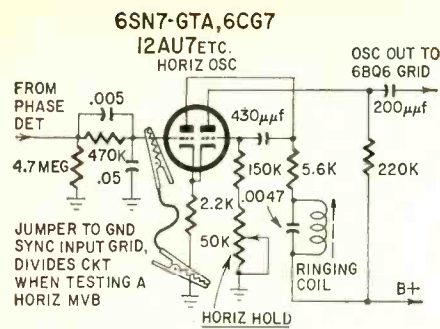

**Fig. 1—Grounding the oscillator's input grid separates it from the phase detector and keeps phase-detector troubles from affecting the oscillator.**

"How's that?"

"Well, as you should know, quite often an off-frequency oscillator is caused by a defect in the phase-detector circuit. There is an easy way to find out when the horizontal oscillator is a multivibrator circuit like this one."

"Oh, I remember, I think you told me once."

"Once!" Cy exclaimed. "I've probably told you a hundred times!"

Lucky ignored the outburst and continued, "We can ground the grid of the oscillator that connects to the phase detector."

"How come you never thought of that before?"

"It just came to me." Lucky grinned. Lucky got a jumper with clips on

either end from the collection hanging on a nail at the end of the bench. He clipped one end to the chassis and the other to the sync input grid on the 6SN7 oscillator (Fig. 1). He turned the set back on and they waited for it to warm up. The raster came on with a bang.

"Well, I'll be," Lucky muttered.

"Doesn't look like we got flyback trouble, does it?" Cy couldn't keep from gloating a little.

"I think I can finish the job now," said Lucky.

"OK, it's all yours, but remember that set has to be delivered this afternoon."

"I know what causes this trouble and I'll have it fixed in no time."

Cy went off to work on another set and Lucky went to the tube rack. He picked out a 6AL5 and replaced the phase detector. There was no improvement in the high voltage.

"Then it's got to be the capacitors," he said to himself. "No use taking chances, I'll replace them all."

An hour later, Lucky was still working on the set or, to be more accurate, was staring at it morosely. Cy looked over his shoulder. "Same set?" he asked dourly.

"I just can't figure it out," Lucky admitted. "I've put in a new 6AL5, I've changed the capacitors and checked the resistors and I still only get high voltage when I short the oscillator sync grid."

"Well, obviously something is unbalancing the phase detector. Have you

measured the voltage on the sync input grid of the oscillator?"

"Sure have. It's 11 volts positive. Funny thing though, I don't have any drive on the 6BQ6 now until I short out the grid of the oscillator."

"With that much positive voltage, I doubt if the oscillator is running at all. Anyway that 'funny' thing that happened should tell you something."

"What's that?"

"It should tell you that you changed the circuit somehow."

"I thought so too," said Lucky, "but I've rechecked the wiring a dozen times."

"You sure the 6AL5 you put in is good? Unbalance here can cause trouble, though it doesn't happen as often with a tube as with the semiconductor diodes."

"That's the third 6AL5 I've put in."

"Well, you also replaced the most likely culprits, the .001 coupling capacitors from the sync inverter" (Fig. 2).

"And also the bypass at the plate and cathode of the 6AL5 where the sampling pulse from the flyback transformer is fed in."

"Looks as if we're going to have to get out the scope," said Cy.

He turned on the scope. Using a low-capacitance probe, he touched the sync input plate terminal of the 6AL5 phase detector. The waveform on the scope was clean with an amplitude of about 20 volts peak to peak. He moved the probe to the sync input cathode (in the other section of the 6AL5).

The waveform should have been

# EXAMINE ANY OF THESE TESTERS BEFORE YOU BUY

SUPERIOR'S NEW MODEL 85 TRANS-CONDUCTANCE TYPE

## TUBE TESTER

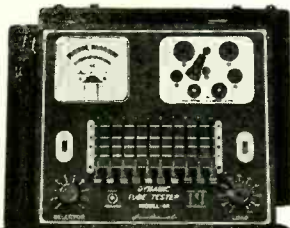

Model 85—Trans-Conductance Tube Tester. Total Price...\$52.50  
Terms: \$12.50 after 10 day trial, then \$8.00 monthly for 5 months if satisfactory. Otherwise return, no explanation necessary.

• FREE FIVE (5) YEAR CHART DATA SERVICE. Revised up-to-date subsequent charts will be mailed to all Model 85 purchasers at no charge for a period of five years after date of purchase.

Model 85 comes complete, housed in a handsome portable cabinet with slip-on cover. Only

**\$52.50**

• Employs latest improved TRANS-CONDUCTANCE circuit. Test tubes under "dynamic" (simulated) operating conditions. An in-phase signal is impressed on the input section of a tube and the resultant plate current change is measured as a function of tube quality. This provides the most suitable method of simulating the manner in which tubes actually operate in radio, TV receivers, amplifiers and other circuits. Amplification factor, plate resistance and cathode emission are all correlated in one meter reading.

• SYMBOL REFERENCES: Model 85 employs time-saving symbols (•, +, •, A, B) in place of difficult-to-remember letters previously used. Repeated time-studies proved to us that use of these scientifically selected symbols speeded up the element switching step. As the tube manufacturers increase the release of new tube types, this time-saving feature becomes necessary and advantageous.

• "FREE-POINT" LEVER TYPE ELEMENT SWITCH ASSEMBLY marked according to RETMA basing, permits application of test voltages to any of the elements of a tube.

SUPERIOR'S NEW MODEL TW-11 STANDARD PROFESSIONAL

## TUBE TESTER



Model TW-11—TUBE TESTER  
Total Price...\$47.50  
Terms: \$11.50 after 10 day trial, then \$6.00 per month for 6 months if satisfactory. Otherwise return, no explanation necessary.

• Uses the new self-cleaning Lever Action Switches for individual element testing. Because all elements are numbered according to pin-number in the RMA base numbering system, the user can instantly identify which element is under test.

• Free-moving built-in roll chart provides complete data for all tubes. All tube listings printed in large-easy-to-read type.

• NOISE TEST: Phono-jack on front panel for plugging in either phones or external amplifier will detect microphonic tubes or noise due to faulty elements and loose internal connections.

• SEPARATE SCALE FOR LOW-CURRENT TUBES—Previously, on emission type tube testers, it has been standard practice to use one scale for all tubes. As a result, the calibration for low-current types has been restricted to a small portion of the scale. The extra scale used here greatly simplifies testing of low-current types.

The Model TW-11 comes housed in a handsome, portable, saddle-stitched Texon case.

**\$47.50**

## DID YOU EVER

Obviously prompt shipment and attention to orders is an essential requirement in our business... We ship at our risk!

- Order merchandise by mail, including deposit or payment in full, then wait and write... wait and write?
- Purchase anything on time and sign a lengthy complex contract written in small difficult-to-read type?
- Purchase an item by mail or in a retail store then experience frustrating delay and red tape when you applied for a refund?



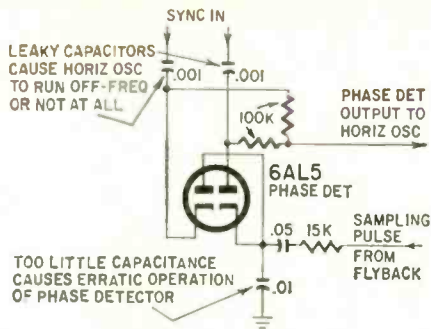

Fig. 2—Capacitors can make trouble in the phase detector. Note the possible trouble points.

about the same except reversed in polarity. What Cy and Lucky saw was almost unrecognizable in form with a peak-to-peak of over 35 volts.

"Either we're getting a peculiar output from the sync phase splitter or from somewhere else," mused Cy.

"How can we tell?" Lucky asked.

"Let's pull out the 6AL5 and check again."

When they did this, both test points had almost identical pulses except with opposite polarity.

"We're getting close," said Cy.

"What is it?" asked Lucky anxiously.

Cy didn't answer. Instead he moved a capacitor, looked at it, smiled wryly, picked up the cutters and clipped it out. He still didn't answer when Lucky asked if the capacitor was bad. Cy just reached for a .01- $\mu$ f capacitor, soldered it in, and turned the set back on. The

raster came on bright with a locked in picture.

"Was that capacitor bad?" Lucky wanted to know again.

"I don't know," said Cy.

"What do you mean you don't know?"

"I don't know whether it is bad or not, but I doubt if it is. But I can tell you one thing."

"What's that?"

"It's a .001."

"Yeah, I know," said Lucky, "I just put it in."

"Yeah, I know," growled Cy. "You should check the capacitors you're installing. Or better yet *don't* install a capacitor if the old one checks good. Did you check the leakage of the capacitors you replaced?"

"One was pretty bad," said Lucky, "so I thought I had better not take any chances with the others. What happened?"

"Well," Cy said, as if resigned to his fate, "an .01 is used to bypass the sampling pulse in this circuit. You obviously replaced the sync feed .001 that was giving the original trouble *BUT* you replaced this .01 with a .001 also and you *created* a new trouble that looked almost the same as the original one. When that kind of thing happens, it can throw even a good technician for a loop."

"You're telling me," Lucky said, Cy thought maybe a *little* sheepishly. "Just what happened?"

"Look at the circuit" (Fig. 3), commanded Cy. "You'll see that the sampling pulse from the flyback is fed

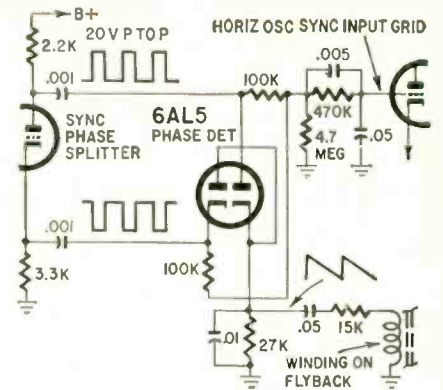

Fig. 3—Phase-detector circuit causing Lucky's Truetone trouble.

through an R-C network to one cathode and the opposite plate of the 6AL5. Installing the wrong capacitor increased the sampling pulse about 10 times. The increased positive pulse caused the right side of the 6AL5 to conduct more than normal. The extra voltage didn't affect the left side of the 6AL5 because the pulses were fed to the cathode, as you saw when we looked at the waveform with the scope."

"And that caused the unbalance and the excessive voltage at the oscillator tube," finished Lucky.

"After a deal like that I think I should change your name from Lucky Shott to Pott Shott. You land on a circuit just like a greedy hunter lands on quail." END

## YES, WE OFFER TO SHIP AT OUR RISK ONE OR MORE OF THE TESTERS DESCRIBED ON THESE PAGES AND FOLLOWING PAGES

SUPERIOR'S NEW MODEL 83A

### C.R.T. TESTER

Tests and Rejuvenates ALL PICTURE TUBES



**ALL BLACK AND WHITE TUBES**  
From 50 degree to 110 degree types  
—from 8" to 30" types.

#### ALL COLOR TUBES

Test ALL picture tubes—in the carton—out of the carton—in the set!

Model 83A provides separate filament operating voltages for the older 6.3 types and the newer 8.4 types.

Model 83A properly tests the red, green and blue sections of color tubes individually — for each section of a color tube contains its own filament, plate, grid and cathode.

Model 83A will detect tubes which are apparently good but require rejuvenation. Such tubes will provide a picture seemingly good but lacking in proper definition, contrast and focus.

Rejuvenation of picture tubes is not simply a matter of applying a high voltage to the filament. Such voltages improperly applied can strip the cathode of the oxide coating essential for proper emission. The Model 83A applies a selective low voltage uniformly to assure increased life with no danger of cathode damage.

Comes housed in handsome portable Saddle Stitched Texon case —complete with sockets for all black and white tubes and all color tubes. Only... **\$38.50**

Try any of the instruments on this page, the facing page and the following pages—for 10 days before you buy. If completely satisfied then send down payment and pay balance as indicated on coupon. No Interest or Finance Charges Added! If not completely satisfied return unit to us, no explanation necessary.

SUPERIOR'S NEW MODEL 88

### TESTS ALL TRANSISTORS AND TRANSISTOR RADIOS



AS A TRANSISTOR RADIO TESTER

An R.F. Signal source, modulated by an audio tone is injected into the transistor receiver from the antenna through the R.F. stage, past the mixer into the I.F. Amplifier and detector stages and on to the audio amplifier. This injected signal is then followed and traced through the receiver by means of a built-in High Gain Transistorized Signal Tracer until the cause of trouble is located and pinpointed.

AS A TRANSISTOR TESTER

The Model 88 will test all transistors including NPN and PNP, silicon, germanium and the new gallium arsenide types, without referring to characteristic data sheets. The time-saving advantage of this technique is self-evident. A further benefit of this service is that it will enable you to test new transistors as they are released!

Model 88 —Transistor Radio Tester and Dynamic Transistor Tester. Total Price...\$38.50  
Terms: \$8.50 after 10 days trial, then \$6.00 monthly for 5 months if satisfactory. Otherwise return, no explanation necessary.

Comes housed in a handsome portable case. Complete with a set of Clip-On Cables for Transistor Testing, an R.F. Diode Probe for R.F. and I.F. Tracing, an Audio Probe for Amplifier Tracing and a Signal Injector Cable—Only. **\$38.50**

MOSS ELECTRONIC, INC., Dept. D-883, 3849 Tenth Ave., New York 34, N. Y.

Please send me the units checked on approval. If completely satisfied I will pay on the terms specified with no interest or finance charges added. Otherwise, I will return after a 10 day trial positively cancelling all further obligations.

- |   |   |
|---|---|
| <input type="checkbox"/> Model 85 . . . Total Price \$52.50<br>\$12.50 within 10 days. Balance<br>\$8.00 monthly for 5 months.  | <input type="checkbox"/> Model TW-11 Total Price \$47.50<br>\$11.50 within 10 days. Balance<br>\$6.00 monthly for 6 months.   |
| <input type="checkbox"/> Model 83-A . . . Total Price \$38.50<br>\$8.50 within 10 days. Balance<br>\$6.00 monthly for 5 months. | <input type="checkbox"/> Model 88 . . . Total Price \$38.50<br>\$8.50 within 10 days. Balance<br>\$6.00 monthly for 5 months. |

Name .....

Address .....

City ..... Zone ..... State .....

All prices net, F.O.B. N.Y.C.

Export Division: Roake International Corp.  
13 East 40th St., New York 16, N. Y.

## A "brass-tacks" guide to TIME-SAVING TEST PROCEDURES!

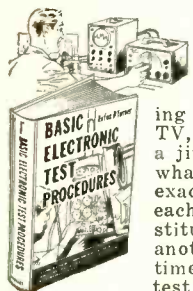

**BASIC ELECTRONIC TEST PROCEDURES** is a big new 316-page manual with the kind of "brass tacks" training that helps you locate TV, AM and FM troubles in a jiffy. Teaches you exactly what instruments to use and exactly when and how to use each type. Tells how to substitute one instrument for another and how to develop time-saving, money-making test methods.

### The Manual That Helps You Cut Testing Time in Half!

Here are some of the subjects it covers: Current Checks; making measurements of Power, Capacitance, Inductance, Resistance, AF, RF, Phase, Distortion & Modulation; checking Sensitivity, RF Gain, Fidelity, AVC Voltage, Operating Voltages, etc. Includes handy **VISUAL ALIGNMENT TECHNIQUES**. Even covers transmitter and industrial electronic test procedures. 190 how-to-do-it pictures and dozens of step-by-step troubleshooting procedures charts make things doubly easy. Price only \$8.00. Money-back guarantee.

### PRACTICE 10 DAYS FREE!

Dept. RE-51, Technical Division  
**HOLT, RINEHART & WINSTON, INC.** 623900  
383 Madison Ave., New York 17, N. Y.  
Send **BASIC ELECTRONIC TEST PROCEDURES** Manual for 10-day free examination. If I like book, I will then send \$8.00 (plus postage) in full payment. Otherwise, I will return manual and owe you nothing. (SAVE! Send \$8.00 with order and we pay postage. Same 10-day return privilege with money refunded promptly.) No. 708933  
Name.....  
Address.....  
City, Zone, State.....  
**OUTSIDE U.S.A.—\$8.50 cash. 10-day money-back guarantee**  
Above Offer expires Jan. 31, 1962

## Simple voltage control box

By **JAMES A. FRED**

**H**ow many times have you wanted to raise or lower the electric line voltage in your house? Several devices are made for this purpose, but they are all quite expensive. To take care of this situation we designed a circuit using a transformer and two slide switches.

The theory that makes the circuit simple and effective is that of series-aiding and series-opposing alternating-current circuits. This theory states that voltages of the same polarity oppose and that voltages of opposite polarities aid each other. This can best be illustrated by Fig. 1. Here we see a transformer with a primary and a secondary winding (Fig. 1-a). We'll assume that the voltage on the secondary is 10 volts. At any given instant during every cycle of our alternating current, points 1 and 3 will be negative and points 2 and 4 will be positive. Now, if we connect 2 and 3, we have series-aiding and get a total of 125 volts between 1 and 4. This is the sum of the 115 volts from the line, plus the 10 volts from the secondary of our transformer (Fig. 1-b). Now let's go back to Fig. 1-a again. This time we connect points 1 and 3 and points 2 and 4. This places two minus points together and two plus points together, giving us a series-

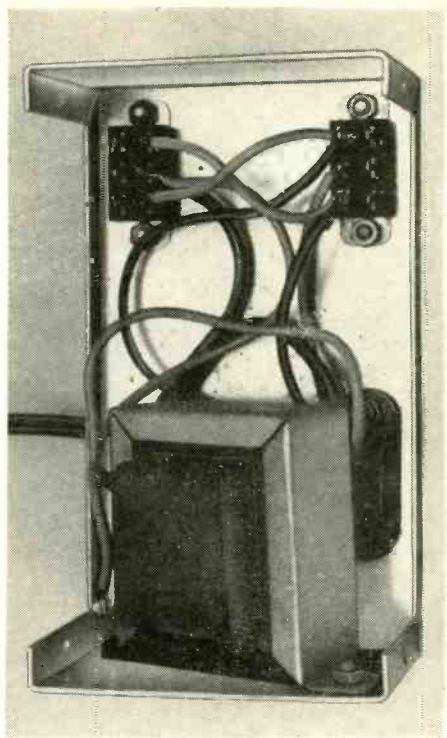

There are only three basic components inside the case.

opposing circuit and a total output voltage of 105—the 10 volts from the secondary being subtracted from the 115 volts of the line voltage as in Fig. 1-c.

As you see, we can get two voltages

# EXAMINE ANY OF THESE TESTERS BEFORE YOU BUY

SUPERIOR'S NEW MODEL 70 UTILITY TESTER

## FOR REPAIRING ALL ELECTRICAL APPLIANCES • MOTORS • AUTOMOBILES

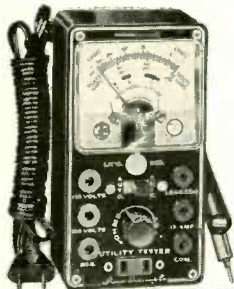

As an electrical trouble shooter the Model 70:

- Will test Toasters, Irons, Broilers, Heating Pads, Clocks, Fans, Vacuum Cleaners, Refrigerators, Lamps, Fluorescents, Switches, Thermostats, etc.
- Measures A.C. and D.C. Voltages, A.C. and D.C. Current, Resistances, Leakage, etc.
- Incorporates a sensitive direct-reading resistance range which will measure all resistances commonly used in electrical appliances, motors, etc.
- Leakage detecting circuit will indicate continuity from zero ohms to 5 megohms (5,000,000 ohms).

As an Automotive Tester the Model 70 will test:

- Both 6 Volt and 12 Volt Storage Batteries
- Generators
- Starters
- Distributors
- Ignition Coils
- Regulators
- Relays
- Circuit Breakers
- Cigarette Lighters
- Stop Lights
- Condensers
- Directional Signal Systems
- All Lamps and Bulbs
- Fuses
- Heating Systems
- Horns
- Also will locate poor grounds, breaks in wiring, poor connections, etc.

**Model 70—Utility Tester**  
Total Price ..... **\$15.85**  
Terms: \$3.85 after 10 day trial, then \$4.00 monthly for 3 months, if satisfactory. Otherwise return, no explanation necessary.

### INCLUDED FREE

64 page condensed course in electricity. Profusely illustrated. Written in simple, easy-to-understand style.

Model 70 comes complete with book and test leads.

Only  
**\$15<sup>85</sup>**

SUPERIOR'S NEW MODEL 80

## 20,000 OHMS PER VOLT **ALLMETER**

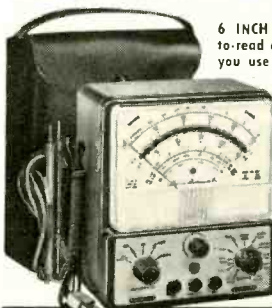

6 INCH FULL-VIEW METER provides large easy-to-read calibrations. No squinting or guessing when you use Model 80.

MIRRORED SCALE permits fine accurate measurements where fractional readings are important.

### SPECIFICATIONS:

- D.C. VOLTAGE RANGES:**  
(At a sensitivity of 20,000 Ohms per Volt) 0 to 15/75/150/300/750/1500/7500 Volts.
- A.C. VOLTAGES RANGES:**  
(At a sensitivity of 5,000 Ohms per Volt) 0 to 15/75/150/300/750/1500 Volts.
- RESISTANCE RANGES:**  
0 to 2,000/200,000 Ohms. 0-20 Megohms.
- CAPACITY RANGES:**  
.00025 Mfd. to .3 Mfd., .05 Mfd. to 30 Mfd.
- D.C. CURRENT RANGES:**  
0-75 Microamperes, 0 to 7.5/75/750 M.illiamperes, 0 to 15 Amperes.
- DECIBEL RANGES:**  
-6 db to +18 db, +14 db to +38 db, +34 db to +58 db.

NOTE: The line cord is used only for capacity measurements. Resistance ranges operate on self-contained batteries.

Model 80 Allmeter comes complete with operating instructions, test leads and portable carrying case. Only .....

**\$42<sup>50</sup>**

## DID YOU EVER

- Order merchandise by mail, including deposit or payment in full, then wait and write... wait and write?
- Purchase anything on time and sign a lengthy complex contract written in small difficult-to-read type?
- Purchase an item by mail or in a retail store then experience frustrating delay and red tape when you applied for a refund?

Obviously prompt shipment and attention to orders is an essential requirement in our business... We ship at our risk!

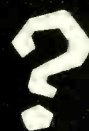

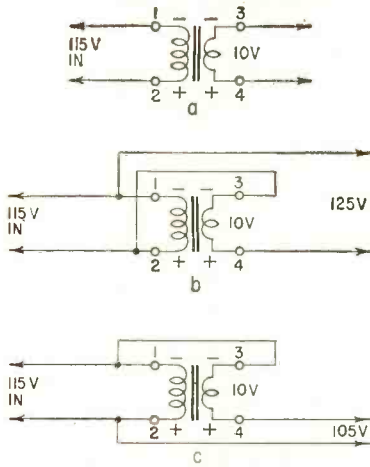

Fig. 1—Basic transformer; b—hook-up for series-aiding and (c) for series-opposing.

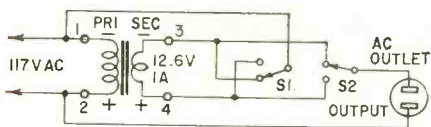

Fig. 2—Circuit of voltage control box.

with only one low-voltage transformer. We can go a step further and also get the line voltage, giving us three voltages. This is a highly desirable combination, and we wanted to take advantage of it.

We considered several switching cir-

cuits, finally designing a simple one using two single-pole double-throw slide switches (Fig. 2). Two slide switches are wired to a transformer. By putting both switches in the up position, we get about 125 volts output. By putting both of them in the down position, we get about 105 volts. By putting them in opposite directions (either one up and the other one down), we get the line voltage as the output.

As you can see from the photos, the voltage control box is made as simple as possible. You can dress it up if you like by adding a line switch and a pilot light. This unit has a transformer whose secondary puts out 12.6 volts at 100 watts. We can use such a small transformer on such a large load because the transformer supplies only about 10% of the load.

The transformer, switches and receptacle are mounted in a 2 1/4 x 3 x 5-inch aluminum box. The parts are crowded, but they run cool when in use.

There are two precautions to take when wiring the unit. Do not make any connections to the case or it will be hot. Also, if you cannot identify points 1, 2, 3, 4 on your transformer, you need not worry. Just wire it up, observing the primary and secondary wires, and connect an ac meter or light bulb to the output. Push both switches up. If the voltage doesn't increase or the light bulb get brighter, reverse the connections to the primary winding. This is the only change you need to make. END

## BUILD-YOUR-OWN ELECTRONIC ORGAN

STEP UP TO AN

*Artisan*

GREATEST NAME IN ORGAN KITS

20TH CENTURY SUCCESSOR TO THE PIPE ORGAN



PIPE-LIKE TONE AND APPEARANCE

DIRECT FACTORY TO OWNER SAVES 50%



PAY-AS-YOU BUILD STEP-BY-STEP INSTRUCTIONS HOME, CHURCH AND CONCERT MODELS 2-3-4 MANUALS FROM \$1,750 to \$12,500



WORLD'S LARGEST SELECTION OF ORGAN-KITS, ACCESSORIES AND CUSTOM-BUILT ORGANS

Send for FREE literature

ELECTRONIC ORGAN ARTS, INC. 4949R YORK BLVD., LOS ANGELES 42, CALIF.

## YES, WE OFFER TO SHIP AT OUR RISK ONE OR MORE OF THE TESTERS DESCRIBED ON THESE PAGES AND PRECEDING PAGES

SUPERIOR'S NEW MODEL TV-50A

### GENOMETER 7 Signal Generators in One!

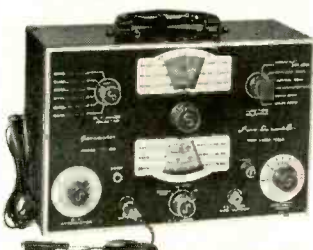

Model TV-50A—Genometer  
Total Price \$47.50  
Terms: \$11.50 after 10 day trial, then \$6.00 monthly for 6 months if satisfactory. Otherwise return, no explanation necessary.

- ✓ R.F. Signal Generator for A.M.
- ✓ R.F. Signal Generator for F.M.
- ✓ Audio Frequency Generator
- ✓ Bar Generator
- ✓ Marker Generator
- ✓ Color Dot Pattern Generator
- ✓ Cross Hatch Generator

A versatile all-inclusive GENERATOR which provides ALL the outputs for servicing:  
A.M. Radio • F.M. Radio • Amplifiers • Black and White TV • Color TV

The Model TV-50A comes complete with shielded leads and operating instructions. Only

**\$47.50**

Try any of the instruments on this page, the facing page and the preceding pages—for 10 days before you buy. If completely satisfied then send down payment and pay balance as indicated on coupon. No Interest or Finance Charges Added! If not completely satisfied return unit to us, no explanation necessary.

SUPERIOR'S NEW MODEL 79

### SUPER-METER

WITH NEW 6" FULL VIEW METER



Model 79—Super-Meter  
Total Price \$38.50  
Terms: \$8.50 after 10 day trial, then \$6.00 per month for 5 months, if satisfactory. Otherwise return, no explanation necessary.

SPECIFICATIONS: D.C. VOLTS: 0 to 7.5/15/75/150/750/1,500 • A.C. VOLTS: 0 to 15/30/150/300/1,500/3,000 • D.C. CURRENT: 0 to 1.5/15/150 Ma. • 0 to 1.5/15 Amperes • RESISTANCE: 0 to 1,000/100,000 Ohms • 0 to 10 Meg-ohms • CAPACITY: .001 to 1 Mfd. 1 to 50 Mfd. • REACTANCE: 50 to 2,500 Ohms. 2,500 Ohms to 2.5 Megohms • INDUCTANCE: .15 to 7 Henrys, 7 to 7,000 Henrys • DECIBELS: -6 to +16, +14 to +38, +34 to +58.

The following components are all tested for QUALITY at appropriate test potentials. Two separate BAD-GOOD scales on the meter are used for direct readings: All-Electrolytic Condensers from 1 MFD to 1000 MFD • All Selenium Rectifiers • All Germanium Diodes • All Silicon Rectifiers • All Silicon Diodes.

Model 79 comes complete with operating instructions and test leads. Only

**\$38.50**

MOSS ELECTRONIC, INC., Dept. D-883 3849 Tenth Ave., New York 34, N. Y.

Please send me the units checked on approval. If completely satisfied I will pay on the terms specified with no interest or finance charges added. Otherwise, I will return after a 10 day trial positively cancelling all further obligations.

- Model 70... Total Price \$15.85 \$3.85 within 10 days. Balance \$4.00 monthly for 3 months.
- Model 79... Total Price \$38.50 \$8.50 within 10 days. Balance \$6.00 monthly for 5 months.
- Model TV-50A Total Price \$47.50 \$11.50 within 10 days. Balance \$6.00 monthly for 6 months.
- Model 80... Total Price \$42.50 \$12.50 within 10 days. Balance \$6.00 monthly for 5 months.

Name .....

Address .....

City ..... Zone ..... State .....

All prices net. F.O.B. N.Y.C.

Export Division: Roctec International Corp., 13 East 40th St., New York 16, N. Y.

**S**EVERAL makes and types of tunnel diodes can now be bought over the counter. We may expect, therefore, that a great deal of experimenting with this interesting new component is under way. But the tunnel diode is still relatively high-priced, so many an experimenter for the time being will own only one. To avoid damaging this one diode and to keep it operating as it ought to, it must be handled properly. Until tunnel-diode prices drop to 50 cents each, the experimenter will want to be extra careful.

What must be done? Here are a few simple do's and don't's, based upon good semiconductor practice and my own (sometimes sad) experience with tunnel diodes.

1. Use a low-resistance dc bias supply. The dc bias voltage must be supplied by a source whose internal resistance is lower than the negative resistance of the diode. Depending upon diode characteristics, the supply resistance should be no higher than 5 to 20 ohms. Use the lowest obtainable value. A satisfactory method is to take the bias across a low-resistance leg of a stiff voltage divider operated from a battery or well filtered rectifier. Make a part of the higher-resistance leg of the divider variable so the bias voltage may be adjusted. But keep a part of the higher resistance fixed so that there is no danger of applying the full battery voltage to the diode.

2. Check the dc operating point. That is, run through the diode conduction characteristic (Fig. 1) by varying the dc bias voltage and observing the resulting current. (An identical current reading may be obtained along both the positive and negative slopes but at different voltages. It is necessary to know whether current is increasing or decreasing with voltage.) The proper operating point for most experiments is in the negative-resistance region, where current decreases as voltage is increased. Thus, in Fig. 1, the same current flows at point A, (voltage  $E_1$ ), point B ( $E_2$ ) and point C ( $E_3$ ), but only point B is in the negative-resistance region.

3. Take into account the voltage drop across the current meter when testing a diode. The milliammeter or microammeter used in the test has a definite internal resistance which introduces a voltage drop into the circuit. Thus, in Fig. 2, the output voltage across the 10-ohm leg of the voltage divider ( $R_2$ ) is 150 mv—one-tenth of 1.5 volts—and the observed current is 0.5 ma. However, the diode bias is not 150 mv, because 0.5 ma produces a voltage drop of 25 mv across the 50-ohm milliammeter, but is  $150 - 25 = 125$  mv. Since the internal resistance of the meter is in series with the diode, it can influence the latter's response. Therefore, always use the lowest-resistance current meter obtainable.

4. Don't test a diode with an ohmmeter. The voltage applied to the diode by the ohmmeter may be high enough to damage the diode. Furthermore, this simple test may not be as informative

# CARE AND HANDLING OF TUNNEL DIODES

*A dozen do's and don'ts that extend the life of those expensive negative resistance diodes*

By RUFUS P. TURNER

as it sometimes is when testing conventional diodes and rectifiers, since the front-to-back resistance ratio of the tunnel diode normally may not be high.

5. Watch polarity. At the normal bias voltage, reversing the diode should cause no damage, but it will prevent normal operation. For negative resistance, the diode must be forward-biased: anode positive, cathode negative.

6. Don't use excessive input-signal voltage in diode amplifiers. Excessive signal-voltage peaks will drive the diode out of its negative-resistance region.

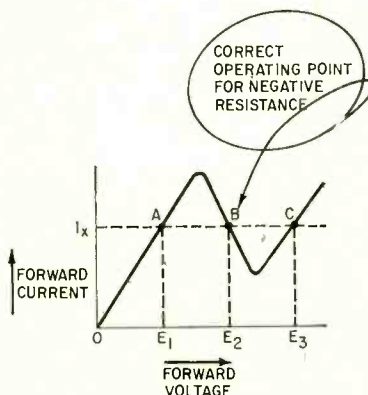

Fig. 1—Conduction characteristic—current  $I_x$  flows at points A, B and C, but only point B is in negative resistance region.

Linearity is enhanced when the peak signal voltage is small with respect to the dc bias voltage.

7. Protect the diode from surges. Protect the diode from destructive kickback voltages by installing a safety device (varistor, surge-limiting resistor or reverse-connected germanium, silicon or selenium diode) across any high-inductance coil in the circuit (Fig. 3). High kickback voltages produced by collapse of the magnetic field of a high-L coil can wreck a diode in a fraction of a second.

8. Don't exceed maximum recommended temperature. Consult the diode manufacturer's data sheet for the maximum temperatures at which the diode may be operated or stored. If the temperature ratings must be exceeded, apply any derating factors specified by the manufacturer. Usually, this involves reducing bias or signal voltages.

9. Don't exceed maximum rated power dissipation. The dc power input (P) to the diode is the product of the bias voltage and the resulting current:  $P = EI$ , where P is in watts, E in volts and I in amperes. If E is expressed in millivolts and I in milliamperes,  $P = .001EI$  milliwatts. Consult the manufacturer's data sheet for maximum permissible power dissipation at the desired operating temperature. Excessive dissipation can shift the diode operating point, upset operation of a circuit or destroy the diode.

10. Don't operate the diode in a strong alternating magnetic field. A strong ac magnetic field (either audio-frequency or radio-frequency) may induce damaging currents in the diode structure.

11. Do heat-sink when soldering or welding. This is a precaution with all diodes and transistors. A simple method is to hold the pigtail with pliers (between the point of heating and the body of the diode.) until the joint is completely cooled.

12. Do check the circuit carefully. Check all wiring for correctness before installing the diode. Then check again before switching on the power. It is good practice to install the diode in a circuit last and to remove it first. END

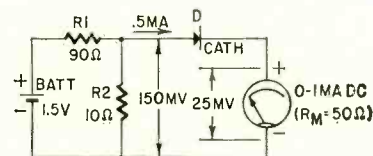

Fig. 2—Tunnel-diode test circuit.

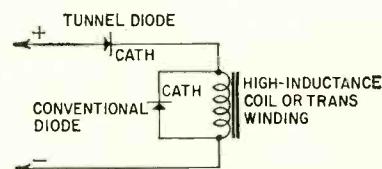

Fig. 3—Protective circuits use standard diode across high-inductance coils.

# new PRODUCTS

**MINIATURE CERAMIC TRIMMER CAPACITOR, Style 533.** 3/8-in. diameter. Operating temperature



to 125°C. 200 working volts dc. Q factor at 1MC 500 minimum. Flash-test voltage 400 dc.—**Eric Resistor Corp.**, 644 W. 12th St., Erie, Pa.

**FLYBACK TRANSFORMERS.** HO-320 replaces RCA 103839 and Sylvania 241-0046/48; HO-326,

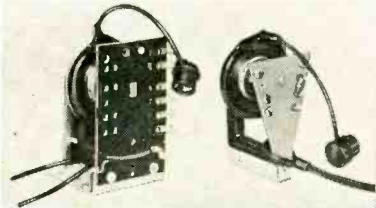

Meek Part No. THC-10021; HO-332, Magnavox Part Nos. 360580-1 and 360604-1, HO-333. Magnavox Part No. 360700-1/2.—**Chicago Standard Transformer Corp.**, 3501 W. Addison St., Chicago 18, Ill.

**TRANSISTOR TRANSFORMERS**, miniaturized to save space. Bud 5/16 in high; Mite, 3/8-in di-



ameter. 42 designs in either style. Encased in drawn steel cans with nickel-alloy leads on standard 0.1-inch spacings for printed-circuit mounting.—**Deeco, Inc.**, 2025 Farrington, Dallas, Tex.

**UTILITY AC POWER SUPPLY, HP-20**, for radio amateur. Furnishes filament, plate and

bias voltages when converting mobile amateur gear to fixed-station operation. 8 amps at 6.3 volts ac or 4 amps at 12.6 volts ac. Plate power



600 volts dc at 200 ma or 600 volts dc at 150 ma and 300 volts dc at 100 ma. Separate bias supply for 130 volts dc at 30 ma.—**Heath Co.**, Benton Harbor, Mich.

**CITIZENS-BAND TRANSCEIVER, Osborne 300** is 1 7/8 x 6 x 7 in. 9-transistor circuit. 4-channel selector with plug-in crystals. Operates on any

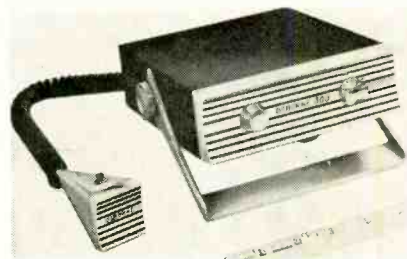

of 23 allocated Citizens-Band channels. All-metal die-cast case.—**Osborne Electronic Sales Corp.**, 13105 S. Crenshaw Blvd., Hawthorne, Calif.

**CITIZENS-BAND TRANSCEIVER, deluxe, HE Series.** 5-watt input crystal-controlled transmitter operates on any 4 of 23 channels. Super-heterodyne receiver section tunable over all 23 channels with 1-μv sensitivity. Combination S-meter and transmitter plate-current indicator. Built-in 115-volt ac/12-volt dc power supply for

**TV-RADIO Servicemen or Beginners . . .**

Send for *Coyne's*  
7-Volume Job-Training Set  
on 7-Day **FREE TRIAL!**



The First  
Practical  
TV-RADIO-  
ELECTRONICS  
Shop  
Library!

Answers ALL Servicing Problems QUICKLY . . .  
Makes You Worth More On The Job!

Put money-making, time-saving TV-RADIO-ELECTRONICS know-how at your fingertips—examine Coyne's all-new 7-Volume TV-RADIO-ELECTRONICS Reference Set for 7 days at our expense! Shows you the way to easier TV-Radio repair—time saving, practical working knowledge that helps you get the BIG money! How to install, service and align ALL radio and TV sets, even color-TV, UHF, FM and transistorized equipment. New photo-instruction shows you what makes equipment "tick". No complicated math or theory—just practical facts you can put to use immediately right in the shop, or for ready reference at home. Over 3000 pages; 1200 diagrams; 10,000 facts!

**SEND NO MONEY!** Just mail coupon for 7-Volume TV-Radio Set on 7-Day FREE TRIAL! We'll include the FREE BOOK below. If you keep the set, pay only \$3 in 7 days and \$3 per month until \$27.25 plus postage is paid. Cash price only \$24.95. Or return set at our expense in 7 days and owe nothing. Either way, the FREE BOOK is yours to keep. Offer limited, so act NOW!

**"LEARNED MORE FROM THEM THAN FROM 5 YEARS WORK!"**

"Learned more from your first two volumes than from 5 years work."  
—Guy Bliss, New York

"Swell set for either the serviceman or the beginner. Every service bench should have one."  
—Melvin Masbruch, Iowa.

**FREE DIAGRAM BOOK!**

We'll send you this big book. "150 Radio-Television Picture Patterns and Diagrams Explained" ABSOLUTELY FREE just for examining Coyne's 7-Volume Shop Library on 7-Day FREE TRIAL! Shows how to cut servicing time by reading picture-patterns, plus schematic diagrams for many TV and radio sets. Yours FREE whether you keep the 7-Volume Set or not! Mail coupon TODAY!



Like Having An Electronics Expert Right At Your Side!

**VOL. 1—EVERYTHING ON TV-RADIO PRINCIPLES!** 300 pages of practical explanations; hundreds of illustrations.

**VOL. 2—EVERYTHING ON TV-RADIO-FM RECEIVERS!** 403 pages; fully illustrated.

**VOL. 3—EVERYTHING ON TV-RADIO CIRCUITS!** 336 pages; hundreds of illustrations, circuit diagrams.

**VOL. 4—EVERYTHING ON SERVICING INSTRUMENTS!** How they work, how to use them. 368 pages; illustrated.

**VOL. 5—EVERYTHING ON TV TROUBLESHOOTING!** Covers all types of sets, 437 pages; illustrations, diagrams.

**VOL. 6—TV CYCLOPEDIA!** Quick and concise answers to TV problems in alphabetical order, including UHF, Color TV and Transistors; 868 pages.

**VOL. 7—TRANSISTOR CIRCUIT HANDBOOK!** Practical Reference covering Transistor Applications; over 200 Circuit Diagrams; 410 pages.

ALL 7 BOOKS HAVE BRIGHT, MODERN, VINYL CLOTH WASHABLE COVERS

**FREE BOOK—FREE TRIAL COUPON!**

Educational Book Publishing Division

**COYNE ELECTRICAL SCHOOL**

1455 W. Congress Parkway, Dept. 51-T1, Chicago 7, Illinois

Yes! Send me COYNE'S 7-Volume Applied Practical TV-RADIO-ELECTRONICS Set for 7-Days FREE TRIAL per your offer. Include "Patterns & Diagrams" book FREE!

Name ..... Age .....

Address .....

City ..... Zone ..... State .....

Check here if you want Set sent C.O.D. Coyne pays postage on C.O.D. and cash orders. 7-Day Money-Back Guarantee.

**Coyne**

**ELECTRICAL SCHOOL** 1455 W. Congress Parkway Dept. 51-T1, Chicago 7, Illinois

# CUSTOMER SERVICE ENGINEERS



## OUTSTANDING CAREER OPPORTUNITIES

Continued expansion of the PHILCO COMPUTER DIVISION has created a number of positions for persons with a minimum of 2 years of data processing equipment maintenance and/or installation experience.

Successful candidates will undergo advanced computer training in the PHILCO 2000 System at our Willow Grove, Pa. plant.

## ASSIGNMENTS AVAILABLE IN MAJOR CITIES THROUGHOUT U.S.A.

Contact

**Mr. John Felos**

Professional Employment Manager

**COMPUTER DIVISION  
WILLOW GROVE, PA.**

**PHILCO**  
Famous for Quality the World Over



fixed operation.—Lafayette Radio Electronics Corp., 165-08 Liberty Ave., Jamaica 33, N. Y.

**AMATEUR RADIO TRANSMITTER KIT, DX-60.** 90-watt peak power input. Carrier-controlled phone or CW. Covers amateur bands 80 through



10 meters. Reduced power for novice operation. 13½ x 11½ x 6½. 27 lb.—Heath Co., Benton Harbor, Mich.

**HI-FI TV KITS** incorporate special circuits. 23-, 24- or 27-inch picture tubes. Critical circuits

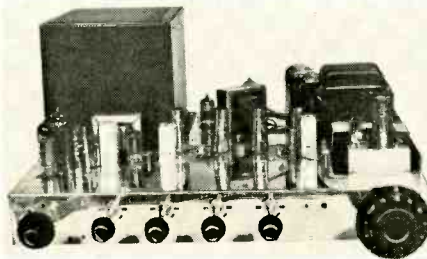

preassembled and aligned. Complete step-by-step instructions.—Transvision, New Rochelle, N. Y.

**MAST-MOUNTED BROAD-BAND TV/FM AMPLIFIER, Model AB-3.** Remote power supply, model RP-3, for reception to full mile from ac power source. Gain 22 db on all vhf TV channels



and FM. Impedance—input 300 ohms; output 75 or 300 ohms. Power required—117 volts, 60 cycles; .34 ampere.—Blonder-Tongue Laboratories Inc., 9-25 Alling St., Newark 2, N. J.

**INDOOR TV ANTENNA, models B7M and B7B, Slim-Line Tune-A-Matic.** 4-section telescoping



dipoles extend to 36 inches. Tip-proof base. Felt-covered bottom.—Clear Beam Antenna Corp., Canoga Park, Calif.

**CARTRIDGES, models HF-2 and HF-5.** Twin-stylus turrets for changeover from 33 1/3 or 45 to 78 rpm. 25-db separation between channels. Low stylus mass for tracking at 2 grams. Lead zir-

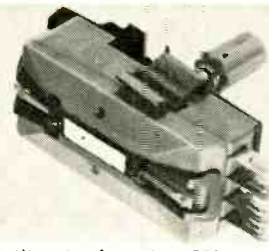

conium titanate elements.—CBS Electronics, Div. of Columbia Broadcasting System, Inc., Danvers, Mass.

**MICROPHONE PLUG-IN CABLES** add extra length to existing cables without tools, wiring or soldering. 25 feet, 2 conductor, shielded. No. 93-BU94 with Amphenol MC3M and MC3F plugs and No. 91BU92 with Cannon and XL3-11 and



XL3-12 plugs.—Switecraft Inc., 5555 N. Elston Ave., Chicago 30, Ill.

**TRANSISTOR MINIATURE TAPE RECORDER, RK-125.** Telephone pickup, earphone, patch cord, microphone, 3-inch reel of tape, empty reel and batteries. 3 transistors. 2 x 3-inch PM speaker and amplifier. 6 x 8¼ x 2¼ in. 2½ lb.—Lafayette



Radio Electronics Corp., 165-08 Liberty Ave., Jamaica 33, N. Y.

**TAPE DECK, Truvox Mark 6,** 3¼ and 7½ ips. 7-inch reels lock on spindles for transit. 3 motors, rewinds at 1,200 feet per minute. Interlocked pushbutton controls. Brake button applies magnetic brakes, off button applies mechanical brakes. Pause button can be locked on. High-impedance half-track mono play, record and erase heads. Available without heads. Record

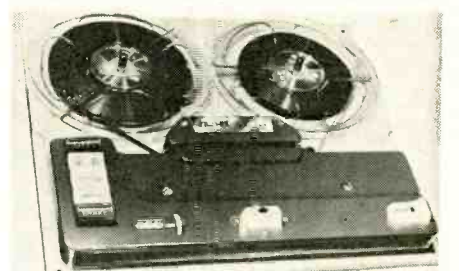

head requires 120 volts bias at 1.5 ma; erase head 150 volts, 11 ma at 50 kc.—M. Swedgal, 258 Broadway, New York, N. Y.

**DELUXE 3-WAY SPEAKER, KN-850,** 12 and 15 inches. Vacuum-formed woofer with chemically treated edge suspension. Mid-frequency radiator mounted in center of woofer. Compress-



RADIO-ELECTRONICS



# EXCLUSIVE ELECTRONICS SALE

FIRST TIME EVER THIS INVENTORY HAS BEEN OFFERED AT FANTASTIC PRICE REDUCTIONS!

## MFR'S INVENTORY LIQUIDATION SPECIAL



### FAMOUS NAME LAB VTVM

±1 DB FREQ. RESP. 10 cps-700 mc & 3/4" TUBE PROBE  
NEVER SOLD FOR LESS THAN... **\$249.00**

#### FEATURES

- Low input cap. 1.2  $\mu$ f
- ±1 db freq. resp. 10 cps to 700 mc.
- Small AC diode probe (3/4" dia) Eimac 201C tube
- Sloping meter front
- Separate AC & DC zeroing controls

**\$99.50**

Exclusive Below Cost Price!

SHIPPED VIA EXPRESS

**SPECIFICATIONS:** Ranges: DC 1-3-10-30-100-300-1000V; AC 1-3-10-30-100-300V. Resistance ranges: 0.2 to 500 megs. Accuracy: DCV ±2%, ACV ±3%. Input imp: DC 100 megs on all ranges. Input resistance is approx. 7 megs. Power supply: 110-120V, 60 cy., 20 watts. Size 6 3/4" w. x 10 1/4" h. x 7" d. Wt. 7 lbs., ship. 14 lbs. Aluminum gray hammertone cabinet; maroon-crackle finish. With power cord & instruction book.

NOW SELLING LIKE "HOT CAKES" FOR LABS, INDUSTRIAL, SHOPS & SCHOOLS

## \$89.95 SLASHED OFF THIS DELUXE MODEL

CITIZENS BAND 6-CHANNEL

### TRANSCIEVER

COMPLETELY WIRED  
DUAL CONVERSION  
SUPERHETERODYNE

- 3 Watts or better output
- .5 Microvolt sensitivity
- 115 VAC & 12 VDC operation
- Use for mobile or fixed station by switching cord
- Powerful 11 tube circuitry



ORIGINALLY SOLD FOR... **\$189.95**

**\$99.50**

- Adjustable Squelch
- Noise Limiter
- Push-to-talk Mike
- Base Loaded Whip IN-CLUDED!

Not 4 & 5 CHANNELS, BUT SIX—CB's Greatest Value!

SINGLE CHANNEL: fixed freq. rcvr & fixed freq. transmitter, microphone antenna. Supplied with crystal. **\$74.50**

SIX CHANNEL: (see above) transceiver includes 6 fixed freq. receiving channels & 6 fixed freq. transmitting channels on single switch, microphone, antenna. Supplied with set of crystals for channel 5.

BOTH MODELS ARE THE "CADILLACS" OF CITIZENS BAND—LIMITED QUANTITY

- SOCKETS, Eby PC7 & PC9 printed circuit. Specify 7 or 9 pin. Reg. 12¢ ea. ea. 2¢
- SOCKETS, 7-pin shielded. ea. 2¢
- SOCKETS, 7-pin unshielded. ea. 2¢
- SOCKETS, 9-pin unshielded. ea. 2¢
- SOCKETS, 9-pin printed circuit. ea. 2¢
- SOCKETS, 7-pin printed circuit. ea. 2¢
- SOCKETS, 4-prong water. ea. 4¢
- SOCKETS, 8-pin, ceramic. ea. 7¢
- SOCKETS, 9-pin. ea. 12¢
- KNOBS, channel selector, 1 1/2" pointer. ea. 16¢
- POINTER KNOBS, 1 1/2" long 3/4" shaft. ea. 19¢
- 3-IN. INSTRUMENT KNOBS, 3/4" shaft. ea. 29¢
- 2 1/4-IN. INSTRUMENT KNOBS, 3/4" shaft. ea. 14¢
- Famous Brand RESISTORS, 250Ω, 10W, 10%. ea. 7¢
- 5W WIREWOUND resistors, 93 ohms. ea. 5¢
- 5W WIREWOUND resistors, 72 ohms. ea. 5¢
- 5W WIREWOUND resistors, 2.2K. ea. 8¢
- 5W WIREWOUND resistors, 150 ohms. ea. 8¢
- SHALLCROSS and EPR, .5% & 1% to 1; printed circuit precision resistors. Reg. 90¢ ea. ea. 39¢
- 2W-47 ohms □ 2W-2K □ 2W-10K
- 2W-1K □ 2W-200ohms □ 2W-15K
- 2W-1500ohms □ 2W-5100ohms □ 2W-20K
- KENYON T-396, HL. transmr. 6.3V-30A. worth \$30. ea. \$7.95
- TRP-44 TRANSFMR., 2 45V windings @ 15ma ea., 6.3V @ 1.2A, 12.6V @ 1.2A, 18.9V @ 1.2A. Pri. 115 VAC. 98¢
- UTC C-16, output transmr., popular for hi-fi; 20 watts, 5000 ohms plate to plate; pair of 6L6's. \$1.75
- IF TRANSFMRs., 455 Kc, printed circuit. 66¢
- 2.5 MH R.F. CHOKES. ea. 28¢
- TCV271-28 POWER TRANSFMR., pri. 115VAC, sec. 500 VCT @ 90 ma, 12.6 @ 3A; for vibration power; 115VAC. ea. \$3.40
- IF TRANSFORMER MTG. PLATES. ea. 1¢
- ±6 GROUND LUGS. per 1000 \$1.02
- CAPACITORS, 500 mfd @ 50 VDC. ea. 69¢
- CAPACITORS, 2000 mfd @ 25 VDC. ea. 79¢
- Famous Make CAPACITORS, 800u mfd @ 55 VDC; 10 for \$22. ea. \$2.49
- GLASS SEALED, Pyramid, Aerovox, Sprague... 16¢
  - .47 @ 100V □ 1 mfd @ 300V □ .33 @ 300V
  - .68 @ 100V □ .22 @ 400V □ .47 @ 300V
  - .033 @ 200V □ .1 @ 100V □ .68 @ 300V
  - .1 @ 200V □ 1 mfd @ 100V □ .01 @ 400V
  - .15 @ 200V □ .01 @ 200V □ .047 @ 400V
  - .22 @ 200V □ .1 @ 300V □ .1 @ 400V
  - .47 @ 200V □ .15 @ 300V □ 1 mfd @ 400V
  - .082 @ 300V □ .22 @ 300V □ 10 for \$1.50
- Famous Brand, rect. can, 4 mfd @ 400V, oil ea. 79¢
- ELECTROLYTIC, 4 mfd 600V, 4 1/2 x 1 1/2" can. ea. 39¢
- BATHTUBS, 2x.5 mfd @ 600V, w/mtg. bracket 19¢
- CAPACITORS, 80/40/20 mfd @ 150V, 2x1 1/2" can. 29¢
- CAPACITORS, 100 mfd @ 450V, 4 1/2 x 2" can. ea. 49¢
- Famous Brand HC PLASTIC CAPACITORS
  - 10,000 mfd @ 15V. 95¢ □ 500 mfd @ 300V. \$1.95
  - 12,000 mfd @ 15V. 95¢ □ 50 mfd @ 450V. 95¢
  - 15,000 mfd @ 15V. 95¢ □ 450 mfd @ 450V. 2.95
  - 1.5 mfd @ 100V. 95¢ □ 200 mfd @ 500V. 2.95
  - 1,000 mfd @ 175V. \$1.49

### SOLA VOLTAGE REGULATORS

1000 VA. Input 95-130; output 115V, 60-cy. Removed from eqpt., very good cond. Type #30809, was \$135. **\$49.50**

BECKMAN HELIPOT **\$7.50**

10-turn, 1K, 5%. Orig. bag.

### CITIZENS BAND ANTENNAS

**\$8.10** MOBILE with mount and cable!

**\$9.75** BASE STATION COAXIAL

- Famous Brand TX-803, oil cap., 4 mfd. @ 600V. ea. 66¢
- ELECTRO-MOTIVE CM-19, 180 mmfd, ±2% silver mica. 10 for 40¢, ea. 5¢
- Famous Brand 5W5Q15, CM-19, 15 mmfd, 500V, ±10%. 10 for 40¢, ea. 5¢
- Famous Brand 51R20, CM-19, 820 mmfd, 500V, ±5%. 10 for 40¢, ea. 5¢
- Famous Brand 1W3S1, .01 mfd, 300V, ±20%. 10 for \$2.50, ea. 29¢
- Famous Brand CAPACITORS, MT1510, 10 mfd @ 150V. 16¢
- Famous Brand, silver micas, 5 mmf, 10%. 500V. ea. 2¢
- Famous Brand ELECTROLYTICS, 3x10 mmf @ 300V. ea. 56¢
- Famous Brand PAPERS, P116S1, .01 mfd @ 1600V. ea. 92¢
- Famous Brand ELECTROLYTICS, MTO210, 10 mmf @ 25V. 19¢
- Famous Brand HYPASS, .25 mfd @ 200V. ea. 62¢
- Famous Brand PAPERS, PD4P25, .25 mfd @ 400V. ea. 7¢
- MICA PADDERS, 65 to 300 pf, 500V. ea. 5¢
- MICA POSTAGE STAMPS, .005 mfd, 500V. ea. 2¢
- VERNIER DIAL DRIVE, #348, 1 1/2". ea. 75¢
- 10-FT. ALUMINUM MAST. ea. \$1.95
- RUBBER BUTTON BUMPERS. ea. 2¢
- AMPEREX 1N87 diode (equal to 1N60). Reg. 43¢. 15¢
- MICROSWITCH #11SM1 with 18" 3-lead wires. SPDT. Worth \$2.50. ea. 29¢
- RG-59/U COAX CABLES, Amphenol, Federal included, 1000-ft., 3500-ft., 5000-ft. rolls available. Was \$5 per 100-ft. 100-ft. \$3.75
- SELECTOR SWITCH, 2-cir. 11-pos. w/DIPST switch on rear deck. ea. 12¢
- Famous Brand TUBES, 9006. ea. 8¢
- Famous Brand TUBES, 958. ea. 21¢



### METERS

MARION: 2" 0-1 MaDC 0-2000 V scale. Reg. \$9.60. **\$2.95**

WESTON: 0-3 MaDC. Reg. \$8.80. **\$3.95**

MARION: 100 μAmp. 4" VTVM scale. Reg. \$13.60. **\$4.95**

### BRAND NEW PACIFIC Semiconductor 1N34A

LESS THAN COST **25¢** ea.

OTHERS SELL FOR 50¢ EA. QUANTITY LOTS FOR SCHOOLS • LABS AND • INDUSTRIALS

### SILICON DIODES!!!

similar to 1N305 Mfr's Cancellations—formerly \$1.49 **39¢** ea.

### CARLING SPST TOGGLE SWITCH WITH 18" LEADS **19¢** While They Last

### ASST. RESISTORS—100 in KIT A-B—Famous Make 5% 10% **89¢** Lowest Price Anywhere

FAMOUS BRAND 10 WATT RESISTORS 1300 ohms—5%—Reg. 36¢ ea. **8c** ea.

FAMOUS BRAND PW4 4 WATT RESISTORS 5200 ohms—5%—Reg. 31¢ ea. **3c** ea.

FAMOUS BRAND TYPE MD MOLDED CERAMIC DISCS 100 for **\$3.00** 3c ea. ALL RMA VALUES—4.7 mmf to .01 mf REG. 15¢ ea.

### SOLA VOLTAGE REGULATOR TRANSFMR—ORIG. \$15 EXCELLENT CONDITION—PULLED FROM EQPT Type CVE7106, 385VDC @ 100 Ma. **\$9.95** 6.3V-3A, 5V-2A. While they last!

#### CLIP OUT AND MAIL

To: MASTER ELECTRONICS CORP. Dept. 666 189 High St., Boston, Mass.

- Place my name on your mailing list!
- Send bulletin for Citizens Band Transceiver!
- Send bulletin for Vacuum Tube Voltmeter!

NAME \_\_\_\_\_

STREET \_\_\_\_\_

CITY \_\_\_\_\_ ZONE \_\_\_\_\_ STATE \_\_\_\_\_

15-Day MONEY BACK GUARANTEE ON ALL MDSE.

HOW TO ORDER: Send check or M.O. including postage for shipping, excess postage will be returned. C.O.D. orders only 25% down; rated companies, net 30 days. Include postal office zone in address.

# MASTER ELECTRONICS

189 HIGH ST., BOSTON, MASS.



ESTABLISHED IN 1931

MAY, 1961

# FIELD

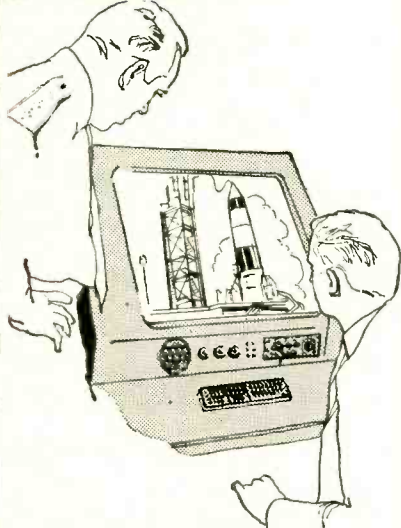

# ENGINEERS

## For Univac Missile-Guidance Computers

Field engineers are now being selected for maintenance assignments on ultra-reliable Univac missile-guidance computers and other military electronic data processing systems.

Openings involve maintenance of the Univac ICBM guidance computer, first of its size to be completely transistorized.

Applicants must have at least 2 years of formal education in Electronics with 3 or more years in maintenance or maintenance-instruction. Experience should be associated with complex electronic equipment such as TV, radar, sonar or digital computing systems.

Before assignment, you receive 2 to 6 months training at full pay in our St. Paul, Minnesota, laboratories. Benefits include company paid life insurance, hospitalization, medical and surgical benefits, relocation expenses and living allowances at field sites.

Openings also for qualified instructors with backgrounds similar to above.

Send complete resume of education and experience to:

**R. K. PATTERSON**, Dept. Q-5

**Remington Rand**  
**Univac**

Division of Sperry Rand Corporation  
2750 West 7th St., St. Paul 16, Minn.

sion type tweeter with phase-correction chamber. 2 crossovers. 5-lb. magnet of specially designed Magloy X. Frequency response 30-20,000 cycles. Free air resonance 35 cycles. Program power capacity 50 watts.—Allied Radio Corp., 100 N. Western Ave., Chicago 80, Ill.

**LOUDSPEAKER, Citation X**, preassembled, handles 35 watts integrated program material.



Externally fused. 20 x 14 $\frac{1}{4}$  x 36 $\frac{1}{2}$  in. 70 lb.—Harman-Kardon, Inc., Ames Court, Plainview, N. Y.

**SPEAKER ENCLOSURE, model 128**. 8 inches with vented ports. For horizontal or vertical



use. 9 x 11 x 19. Oiled walnut, hand-rubbed mahogany, blond or ebony.—Rockford Special Furniture Co., 1803 W. Belle Plaine Ave., Chicago 13, Ill.

**HI-FI SPEAKERS SYSTEM, L-1**, for vertical or horizontal bookshelf use. 15 $\frac{1}{4}$  x 9 $\frac{1}{4}$  x 8 $\frac{1}{2}$  in.



12 lb. Nominal impedance 4-8 ohms. Range 50-14,000 cycles.—PACO Electronics Co. Inc., 70-31 84th St., Glendale 27, N. Y.

**FM TUNER AMPLIFIER, model 510**. 20 watts power. 2 broad-band if stages, dual limiter and

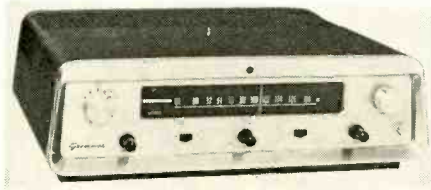

ratio detector.—Grommes Div. of Precision Electronics, Inc., 9101 King Ave., Franklin Park, Ill.

**FM TUNER-CONVERTER, Realistic**. Converts existing AM car radios to FM. 7 tubes, 12-volt



operation, cascaded rf amplifiers, vernier tuning. 7 x 3 $\frac{3}{8}$  x 5 $\frac{1}{2}$  in.—Radio Shack Corp., 730 Commonwealth Ave., Boston 17, Mass.

**10-WATT PA AMPLIFIER, model KN-3010**, for carnivals, bazaars, auctions and sales demonstrations. Frequency response  $\pm 2$  db, 70-10,000 cycles. Output impedances 4, 8, 16 and 500 ohms plus 70.7-volt tap. Tape output jack, single mike

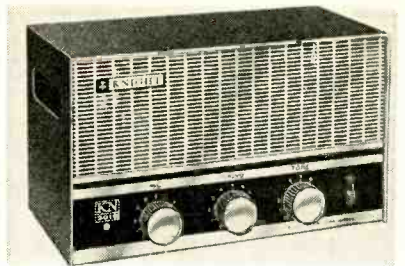

and phono inputs. 6 $\frac{1}{2}$  x 10 x 5 $\frac{1}{2}$ .—Allied Radio Corp., 100 N. Western Ave., Chicago 80, Ill.

**TUBE TESTER, model 600 Dyna-Quik**, tests all old and new TV and radio tubes, including nuvistors, new 10- and 12-pin tubes and Euro-

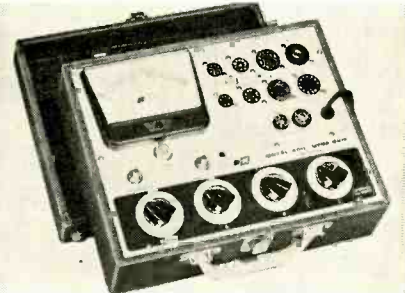

pean hi-fi tubes for shorts, grid emission, leakage and gas. 8 $\frac{1}{2}$  x 11 x 4 $\frac{1}{2}$  in.—B&K Mfg. Co., 1801 W. Belle Plaine Ave., Chicago 13, Ill.

**PORTABLE BEAMER** for testing and reju-



venating faulty and weak TV tubes. Tests for filament condition, element continuity by mutual conductance method, shorts, emission, grid cutoff and grid control, cathode test. Burns out shorts.—Teletronics Co., Ambler, Pa.

**VARIABLE AC BENCH SUPPLIES, models 1073 and 1078**, for production-line testing, quality control and service work. Kit and wired. Output 0-140 volts ac from 120-volt ac line. Current ratings 3 amps for 1073, 7 $\frac{1}{2}$  amps for 1078. Ammeter ranges 0-1 and 0-3 amps for 1073, 0-2 $\frac{1}{2}$



and 0-7 $\frac{1}{2}$  amps for 1078.—EICO (Electronic Instrument Co., Inc.), 33-00 Northern Blvd., Long Island City, N. Y.

**MULTI-PROBE** combines dc, ac/ohms, rf and low-capacitance probes. Rotating probe

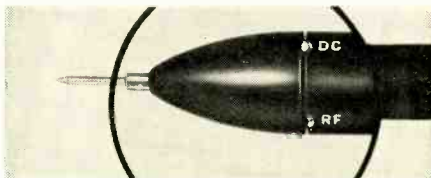

head with detent action for selection of desired function with  $\frac{1}{4}$ -turn.—Mercury Electronics Corp., 77 Searing Ave., Mineola, N. Y.

GRID-DIP METER KIT, model G-15, acts as variable frequency oscillator covering 400 kc to



250 mc in 8 bands and absorption wavemeter over these frequencies. 2 3/4 x 7 1/2 x 2 1/2 in. 3 lb. PACO Electronics Co. Inc., 79-31 84th St., Glendale 27, N. Y.

DUAL BIAS TV SUPPLY. Can be used as single



0-20-volt dc supply or as dual 0-20-volt dc supply.—Sencore, Addison, Ill.

ALL-WAVE GENERATOR, model 100, kit or wired. Combines Wienbridge audio generator and +1% Colpitts rf generator. At 20 to 20,000 cycles;



rf 100 kc to 330 mc. Metered and cathode follower outputs. Socket for crystal marker. Vernier tuning. 12 x 5 3/16 x 8 1/2 in.—Radio Shack Corp., 730 Commonwealth Ave., Boston 17, Mass.

TOGGLE SWITCH. Subminiaturized to 1/2 x 3/8 x 1/4 in. Rated at 5 amps at 115 volts ac. Hand-

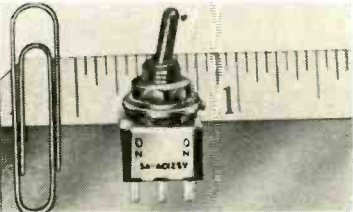

dles up to 100% overload.—ALCO Electronic Products, Inc., 3 Wolcott Ave., Lawrence, Mass.

WIRE STRIPPING AND SOLDERING TOOLS. Stripper with 4 cutting edges for most-used wire



sizes. Soldering tool forked for removing and soldering wires in tight quarters.—General Electric Co., Distributor Sales Operation, Owensboro, Ky. END

All specifications from manufacturers' data.

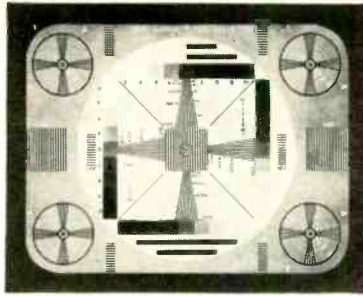

## TV TIPS FROM TRIAD

"—and you can see the 'glitch' on the trailing edge of horizontal sync," said Bill as he pointed to the offending interloper on the scope pattern. "Now, let's review: You're worried about your procedure because of the days you've lost on this job with multiple trouble. It loses horizontal hold on change of channels, or on some station switches, but it's perfectly stable otherwise. It has a slight 'S' in the vertical raster and a variable sync buzz in the audio. Now, what have you done so far?"

"What haven't I done?" muttered Joe under his breath, "so far I've shunted the electrolytics with good units of greater capacity than the originals, I've rebuilt the sync separator, AFC, and horizontal oscillator, with new parts and realigned the sound detector, all with no results."

"Sounds a little long on 'shotgun' and a little short on planning," commented Bill, with a twinkle in his eye. "since the 'glitch' shows up at the video detector it's very likely introduced in the tuner because of poor bypass. The 'S' in the vertical is also indicative of poor bypass, and you may have been fooled by trying to shunt a multiple unit like that four section electrolytic. Install a new high quality electrolytic and I'll wager that your buzz and 'glitch' will disappear. That spike is getting in at the tuner and looks just like sync to the sync separator.

"Whenever you change channels or the station switches in a way that interrupts sync, the AFC system locks in on its own reference pulse and 'hold' is not only lost, but actually locked out if the circuit incorporate a keyed AGC system.

"The hardest lesson I had to learn was to discipline myself to determine the basic problem, and then, one by one, repair the obvious. This meant not only taking positive steps with the filter system, but also not worrying about shading in the raster until I had replaced the covers on the cage or IF strip. If I fixed the visible problems, one at a time, the mysterious elements seemed to take care of themselves, or become easy to identify."

\* \* \*

MORAL: Many a Professional Television Man has had to replace a flyback or other component before he could determine the original reason for receiver failure. "Multiple trouble" is the theme of PTM #4 which will be mailed to people on our mailing list in the near future. If you are not on our mailing list, you can be by writing to **Renewal Division, Triad Transformer Corp.**, 4055 Redwood Ave., Venice, Calif.

## ARROW T-25 Low Voltage Wire STAPLE GUN

TAKES 3 STAPLE SIZES:

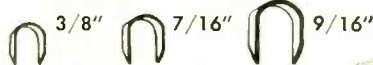

For faster, safer, more secure fastening of telephone wire, intercom wire, bell wire, thermostat wire, radiant heating wire, Hi-Fi, TV & radio wire — or any other LOW VOLTAGE WIRE up to 1/4" in diameter. Tapered striking edge gets into close corners!

AT YOUR JOBBER  
— Write for Literature

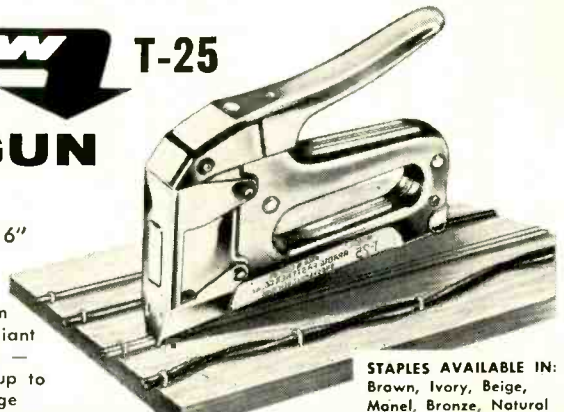

STAPLES AVAILABLE IN:  
Brown, Ivory, Beige,  
Mauve, Bronze, Natural

**ARROW FASTENER COMPANY, INC.**

1 Junius Street • Brooklyn 12, N. Y.

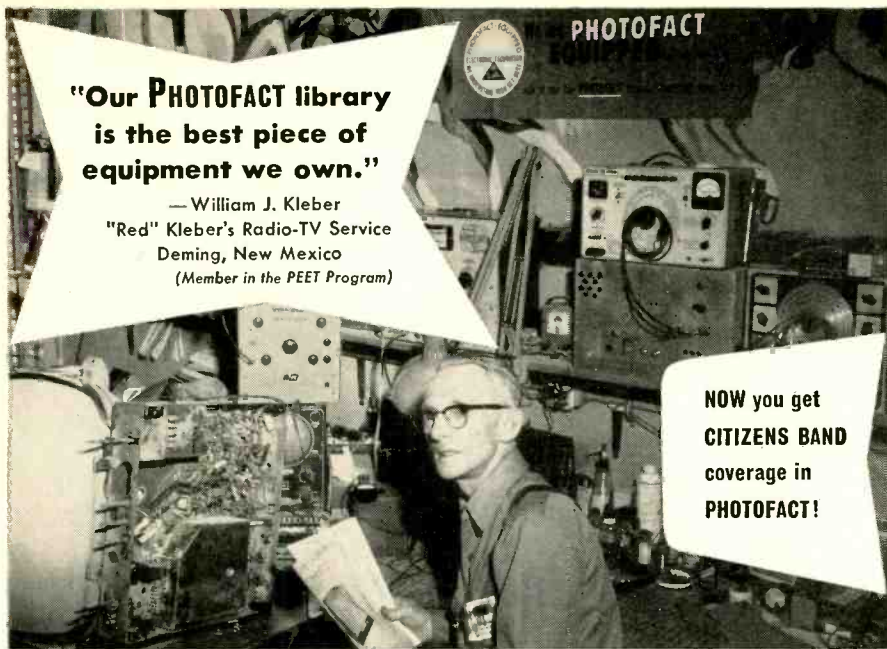

## Service Technicians! YOU EARN MORE... YOU RATE with the public when you own the PHOTOFACT® service data library!

You enjoy maximum earnings as the owner of a complete PHOTOFACT Service Data Library! It's inevitable, because no matter how expert you are, you can always *save more time on any job, get more jobs done daily*—EARN MORE, DAY IN AND DAY OUT...

What's more—as the owner of a complete PHOTOFACT Library, you know your customers' sets *best*. You can actually show each customer you have the PHOTOFACT Folder covering his very own set. Result: You command public respect and acceptance which paves the way to more business and earnings for you.

### HOW TO STAY AHEAD...

Yes, the truly successful Service Technicians are those who own the complete PHOTOFACT Library, who can meet and solve any repair problem—faster and more profitably. And these men *keep ahead* because they're on a Standing Order Subscription with their Distributors to receive all new PHOTOFACTS as they are released monthly. (They're eligible for the benefits of membership in PEET, too—see below!)

**ONLY \$10 DOWN** puts the complete PHOTOFACT Library in your shop—and you have up to 30 months to pay. See your Sams Distributor today, or write to Howard W. Sams

**NOW IS THE TIME TO JOIN**

**"PEET"**

#### THE POWERFUL NEW PROGRAM FOR QUALIFIED TECHNICIANS

If you now own a PHOTOFACT Library or plan to own one, you can apply for membership in "PEET." It's the first industry program really designed to build powerful public acceptance for the Service Technician who qualifies. Builds enviable prestige and business for its members. Benefits cost you absolutely nothing if you qualify. Ask your Sams Distributor for the "PEET" details, or mail coupon today.

**HOWARD W. SAMS & CO., INC.**  
1726 E. 38th St., Indianapolis 6, Ind.

- Send me full details on the new "PEET" Program.  
 Send full information on the Easy-Buy Plan and Free File Cabinet deal.  
 I'm interested in a Standing Order Subscription.  
 I'm a Service Technician  full-time;  part-time

My distributor is \_\_\_\_\_

Shop Name \_\_\_\_\_

Attn: \_\_\_\_\_

Address \_\_\_\_\_

City \_\_\_\_\_ Zone \_\_\_\_\_ State \_\_\_\_\_

TECHNICIANS'

NEWS

### FRTSA MEETS ON SERVICE BILL

*Harrisburg, Pa.*—The Federation of Radio-Television Service Associations of Pennsylvania held an open meeting on the proposed radio-television technician's licensing law. The meeting was open to all technicians and State Senators and Representatives. Representatives of the Department of Public Instruction, Department of Revenue and Attorney General's Office were invited to attend.

### LABOR COSTS vs SHOP RATES

The Federal Government, in one of its many aids to small business, has stated that to operate a successful service business a shop should charge 2½ to 3 times the basic wage rate paid to the repairman.

Current union scale in the Seattle area is \$3 per hour with an automatic increase to \$3.10 per hour next October first. Most employers figure that about 15% additional is their cost of vacations, holidays, payroll taxes, industrial insurance, etc. Really competent technicians are paid premium wages over and above this basic scale in most shops.

Take the basic union scale, which even employers should figure as their own minimum wages. We find by applying the Government recommended formula that hourly rates charged to the customer should be from \$7.50 to \$9 per hour. Compare this with other services—call your plumber, your oil burner repairman, your electrician and your auto mechanic, and see if these going rates are out of line with comparable services. Check with your own accountant who probably has a good idea of your own costs of doing business.

The hourly shop rate is generally conceded as the minimum home call rate and for each trip when pickup and reinstallation is required.—*TSA Service News*

### TESA-MILWAUKEE MEETS

*Milwaukee, Wis.*—Featured speaker at a recent meeting was Vince Suhajda, vice president and general manager of Stolz-Wicks, Inc. During his talk, he brought out that at present there are over 300,000 TV service dealers in the country, and also that gas stations, drugstores and chain stores are selling \$24,000,000 in receiving tubes annually!

Speaker for the TESA-Wisconsin Spring Convention June 24-25 was announced. It will be C. W. Harder, president of the National Federation of Independent Business Men.

Most important business for the eve-

ning was the nomination of officers.

So far, they are:

President: F. Schroeder, L. Zechel and Lee Cowen

Vice president: Dan Smith

Secretary: Jack Huron, J. Guendert

Treasurer: J. Zaniewski

### SRTT NEWS

*Van Nuys, Calif.*—Quite a group turned out to the regular Society of Radio & Television Technicians Inc. meeting. The subject "Tough Dogs" brought out the mangy pooches and some very interesting discussions involved. We were very happy to have as our special guest Bob Middleton. An interesting speaker as well as a writer, Bob plans to make his home in Southern California. Andrews Electronics, with the able direction of Bruce McColly, showed us RCA's new dot-bar generator. Capitol Electronics demonstrated Mercury's new substitution box and transistor diode checker.—*IPET*

### NEDA SAYS "HANDS OFF" ON LICENSING CONTROVERSY

*Chicago, Ill.*—Hands off is the policy of the National Electronic Distributors Association toward supporting or opposing service technician licensing. NEDA executive vice president Gail Carter says that several legislative bodies have asked NEDA for its views on licensing, but NEDA will not take sides.

### GLENDALE-BURBANK CSEA

Bob Chapman of Magnavox Corp. was guest of the evening at the regular meeting of the Glendale-Burbank Chapter of the California State Electronics Association. A complete report on licensing and the Professional Electronic Technicians Society Show in February rounded out a very full agenda.—*IPET*

### ABOUT COMPLAINERS

In establishing prices, warranty policies and other business procedures, do not overlook the apparently very common human factor of wishing to "complain." This is not to be confused with the occasional actual or (at least in the mind of the customer) reasonable complaint or inquiry.

The factor in question is typified by the many calls with which we are all familiar where the immediate reaction to a billing is "terrible" or "robbery" or "three times what it should be" and which appears as regularly in the case of the \$5 service call as it does in that of \$7.50, and is as loud in response to a billing for \$12.42 as it is at \$69.47.

It is apparently the same type of person who complains that "the set never did work right" or "it's worse than it was before" or "this never happened before you worked on it." A tweezer and scalpel are the most useful tools for finding out roughly what, if any, the troubles actually are.

The latest case in point was a voice on the TSA telephone wanting to "put a black mark" on one of our shops. "He is a crook" and "ran up a fantastic bill." He realizes that we are a "useless outfit" like the BBB. Refuses to give

his name, talk about the type of repair, the shop in question, or anything else that might possibly make sense. In other words, he wanted to complain. Period.

The point to be borne in mind is that while we most seriously consider and try to avoid or correct any remotely legitimate complaint, we also should try to recognize and make a proper distinction between this and the above situation.

It is the height of foolishness and unfair to ourselves, other shops and other customers, to turn our businesses upside down and make great concessions to try to placate these people who do not want to be pleased.—*TSA Service News*

### TESA SUMMIT COUNTY

*Akron, Ohio*—New officers for 1961 of the Television & Electronic Service Association of Summit County were installed at a recent meeting. The elected officers are: Charles Papp, president; Arthur Clough, vice president; Julius Klusty, secretary, and Joseph Lutz, treasurer.

Elected as director to represent the group at NATESA and TESA of Ohio conventions was Jerry Barkoukis. Alternate director is Jack Reitz.

### PASADENA CSEA

*Arcadia, Calif.*—The Pasadena Chapter of CSEA held a special dinner meeting at Rand's Restaurant. The guest of honor was Bruce V. Reagan, Assemblyman for the 47th District and a member of the Governmental Efficiency and Economy Committee considering licensing Bill AB 2829. Forty-four members and guests attended, and heard Ken Menzies, Bob Dumas, Ron Kealey, and Ben Leff explain the abuses and perils to the public under present unlicensed activities. Mr. Reagan held the closing spot with interesting comments of his own, and with advice on best ways of proceeding to CSEA's goal.—*IPET*

### LICENSE TEST STATISTICS

*Kansas City, Kans.*—Of the first 208 service technicians and dealers to take the examination for city licenses, 190 passed and 18 failed. Those who failed were given 30 days to take another test. All technicians in Kansas City must be licensed. An applicant must pass the test, then pay \$25 for a dealer license or \$10 for a technician license.

### NEW ASSOCIATION

*Hibbing, Minn.*—Word reaches us of another service association.

Range TV Service Association  
Box 782  
Hibbing, Minn.  
Alfred Schmidt, Secretary

We are happy to add this association to our growing list.

### A STORY WITH A PUNCH

The following editorial appeared in the TESA-Cleveland publication.

### SXXING IS BXLIXVING

Wx must apologizx for this xditorial but thx typxwritxr wx arx using has a dxfxctivx lxttxr. Thx missing lxttxr is thx onx bxtwxn "D" and "F" in

## IMPORTANT NEW SAMS BOOKS

new and needed

HOWARD W. SAMS

### Transistor Substitution Handbook

OVER 6500 DIRECT SUBSTITUTIONS!

Includes basing diagrams, polarity identifications and manufacturers for over 2700 transistor types... PLUS over 6500 direct substitutions for 2200 of these listings.



Here is the all-new reference prepared to minimize the problem of selecting suitable transistor replacements! Includes special section showing 668 American replacements for 263 Japanese transistors, PLUS a semiconductor diode and rectifier cross-reference directory (530 substitutions for 350 diodes). Text explains why substitution is possible; when it is appropriate and when not; what precautions to take when substituting. Data covers all types of transistors—U.S. and foreign; home entertainment, industrial and military \$7.50 types. 96 pages; 5 1/2 x 8 1/2". Only.....

### The Way to Added Service Income

#### How to Repair Small Appliances

Written by Jack Darr at the request of hundreds of TV-radio technicians. Tells how 15 everyday home appliances work and how to fix them. Covers toasters, shavers, irons, mixers, blenders, coffee makers, knife sharpeners, skillets, electric blankets, heating pads, fans, electric can openers, sewing machine foot controls, rotisseries, small motors, heating elements, thermostats, etc. Provides the know-how to take on profitable servicing of small appliances. 128 pages; 5 1/2 x 8 1/2". Only \$2.50



### For a Clear Understanding of Computers

#### ABC's of Computers

Want an inexpensive, basic introduction to computers, written in easy-to-understand language? This is the book for you—Allan Lytel tells you what computers are, how they operate, what they can be expected to do. Describes digital and analog computers, binary numbers, tube and relay switching devices, solid-state circuit devices, computer circuits, numbering systems, memory storage, counters, programming—the perfect introduction to this fantastically-expanding field. 128 pages; 5 1/2 x 8 1/2". \$1.95 Only.....



NEW! VOL. 12 AUTO RADIO MANUAL! Just out—coverage of 63 models produced in 1959-60. Complete Photofact® data. 160 pages; 8 1/2 x 11". Only..... \$2.95

### HOWARD W. SAMS & CO., INC.

Order from your Sams Distributor today, or mail to Howard W. Sams & Co., Inc., Dept. E-21 1720 E. 38th St., Indianapolis 6, Ind.

Send me the following books:

- Transistor Substitution Handbook (SSH-1)
- How to Repair Small Appliances (APP-1)
- ABC's of Computers (ABC-1)
- Auto Radio Manual, Vol. 12 (AR-12)

\$..... enclosed.  Send Free Parts List

Name.....

Address.....

City..... Zone..... State.....

IN CANADA: A. C. Simmonds & Sons, Ltd., Toronto 7 (outside U.S.A. priced slightly higher)

# ATLAS "Job Rated" P. A. SPEAKERS

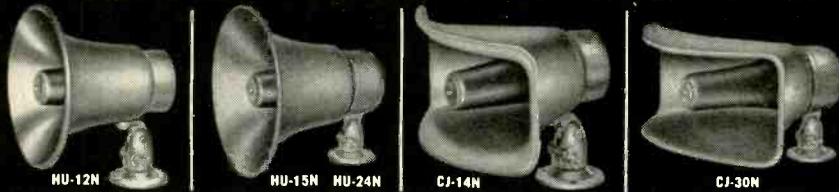

## There is an Atlas Speaker Ideally Suited for Every Job

All Atlas P. A. speakers are highly efficient, especially in the voice frequency range, providing the extra "punch" needed to override high level background noise. Most are 100% weatherproof; aluminum and diecast parts are treated with corrosion inhibitors, then finished in "stone hard" baked enamel. The CJ Cobra-Jector horns are constructed of nonresonant, indestructible fiberglass, and HU and TP speaker horns of aluminum, finished in gun-metal grey. The HU and TP speakers are particularly designed for efficient talkback operations. The peaked characteristics within the voice frequencies increase the sensitivity of these speakers as pickup devices.

All HU and CJ speakers are equipped with versatile "Versalock" . . . This rugged, reliable mounting bracket, completely adjustable both horizontally and vertically, provides positive locking in any position.

The DU-12 and DC-5, Atlas' renowned DeCor projectors, are styled to harmonize with any decor, modern or traditional.

Send for free catalog to Dept. RE-5

Model	HU-12N	HU-15N	HU-24N	CJ-14N	CJ-30N	CJ-44	TP-15N	TP-24N	DU-12	DC-5
POWER*	7.5 w	25 w	25 w	7.5 w	25 w	60 w	25 w	25 w	7.5 w	6 w
IMPEDANCE**	8 ohm	8 ohm	8 ohm	8 ohm	8 ohm	16 ohms	8 ohm	8 ohm	8 ohm	8 ohm
FREQUENCY C.P.S.	350-10,000	250-10,000	200-10,000	400-10,000	250-10,000	150-9000	250-10,000	200-10,000	400-10,000	120-7000
LENGTH OVERALL	7 1/4 in.	8 3/4 in.	12 in.	8 in.	1 1/4 in.	23" x 13"	16 1/2 in.	23 in.	14 in.	14 in.
BELL DIAMETER	7 1/2 in.	9 3/4 in.	11 1/4 in.	9 1/2" x 5 1/2"	14" x 6"	19 in.	9 3/4 in.	11 1/4 in.	7 in.	7 in.
NET PRICE	\$16.20	\$20.10	\$22.35	\$18.00	\$24.60	\$43.50	\$31.20	\$34.50	\$19.80	\$13.20

\*Input range limited to frequencies above horn cutoff \*\*All models available in 45 ohms at slightly higher prices



## ATLAS SOUND CORP.

1449 39th Street  
Brooklyn 18, N. Y.

In Canada:  
Atlas Radio Corp., Ltd.,  
Toronto, Ontario

## SERVICEMEN

### T.V. and RADIO TUBES ALL TOP NAME BRANDS

60-10-5% New—first quality—regular boxed—No Jobs—lots, closeouts or pull-outs. SEND for catalog. (Representatives wanted for all states. High commission.)

RADIO TUBE SPECIALISTS, Dept. C  
397—7th Ave., Brooklyn 15, N.Y.

### PACKAGE HI FI or SINGLE COMPONENTS You'll find our prices low and service fast.

Write for our quotation  
CENTER INDUSTRIAL ELECTRONICS, Inc.  
74-R Cortlandt Street, New York 7, N.Y.

## NEW! "Side Arm" Screw Driver by

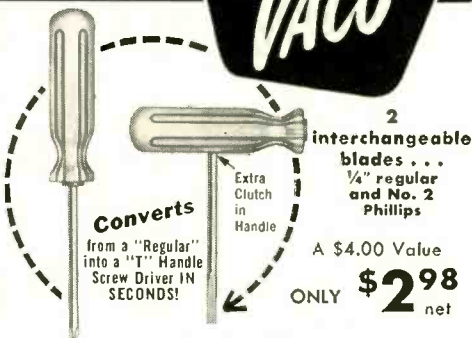

### No More "Fishing Around" For The Right Screw Driver

Everyone has wanted a high torque "T" handle screw driver . . . and VACO's "Side Arm" design now gives you the "T" handle plus regular . . . in ONE unit. The FREE BONUS gives you a complete fishing kit in addition . . . at no extra cost.

See Your Parts Jobber

VACO PRODUCTS COMPANY, 317 E. Ontario St., Chicago 11, Illinois

In Canada: Vaco-Lynn Products Co., Ltd., Montreal 1, Quebec

thx alphabxt. Wx havx had to improvix in ordxr to gxt our mxssagx across. In kxxping with thx attitudx of so many indxpndxnt sxrvix dxlxrs in thx arxa, "What's onx missing charactxr moxx or lxxs, thxrx arx still 25 othxr lxttxr to usx." "Lxt Gxorgx do it." No onx will vxvx miss onx littl lxttxr, or vxvn miss onx littl mxmbxr at an Associaxion mxxtng. "Our prxs-xnex at mxxtngs isn't vxry important, lxt thx othrx guys go and do all thx work, I'm just onx littl guy, thxy don't nxxd mx, and I don't nxxd thxm."

Yxs, I guxxs that many of thx "Hxxl Draggxrs" just do not sxxm to sxx thx light. Thxy do not rxalixz that wx arx trying to hxlp thxm. Xach littl charactxr is vxry vital, as is vxry lxttxr in thx alphabxt. Itxm or pxrxon, all arx nxxssary, and havx to work togethxr to makx sxxsx or to makx progrxxs. Isn't this a finx xxamplx?

Sinexrxly,

Gxorgx Srdjak, Sxerxtary  
Sxx you at our nxxt mxxtng? END

## 50 Years Ago

### In Gernsback Publications

#### HUGO GERNSBACK, Founder

Modern Electronics	1908
Wireless Association of America	1908
Electrical Experimenter	1913
Radio News	1919
Science & Invention	1920
Television	1927
Radio-Craft	1929
Short-Wave Craft	1930
Television News	1931

Some larger libraries still have copies of Modern Electrics on file for interested readers.

### In May, 1911, Modern Electrics

New Eiffel Tower Time Signals.

Solar Generator.

A Silicon Ticker, by Stanley Hyde.

Three-Slide Tuner, by William S. Wilder.

Tuning Coil of Fine Adjustment, by Harold Hermann.

Experimental Wireless Telephone

A Loose Coupler, by Walter Lean.

Wireless Across the U.S., by E. A. Mayne.



"It's a people clip."

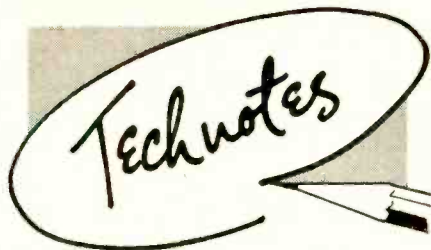

### RADIO ALIGNMENT

Occasionally a radio does not completely cover the lower end of the broadcast band and does not have a pad adjustment. The usual solution is to shift the intermediate frequency with a reduction in gain, or replace the oscillator coil. A simpler solution to this problem is to insert a small iron coil slug in the air-core oscillator coil. This will lower the oscillator frequency, extending it to the low end of the band. The slug should be wrapped with a piece of plastic tape to prevent shorting the coil terminals which extend into the coil's core. When the proper position of the slug has been determined, a small amount of service cement will keep it in place.—*Albert J. Krukowski*

### PHILCO T7 RADIOS

Every so often you'll run into one of these sets suffering from distortion on low-volume signals. Usually the trouble is at resistor R20. Simply unsolder the grounded end of this

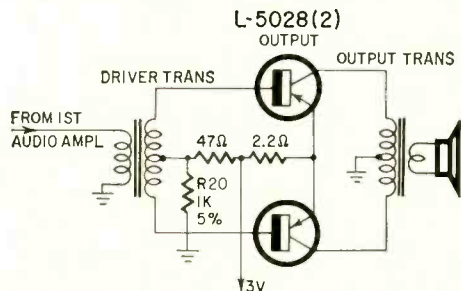

1,000-ohm unit. Then clean the ground point and resolder. Before unsoldering, you might check for a small voltage reading between the resistor lead going to ground and ground. Any reading at all confirms a poor ground connection.—*A. von Zook*

### CHECK CURRENT DRAIN

When I finish repairing a transistor radio, I always measure the total current drawn from the battery and make a note of it on the set's schematic. To insure a consistent reading, I make the measurement with the volume control turned down. This is a great aid when a similar model comes in for repairs. By comparing current readings, I can determine what type of trouble to look for.

For example, a shorted transistor or coupling capacitor will cause a large increase in current drain, and an open transistor or if coil will cause a decrease in current drain.—*Albert J. Krukowski*

### HEATH OM-1 SCOPE

In several cases this scope has shown considerable vertical deflection with the attenuator in minimum position and with no signal applied. Examination shows this to be 60-cycle sine-wave deflection.

### WE BUY TECHNOTES

Attention all service technicians! RADIO-ELECTRONICS will pay you \$5 for each acceptable item you send us for the Technote column. Acceptable circuit diagrams used to illustrate the item raise the basic price to \$9. Acceptable photos are worth \$7 each. We especially want Technotes on specific models (see the RCA 8BT-10K and Philco T7 here). So write up that tricky or interesting service job and rush it to: Technotes Editor, RADIO-ELECTRONICS, 154 W. 14 St., New York 11, N. Y.

## BY FAR WORLD'S MOST POWERFUL!

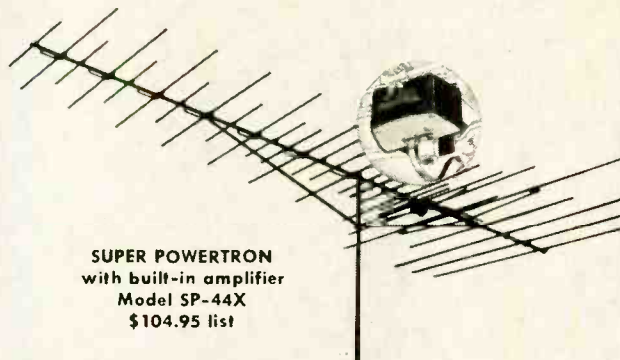

**SUPER POWERTRON**  
with built-in amplifier  
Model SP-44X  
\$104.95 list

## Winegard Electronic POWERTRON TV ANTENNA

This is the antenna the whole TV industry is talking about! 30 elements driving a built-in electronic amplifier . . . making the Super Powertron by far the world's most powerful TV antenna. Recommended for extreme distance reception or any installation where only the best is good enough. You'll be amazed when you try one!

### BUILT-IN AMPLIFIER ADDS 14 DB GAIN TO POWERTRON

Photo shows high impact housing that weather-proofs built-in Powertron amplifier. All components operate well below ratings. The amplifier plate circuit draws 15 milliamps at 120 volts, and we use a 170 volt, 65 mill rectifier. The filter condenser is rated at 250 volts . . . more than a double safety factor. The 6DJ8 frame grid tube has a normal life expectancy of 2 to 5 years . . . and is easily replaced if necessary. Antenna with amplifier includes compact remote power supply that converts 117 volt house current to 24 volts. Sends 24 volts up lead-in wire—greatly amplified signal comes down same wire.

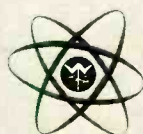
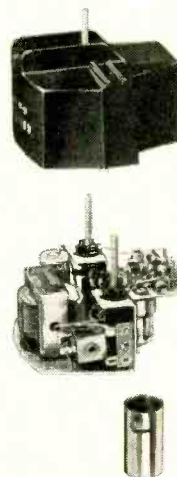

SEE YOUR DISTRIBUTOR OR WRITE

**Winegard**  
ANTENNA SYSTEMS

WINEGARD CO., 3013-5 Kirkwood Ave., Burlington, Iowa

This is caused by the introduction of a 60-cycle voltage on the cathode of the second stage of the vertical amplifier. The voltage develops because of a common path in the etched circuit consisting of the heater and cathode return to the chassis. The etched circuit has enough resistance to cause a voltage drop when the heater current flows through it. This voltage drop is in series with the cathode and appears as vertical deflection on the scope.

The remedy is to ground one end of a piece of hookup wire under one of the circuit-board mounting bolts and solder the other end directly to the heater pin on the socket. This provides a low-resistance path to the chassis for the heater and cures the stray deflection.—*Walter E. Weffenstette*

### SCOPE CHECKS RECTIFIER

If a full-wave power supply shows an increased hum level, a good check is to connect a scope to the cathode of the rectifier tube. You will normally see a peaked 120-cycle waveform. However, if the rectifier tube is approaching the

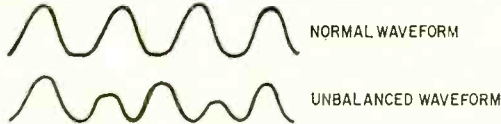

end of its life, you may observe that every second peak is higher. This is an indication that the two sections of the rectifier are unbalanced. Such a condition introduces a spurious 60-cycle component into the output. This is harder to filter than the normal 120-cycle wave and thus increases the hum level. When such a condition is observed, replace the rectifier tube, regardless of how it looks in a tube tester.—*Charles Erwin Cohn*

### RCA 8BT-10K

Audio distortion was ruining reception on this receiver, and our customer wanted it reduced to a reasonable level. Checking the circuit showed that R13, a 3,600-ohm 10% resistor off the center tap of the driver transformer, had gone

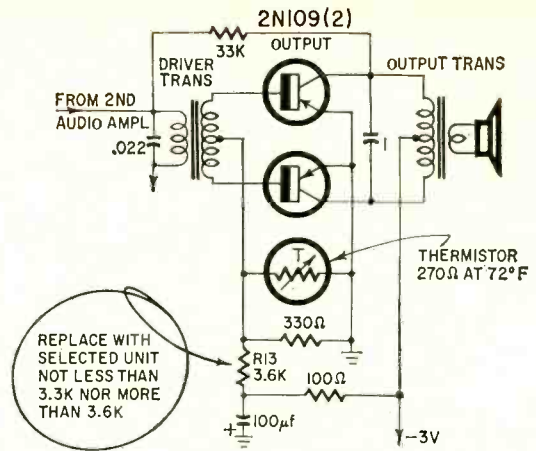

up in value. Replacing it with another 3,600-ohm unit reduced the distortion. In cases like this, according to RCA service data, the replacement resistor should be a selected unit that has a value no less than 3,300 or more than 3,600 ohms.—*M. L. Leonard*

### HIGH-VOLTAGE ARCING

With the summer months, and with them some high-humidity weather coming along, arcing tends to become a common TV trouble. The usual place this breakdown appears, because of a combination of dust and moisture, is at the anode button on the TV picture tube. Cleaning the button and about a 2-inch circle around it can eliminate this problem. A mixture of water and ordinary household detergent will do. After cleaning, connect the high-voltage lead and lay a 6-inch square of Saran wrap over the area.

Be sure that the set is turned off and the anode lead and button discharged to the chassis before starting the cleaning job. Dry the area with a paper towel before connecting the set again.—*Larry Steckler* END



**"MORE EFFICIENT CLEANING IS POSSIBLE!"**



**INJECTORALL COMPANY**  
Brooklyn 14,  
New York

...thru the use of  
**INJECTORALL TUNER CLEANER**

**CLEANING** ... our formulation gets contacts sparkling clean. **LUBRICATION** ... our spray leaves a lubricant as a protective coating. **NEEDLE APPLICATOR** ... the 6 inch Injectorall Needle is made of stainless steel, with a special fitting to prevent the needle from blowing out of the can.

Non-toxic, non-inflammable.  
6 oz. spray can with needle ... \$1.95 net.

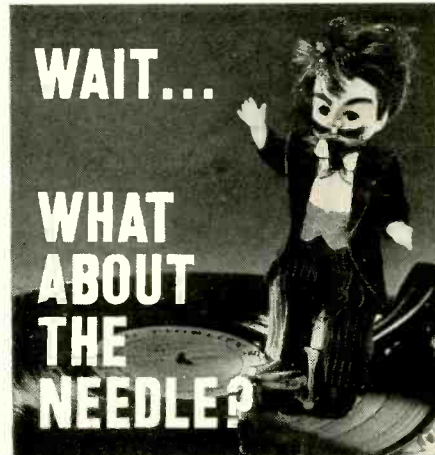

A Duotone needle, of course. You just repaired that phonograph. It's as good as new. Except ... did you remember to recommend a Duotone needle?

Like almost everybody else that customer of yours probably hasn't changed the stylus since he bought the phonograph. Tell him how a worn needle ruins expensive records, and tell him to buy a Duotone diamond needle. You'll make easy profits through easy sales.

Write for Free 1961 Duotone Needle Wall Chart. See your DUOTONE Distributor for Duotone needles.



**DUOTONE**  
COMPANY INC. KEYPORT, N. J.

Want to get ahead in **SERVICING?**

The G/L Technicians' Book Club can help you.

(See advertisement on page 116)

**Gernsback Library, Inc.**  
154 W. 14th St.  
New York 11,  
N. Y.



# NOTEWORTHY CIRCUITS



## CHRONISTOR

Many devices are used as elapsed-time indicators. Probably the commonest is the ordinary electric clock. Perhaps the most esoteric is a little device that exposes a piece of paper to light. The paper darkens slowly and elapsed time is read by comparing its color with a color chart.

Now there is a simple device that accurately *measures* time. It is the size of a cartridge fuse and comparatively inexpensive. This is the Chronistor made by Bergen Laboratories, Paterson, N.J.

The unit works on an electroplating principle and can be used to indicate the total number of hours during which any electrical device has been in operation. It requires only a tiny amount of current which is supplied by the unit being timed.

The Chronistor is essentially a miniature electroplating bath containing an anode, cathode and electrolyte (Fig. 1).

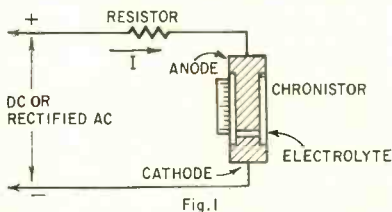

1). When dc passes through the electrolyte, metal ions are carried from the anode to the cathode. Obviously the length of the cathode and the anode will change as current is fed through the unit—the anode will get shorter while the cathode gets longer. This lengthening takes place at a constant rate and shows up against a time scale placed alongside the anode. This scale is calibrated in hours (Fig. 2).

Note the resistor in series with the Chronistor in Fig. 1. It limits current flow through the unit to 0.34 ma, since the resistance of the Chronistor is only about 200 ohms. This series resistor also helps maintain a constant current flow through the Chronistor.

An ideal use for these units would be a 1,000-hour 117-volt Chronistor connected to indicate the time a diamond phonograph needle has been in use. Such a timer would let the user know when he should replace the needle in

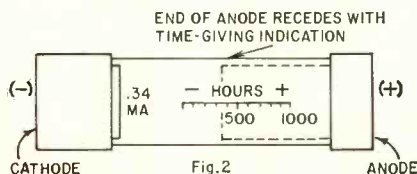

COMPARE

QUAM SPEAKERS

feature  
for  
feature

then decide  
for yourself which brand  
gives you the best value and the best  
performance in every speaker installation

	QUAM	BRAND A	BRAND B
ADJUST-A-CONE SUSPENSION to assure precise voice coil centering and alignment	YES	NO	NO
U-SHAPED POT to give you lowest possible energy loss and accurate magnet alignment	YES	NO	NO
ALNICO V MAGNETS	YES	YES	YES
HUMI-GARD CONE for greater heat and humidity protection in outdoor speakers	YES	NO	NO
AVAILABLE WITH SPECIAL VOICE COILS, SPECIAL FIELDS	YES	NO	NO
ADVERTISED TO THE PUBLIC	NO	YES	NO
LISTINGS IN PHOTOFACTS AND COUNTERFACTS to save you time, assure correct replacements	YES	NO	NO
THIRTY YEARS OF EXPERIENCE in engineering and manufacturing quality loudspeakers under same ownership	YES	NO	NO

Write

for your free copy of the QUAM General Catalog, listing the full line of QUAM speakers for radio-tv replacement, public address, and high fidelity. QUAM speakers are completely manufactured in the United States of America.

## QUAM-NICHOLS COMPANY

238 East Marquette Road • Chicago 37, Illinois

**60,000 SOLD IN 7 MONTHS! BIGGEST ASSORTMENTS EVER!**

**RADIO-TV PARTS BY THE POUND IN NEW... JUMBO PAKS!**

BUY FOR SCHOOLS & LABS. • SHARE WITH FRIENDS • SPLIT UP INTO ECONOMY PAKS

<b>SPECIAL TRUCK-LOADS</b> of manufacturers overruns	<input type="checkbox"/> One POUND <b>PRECISION RESISTORS</b> WORTH \$100	<input type="checkbox"/> One POUND <b>DISC CONDENSERS</b> WORTH \$90	<input type="checkbox"/> One POUND <b>CERAMIC CONDENSERS</b> WORTH \$85
<input type="checkbox"/> One POUND <b>HI-Q CONDENSERS</b> WORTH \$95	<input type="checkbox"/> One POUND <b>DISCS &amp; CERAMICS</b> WORTH \$75	<input type="checkbox"/> One POUND <b>Discs, Ceramics PRECISIONS</b> WORTH \$70	<b>BUY 4 PAKS &amp; PICK 5th FREE</b>

**\$3<sup>00</sup> per pound**

400-1000 pcs. per lb. A money-back guarantee. Clip out & mail.

**FREE GIANT BARGAIN CATALOG WRITE FOR YOURS!**

HOW TO ORDER: Include check or M.O. with sufficient postage; excess returned. C.O.D. orders, 25% down; rated, net 30 days. INCLUDE POSTAL ZONE in address.

**LEKTRON** 241 Everett Ave. CHELSEA 50, MASS.

Win with **EMC**



By far the **BEST VALUE** obtainable in either wired or kit form... compare and you'll agree "THE BEST BUY IS EMC."

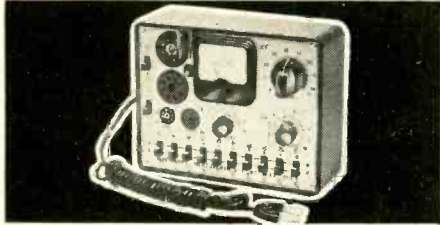

**EMC Model — 211 Tube Tester** — The smallest, lowest priced, domestic made tube tester on the market. It is completely flexible and obsolescent proof. It checks each section of multi-purpose tubes separately, checks all octal, loctal, 9 prong and miniature tubes for shorts, leakages, opens, intermittents as well as for quality. Quality is indicated directly on a two color meter dial using the standard emission test. Comes complete with instructions and tube charts in ring bound manual. Size 6 3/4" x 5 1/4" x 2 1/4" deep. Shipping weight: 3 lbs. Wired ..... \$22.90 Kit ..... \$14.90  
**CRT Picture Tube Adapter** ..... \$ 4.50

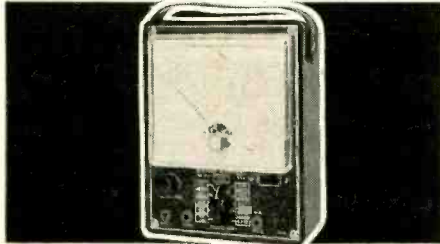

**EMC Model 109 — Voltmeter** — Features 20,000 OHMS volts DC sensitivity and 10,000 OHMS per volt AC sensitivity. Uses a 4 1/2, 40 microampere meter, with 3 AC current ranges, and 3 resistance ranges to 20 megohms. 5 DC and AC voltage ranges to 3000 volts and 3 DC current ranges; also 5 DB range.

**Model 109** — With carrying strap, Weight 2 lbs. 5 oz.; Size: 5 1/4" x 6 3/4" x 2 7/8" ..... \$26.95

**Model 109K** — Kit Form ..... 19.25

**Model HVT** — 30,000 Volt Probe for Model 109 ..... 7.95



**EMC Model 107A** — Peak to Peak Vacuum Tube Volt-Ohm Capacity Meter — 6" meter cannot burn out — entirely electronic. Measures peak to peak AC voltages to 2800 volts in 6 ranges. Measures capacity in 6 ranges from 50 mmfd to 5000 mfd. Measures resistance in 6 ranges from .2 ohm to 1000 meg. Measures DC volts to 1000 volts in 6 ranges. Input resistance to 16.5 megs. Wired ..... \$51.40 Kit ..... \$36.50

Yes, tell me more, send me **FREE** a detailed catalog of the Complete EMC Line. Dept. RE-561

NAME .....  
 STREET .....  
 CITY ..... STATE.....

**EMC** Electronic Measurements Corp.  
 625 B'way, New York 12, N. Y.  
 Ex. Dept., Pan-Mar Corp., 1270 B'way, New York 1, N. Y.

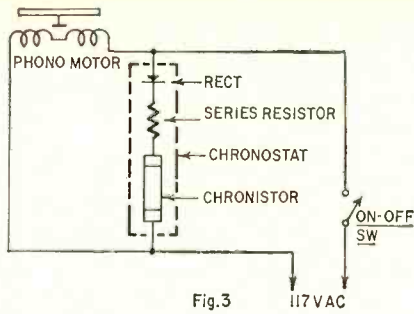

his set, thus avoiding damage to his record collection. For this application a Chronostat timer is available. It consists of a 1,000-hour Chronistor with a built-in rectifier and a series resistor. The unit is connected across the phonograph (Fig. 3) motor and thus indicates elapsed time only when the phonograph is being used.

### HEAVY DUTY AC-DC RELAY

Many applications about the home or lab require the use of a heavy-duty relay able to actuate circuits drawing hundreds of watts of power from the line. These are readily available from leading electronics warehouses, but they all come in either ac- or dc-operated form. Here is a simple-to-construct heavy-duty relay that will operate on either ac or dc and will handle up to 1,500 watts, depending on the type of snap-action switch employed.

Plan to mount all the parts on a

## NEW The Original "Strobolamp" by SWITCHCRAFT

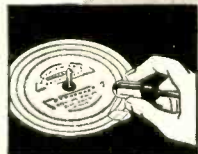
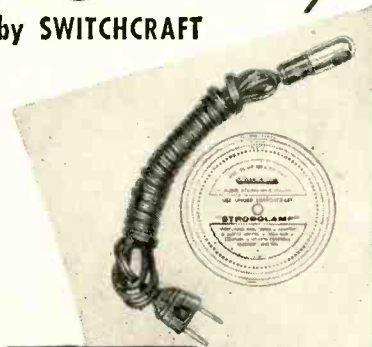

GET THE MOST FROM YOUR RECORDS

Incorrect turntable speeds cause Wow and Distortion. Check the speed of your turntable the easy and simple way.

"Strobolamp quickly tells you if 16%, 33 1/3, 45 or 78 rpm speeds are correct. A HI-FI NECESSITY.

Consists of stroboscopic disc and molded neon lamp with 6 ft. AC cord. Only \$1.95 list.

Send for Hi-Fi Catalog A-403. Contact your local Hi-Fi specialist or write factory for dealer nearest you.

**SWITCHCRAFT**

5579 N. Elston Ave., Chicago 30, Ill.

flat square metal base measuring about 3 5/8 x 1-15/16 inches, and at least 1/16 inch thick. Exact dimensions depend on the physical size of the snap-action switch as well as the actuating coil. Choose a switch having a leaf-spring-hinged action, such as the Unimax 2HBT1, and mount it firmly in the center near one end of the metal base (Fig. 1). Use washers or a nut to elevate the switch about 3/16 inch above the base plate. Construct a stop which will serve as a sensitivity adjustment by resting a bolt against the leaf spring. Use one or two nuts to lock the adjustment once it is made.

The actuating coil can be one salvaged from a telephone type relay, TX-3A (surplus market), or a spool can be made with a pair of fiber or plastic discs and a 1/4-inch soft-iron rod or bolt. The spool should be 15/16 inch long; the face of the spool is 12/16 inch in diameter. Fill the spool with as many turns as possible of No. 30 or 31 enamel-covered wire, and be sure to insulate the rod or bolt with one layer of cellophane tape or other soldered connections. Mount the coil near the switch with one end in line with the leaf spring. Adjust the position of the coil so that the switch is actuated just as the leaf spring touches the coil end. Later, finer adjustment can be made with the stop.

For both ac and dc operation, you will have to include in the circuit a low-cost power type transistor like the Olson X846 or Lafayette SP-147 strapped as a diode rectifier, and a 100-µf electrolytic. These are connected as shown in Fig. 2. Upon completing and testing the unit, house it in a suitable metal case and mount the transistor on the top. This will help dissipate some of the heat generated in

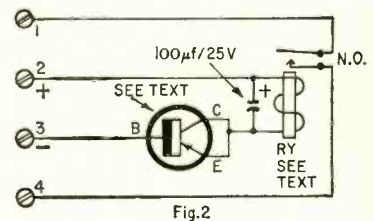
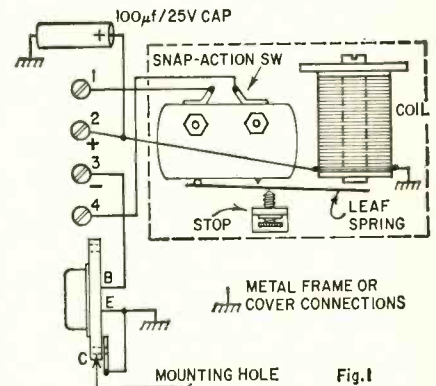

the transistor when the relay is used on ac. When soldering connections to the transistor, hold the terminals in heavy pliers to carry away the heat. For dc operation, you will have to observe the proper polarity.—Martin H. Patrick

# NEW TUBES and SEMI-CONDUCTORS

ANOTHER nuvistor triode leads off this month. It is backed up by a couple of ultra-fast switching transistors, a series of horizontal output tubes for TV, and a power rectifier with double filament and plate leads.

7895

This triode is another addition to the growing line of subminiature metal-cased nuvistors. It has an amplification factor of 64 and is intended for a variety of industrial applications. It can deliver high gain with low noise in such amplifier circuits as cascode, rf and if, on-off control and resistance-coupled. It also offers good stability as

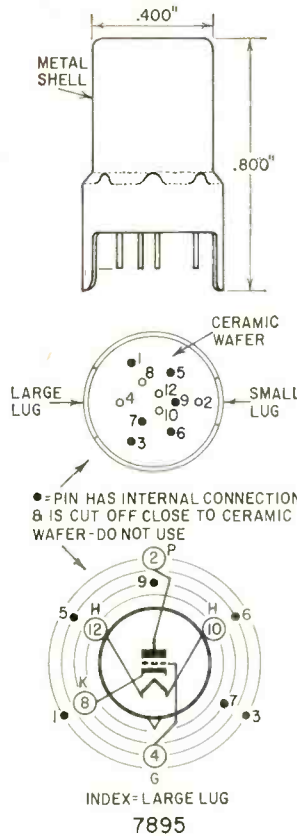

an oscillator from very low audio frequencies up into the uhf region. Note the unusual basing of this tube.

## Purchasing A HI-FI SYSTEM?

TIME PAYMENTS AVAILABLE

Up to 2 years to pay!

Send Us Your List Of Components For A Package Quotation

You Can Buy With Confidence AT AIREX

All merchandise is brand new, factory fresh & guaranteed.

Free Hi-Fi Catalog

**AIREX RADIO CORPORATION**

85-RE Cortlandt St., N.Y. 7, WO4 -1820

Jim Lansing\*  
Altec Lansing  
Electrovoice  
Superscope  
Hartley\* • Viking  
University • Jensen  
Acoustic Research  
Janzen  
Wharfedale  
USL Citizen Band  
Gonset\* • Hallicrafter  
Texas Crystals  
Concertone  
Bell • G. E.  
Weathers  
Harman-Kardon  
Eico • Pilot  
ESL  
Superscope  
Dual Changer  
Bogen • Leak  
Dynakit • Fisher  
H. H. Scott  
Thorens\* • Sherwood\*  
TEC • Roberts  
DeWald  
Sony • Tandberg\*  
Challenger  
Wollensak  
Garrard  
Miracord  
Glaser-Steers  
Rek-O-Kut  
Components  
Norelco • Conrac  
Fairchild  
Pickering • Gray  
Audio Tape  
Magnecord\*  
Artizan Cabinets  
Rockford Cabinets

\*Fair Traded



THIS is the microphone for mobile use

## THE TURNER 350C

Good performance on mobile operations — citizen's band, 2-way commercial radio and amateur radio — requires a microphone designed for mobile use. Tape recorder type mikes can't do the job. The Turner 350C is a reasonably priced, ceramic microphone especially designed for quality voice reproduction. DPST switch is wired for relay operation with easily reversible terminals to allow modification (if necessary). A wiring diagram is enclosed with each microphone. Hanger button and standard dash bracket are included for mobile rig mounting. Microphone furnished with 11" retracted (five foot extended) Koiied Kord. Response: 80 to 7000 cps. Output: -54 db. List price: \$16.80 complete. See your electronic parts distributor. He has the Turner 350C in stock.

THE **TURNER** MICROPHONE COMPANY  
933 17th Street NE  
Cedar Rapids, Iowa



World's Only 'Portable Recording Studio...'  
the all-in-one

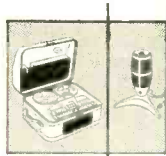

# Norelco®

CONTINENTAL '400'  
4-Track Stereo Tape Recorder

A recording studio in a suitcase—that's how Norelco '400' owners describe this most advanced (and most popular) self-contained stereo tape recorder. **VERSATILITY:** 4-track stereo recording and playback, as well as 4-track monophonic recording and playback, at any of its 3 speeds. **FREQUENCY RESPONSE:** at 7½ ips, 50-18,000 cps; at 3¾ ips, 50-14,000 cps; at 1½ ips, 60-7000 cps (yes, its response at 3¾ ips is actually equal to or wider than the response of most other machines at 7½ ips)! **PROFESSIONAL EXTRAS** (at no extra cost): mixing, monitoring, sound-on-sound facilities and the Norelco stereo dynamic microphone. **SIGNAL-TO-NOISE RATIO:** 48 db or better. **WOW AND FLUTTER:** less than .15% at 7½ ips. **CROSSTALK:** 55 db. **HEAD GAP:** .00012". **AUDIO FACILITIES:** completely self-contained, including dual recording and playback pre-amplifiers, dual power amplifiers and two Norelco wide-range, stereo-matched speakers (one in the detachable lid). For complete specifications, write to Norelco. In the meantime, see and hear the '400'. The recording studio you can carry is now available for immediate delivery.

High Fidelity Products Division  
NORTH AMERICAN PHILIPS COMPANY, INC. • 230 Duffy Avenue, Hicksville, L.I., N.Y.

## NEW MAGNIFYING LAMP FOR PRECISION WORK!

### Swing-O-Lite INSPECTOR

the best lamp you can use for miniature assembly work, bench work, blueprints and schematics, etc.

DEALER & DISTRIBUTOR INQUIRIES INVITED  
REPS WANTED—CHOICE TERRITORIES OPEN

Write for FREE CATALOG of complete line. Dept. RE-561

NAME.....  
STREET.....  
CITY..... STATE.....

Swing-O-Lite INC.

13 MOONACHIE ROAD, HACKENSACK, N. J.



MODEL M1  
(45" arm reach)

- 5" diameter precision polished magnifying glass
- 22 watt shadow-free fluorescent light
- Complete arm mobility for exact spot location
- Exclusive convenience electric outlet in base (optional extra)
- Choice of colors and mounts

SEE US  
IN  
BOOTH 873  
ELECTRONIC  
PARTS SHOW  
CHICAGO  
MAY 22-24

Instead of the normal arrangement of pins in a single circle, there are four concentric circles of pins. This is necessary because of the construction of the nuvistor (see diagram). The nuvistor is built up of concentric elements. Each element (except for the heater) has three supporting pins. Two are cut flush with the base wafer and are unused. The remaining one becomes the active pin for that element.

For example, looking at the basing diagram you will see that the innermost circle has two pins for the heater, both used. However, each of the other three circles has 3 pins spaced 120° apart. One pin in each circle is used, while the other two are merely supports for the internal structure of the tube.

Characteristics of the RCA nuvistor 7895 as a class-A1 amplifier are:

$V_{btr}$	6.3
$I_{btr}$ (ma)	135
$V_p$ supply	110
$V_G$ supply	0
$R_k$ (ohms)	150
$\mu$	64
$R_p$ (ohms)	6,800
gm ( $\mu$ mhos)	9,400
$I_p$ (ma)	7
$V_G$ (for 10 $\mu$ a $I_p$ )	-4

### 2N743, 2N744

Ultra-fast silicon n-p-n switching transistors made by the epitaxial manufacturing process, these two new units are claimed to be at least twice as fast

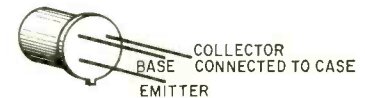

2N743, 2N744

as any other commercially available silicon switching transistor.

Comparing the 2N743 with a conventional silicon switching transistor (2N706) in equivalent circuitry, the 2N743 switches in one-half the time at current levels of 10 ma and one-quarter the time at 100 ma.

Maximum ratings of these Texas Instruments transistors are:

$V_{CE}$	12
$V_{CB}$	20
$V_{EB}$	5
$I_c$ (continuous) (ma)	200
$P_{total}$ (mw)	300

### 6GW6, 12GW6, 17GW6

A series of beam power tubes in glass-octal envelopes designed for use as horizontal deflection amplifiers in high-efficiency TV deflection circuits. The following characteristics make it possible for these tubes to provide full deflection for systems using wide-angle or high-ultra-voltage picture tubes:

▶ Excellent knee-current characteristics—the 'GW6's can deliver a 390-ma plate current with zero bias and only 60 volts on the plate.

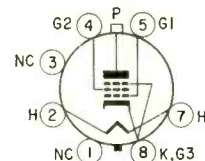

6GW6, 12GW6, 17GW6

- ▶ High ratio of plate current to grid-2 current.
- ▶ High voltage and dissipation ratings.

All three tubes have identical electrical characteristics except for heater ratings. The 6GW6 has a 6.3-volt 1.2-amp heater; the 12GW6 a 12.6-volt 600-ma controlled-warmup heater, and the 17GW6 a 16.8-volt 450-ma controlled-warmup heater.

Maximum ratings of these RCA tubes in horizontal deflection amplifier service:

$V_p$ supply (boost plus dc pwr)	770
Peak positive pulse	6,500
Peak negative pulse	1,500
$V_{G2}$	220
$V_{GL}$	-55
$V_{G1}$ (peak negative pulse)	330
$I_k$ (peak) (ma)	550
(average) (ma)	175
$V_{G2}$ (input) (watts)	3.5
$P_p$ (watts)	17.5

### 5DJ4

A high-vacuum power rectifier with double filament leads and double plate

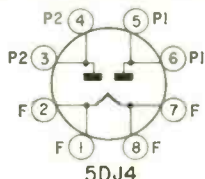

5DJ4

leads which reduce the current through each lead to one-half the current of single-lead tubes. Electrically, the 5DJ4 is identical to the 5U4-GB and may be used for the same applications.

Typical operating conditions and characteristics of the Tung-Sol 5DJ6 as a full-wave rectifier with capacitor input filter are:

$V_p$ supply (rms) (each plate)	300	450
$R_{plate}$ supply (each plate) (ohms)	21	67
Input filter capacitor ( $\mu$ f)	40	40
$I_{output}$ (dc) (ma)	300	275
$V_{output}$ (dc)	290	460

### 7534

A premium power pentode that incorporates two frame grids, one a control grid, and the other a screen grid. It is an output pentode designed for use as a wide-band amplifier, cathode follower, series stabilizer in electronic power supplies and as an output tube in class-B push-pull circuits.



The Amperex 7534 has a transconductance of 26,000  $\mu$ mhos. Cathode current is 300 ma, making the tube suitable for use as a TV deflection amplifier.

In power amplifier circuits—push-pull class-B—the tube can deliver up to 60 watts. Total harmonic distortion is 5% and with feedback can be reduced to less than 1%. **END**

## now for the first time A COMPREHENSIVE COMPILATION OF 4500 DIRECT TRANSISTOR SUBSTITUTIONS

### INTERNATIONAL TRANSISTOR SUBSTITUTION GUIDEBOOK

(Direct Substitutions Only) by Keats A. Pullen, Jr., Eng. D.

Only an engineer with the experience of the author—Keats A. Pullen Jr. (member of the scientific staff, Ballistics Research Laboratories, Aberdeen Proving Grounds) could possibly have compiled the transistor substitutions data contained in this guidebook. Everyone who works with transistors in repairing, maintaining or designing—must have this time-saving tool. Here's why:

#### COMPLETE AND COMPREHENSIVE

International in coverage, it lists 4500 direct substitutions comprised of American, Japanese, British, French, German, Dutch and Italian transistor types. Includes both triodes and tetrodes.

#### PROVIDES DIRECT SUBSTITUTIONS ELECTRICAL AND PHYSICAL

Not only are the direct electrical substitutions shown, but case styles and dimensions also are given for maximum substitution flexibility.

#### COVERS TRANSISTORS USED IN ALL TYPES OF ELECTRONIC EQUIPMENT

The guidebook is universal in its application. It covers transistor substitution for radios, television receivers, all sorts of military, industrial, communication and computer equipments.

#276, 64 pp. \$1.50

### NEW RIDER BOOKS

**CITIZENS BAND RADIO** by Allen Lytel. This book has a three-fold purpose: to tell the story of citizens band radio equipment to the prospective buyer, to the user and to the man who will repair it. For those new to the subject, early chapters describe the historical development of citizens band radio, its applications, classifications, and types of equipment. FCC Rules and Regulations, important to the citizens band user, are discussed. There is the detailed discussion on different types of transmitting and receiving equipment; comparison of them with emphasis on single-channel and multi-channel transceivers and receivers. Other highlights are: descriptions of portable units, kits and standard transceivers, antennas and power supplies. The installation and repair of citizens band radio equipment is covered in detail. #273, \$3.90.

**FILTERS & ATTENUATORS**, Edited by Alexander Schure, Ph.D. (No. 36 in the Electronic Technology Series.) This book will make filters, attenuators—their functions, the wide variety of types, circuitry and applications understandable. Both narrative and mathematical presentations are used. The characteristics of the capacitor-input type filter in power supplies is analyzed with problems and solutions. Numerous other filter types used in power supplies also are discussed in similar manner. Audio and video filters, wave filters and specialized types, are covered thoroughly—a chapter being devoted to each.

The text devoted to attenuators and equalizers is illuminated by means of numerical examples and solutions. The calculations include the determina-

tion of their component parts. Variable attenuators are also covered, as well as phase equalizers. This is an outstanding technical text for those interested in the configuration and analysis of filter and attenuator circuitry. Review questions appear at the end of each chapter. #166-36, \$2.25.

**TRANSFORMERS**, Edited by Alexander Schure, Ph.D. (No. 37 in the Electronic Technology Series) The transformer as it is used in electronic equipment is examined in a highly analytical manner with numerous mathematical examples. The examples give the reader a theoretical as well as a practical view of the transformer. Starting with a discussion of the magnetic principles underlying the operation of the transformer, it progresses to transformer design and construction, discussing efficiency and coil currents, flux density, core losses, leakage inductance, distributed capacitance and current as well as voltage waveforms. Power transformers are studied in full depth from the simple color coding of the leads to the relation of power transformers to rectifier-filter systems. Audio transformers are covered with emphasis on such important topics as impedance ratios, broadband audio transformers and transistor transformers. In the area of high frequency transformers, the text treats the tuned and untuned primary and secondary windings in different combinations. It discusses in detail such special transformer items as saturable reactors, voltage regulating transformers, video transformers, pulse transformers and balancing transformers (baluns). Review questions appear at the end of each chapter. #166-37, \$2.00.

We guarantee satisfaction or return to us within 10 days for a full refund.

These and many other Rider titles are available at bookstores, electronic parts distributors, dept. stores or direct. Send for new catalog. RE-5



JOHN F. RIDER PUBLISHER, INC., 116 West 14th Street, New York 11, N. Y.  
Canada: Chas. W. Pointon, Ltd., 66 Racine Rd., Rexdale, Ont.  
Export: Acme Code Company, Inc., 630 9th Ave., N. Y. C.

PHONE  
ED 9-9653

\$7.50  
plus parts,  
C.O.D. and postage charges

90 DAY  
WARRANTY

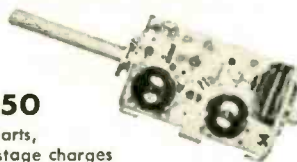

### Precision Tuner Service

ALL TYPES T.V. TUNERS REPAIRED AND ALIGNED TO FACTORY SPECIFICATIONS ON CRYSTAL-CONTROLLED SWEEP GENERATORS

24-HOUR SERVICE ON MOST TUNERS

UHF - VHF COMBINATIONS — \$13.50

Dept. RE

See your local distributor or send to:

P.O. Box 272, 1200 S. Walnut  
BLOOMINGTON, INDIANA

State make and model. Send  
all parts, tubes and shields.

Now — 24-Hour Tuner Service

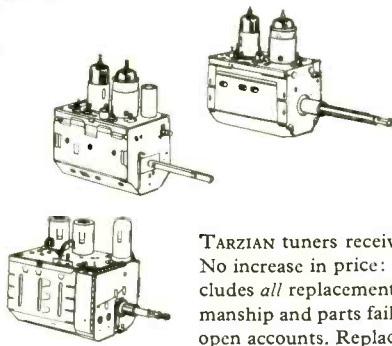

**Tarzian Offers 24-hour Direct Factory Service on TUNER REPAIRS . . . \$8.50**

TARZIAN tuners received one day will be repaired and shipped out the next. No increase in price: \$8.50 per unit and \$15 for UV combinations. That includes *all* replacement parts, and a 6-month warranty against defective workmanship and parts failure due to normal usage. Tuners repaired on approved, open accounts. Replacements available at low cost on tuners beyond practical repair.

Tarzian-made tuners easily identified by this stamping. When inquiring about service on other than Tarzian-made tuners, always give tube complement . . . shaft length . . . filament voltage . . . series or shunt heater . . . IF frequency . . . chassis identification. And, allow a little more time for service on these tuners. Use this address for fast, factory repair service:

SERVICE MANAGER • TUNER DIVISION Dept. C



**SARKES TARZIAN INC**

east hillside drive  
bloomington, indiana  
edison 2-7251

Mfgs. of Tuners, Semiconductors, Air Trimmers, FM Radios, Audio Tape, and Broadcast Equipment

**CONVERT TO COLOR TV**

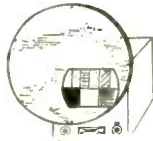

**COLODAPTOR**—A simple 10-tube circuit and rotating color wheel converts any size B & W TV to receive compatible color TV.  
**COLODAPTOR** — Easily attached to any TV set, does not affect normal operation, often built from parts experimenters have on hand, **BRILLIANT COLOR!**

Complete booklet—gives theory of operation, all construction details, schematic, and sample color filters.  
**ONLY \$1.95**  
Essential Parts Kit—All Special Parts—Coils, Delay Line, Crystal, Color Filters  
Up to 16" Sets— **\$19.95** 17" and Larger **\$20.95**  
Other Kits, Wired Chassis, Motors Available  
**COLODAPTOR**  
1798 Santa Cruz, Menlo Park, Calif.

**A NOTE TO THE HI-FI BUYER**  
AIR MAIL us your requirements for an **IMMEDIATE LOWEST PRICE QUOTATION** Components, Tapes and Recorders  
**SHIPPED PROMPTLY AT LOWEST PRICES**  
**WRITE TODAY FOR FREE CATALOG**  
**AUDIO UNLIMITED**  
190-R Lexington Ave., New York 16, N. Y.

**TAPE RECORDERS**



**HI-FI COMPONENTS SLEEP LEARN KITS**  
Unusual Values Free 1961 Catalog  
**DRESSNER**  
1523 RE Jericho Tpke, New Hyde Park, N.Y.

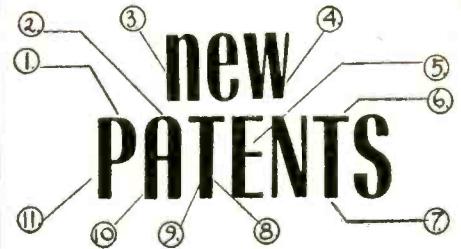

**IMPROVED COMPRESSION SPEAKER**

Patent No. 2,907,837

Joseph Brami, New York, N. Y.

The patent discloses a compression loudspeaker (Fig. 1) in which the diaphragm is driven by a dual-winding voice coil. The winding connected to terminals A-A is fed with the sound signal (curve A, Fig. 2) and the other winding (terminals B-B) is fed with a rectified current (curve B, Fig. 2) derived from the sound signal. The rectified current is fed in such a direction that the diaphragm, while vibrating, moves backward from the chamber wall as a function of its am-

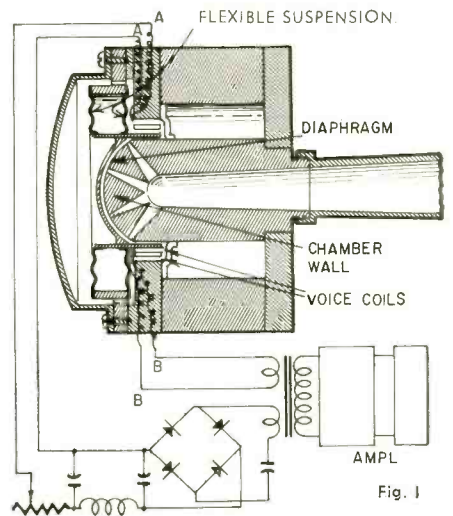

Fig. 1

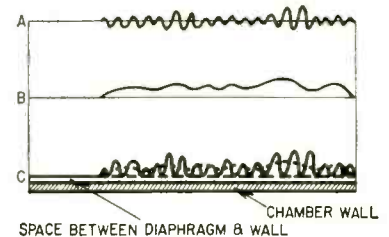

Fig. 2

plitudes. As a result (curve C, Fig. 2) the diaphragm vibrated "unilaterally" from its no-signal resting position. This prevents its bumping against the chamber wall and permits its compressions to be complete for all amplitudes. A flexible suspension allows the diaphragm unlimited excursions, so that the entire sound-frequency range is reproduced with high fidelity and a considerable amount of sound power is delivered. The patent seeks to solve the problem of the high-fidelity speaker with a single diaphragm, and also that of the long-range sound projector.

**URBAN MOBILE RADIO**

Patent No. 2,941,201

Wallace C. Babcock, Chatham, N. J. (Assigned to Bell Telephone Labs, Inc.)

Police and other mobile radio systems are seriously handicapped in large cities because tall buildings throw deep radio shadows. Here is a method for overcoming this problem. It is based on the fact that streets generally run at right angles to each other.

The diagram shows several blocks of a city, streets (S) running at right angles to avenues (A). The plan is to locate 2 transmitters several miles from the city, with antennas on high towers. The stations transmit the same signal.

**ELECTRONICS**

**Engineering-Technicians**

Bachelor of Science Degree, 30 Months

Save Two Years' Time

- Radio-Television Plus Color Technician (12 Months)
- Electronics Technician (12 Months)
- Industrial Electronics Technician (12 Months)
- Electronics Engineering (B.S. Degree)
- Electrical Engineering (B.S. Degree)
- Mechanical Engineering (B.S. Degree)
- Civil Engineering (B.S. Degree)
- Architecture (B.S. Degree)

Heald College ranks **FIRST** West of the Mississippi in "Who's Who in America"

Approved for Veterans  
**DAY AND EVENING CLASSES**  
Write for Catalog and Registration Application.  
New Term Starting Soon.

Your Name \_\_\_\_\_  
Address \_\_\_\_\_  
City \_\_\_\_\_  
State \_\_\_\_\_



U.S. Air Force Photo

Missile headed for outer space. Courtesy of Space Technology Laboratories, Inc.

**HEALD'S ENGINEERING COLLEGE**

Established 1863

Van Ness at Post, RE  
San Francisco, Calif.

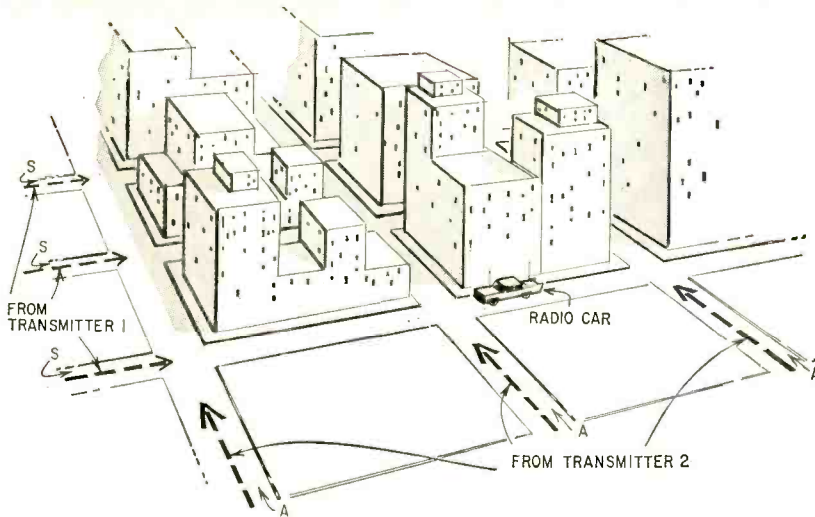

One sends in a direction along the avenues, the other along the streets. The radio car or mobile station uses a directional antenna composed of two quarter-wave whips mounted fore and aft on the vehicle. The antenna has a

sharp "figure 8" response pattern with its major axis along the car's longitudinal axis. Regardless of whether a mobile unit is riding along a street or an avenue, it always picks up a strong signal.

### DIODE BRIDGE GATE

Patent No. 2,965,771

Leonard Finkel, Haddonfield, N. J. (Assigned to American Bosch Arma Corp., Hempstead, N. Y.)

This gate opens and closes periodically. When it conducts, E1 is connected directly to the output terminals; otherwise it is isolated. The circuit may be used to sample a signal. The gating pulses, E2, are stepped up by a transformer and fed across the four-diode bridge (with polarity shown).

The diagram shows four diodes. Note, also, the back-to-back Zener. If the gating pulse is large enough, it breaks down the nonconducting section of the Zener, making P more positive than N. This biases each arm of the bridge to

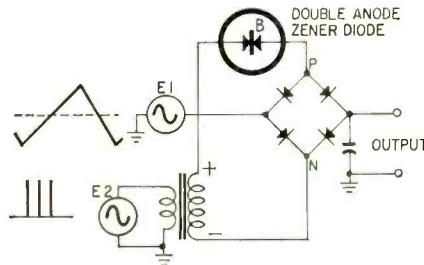

conduction and a low impedance exists between E1 and the output terminals. When there are no gating pulses, E1 cannot get through. It is blocked by the diodes in the bridge.

### TRIPLE CONDITION INDICATOR

Patent No. 2,962,703

Ray E. Summerer, Grand Blanc, Mich. (Assigned to General Motors Corp., Detroit)

These colored pilot lamps indicate three operating conditions. The bridge contains three resistive arms, the fourth being one of the lamps. The bridge balances when either the red or the white lamp is switched into the lower left arm.

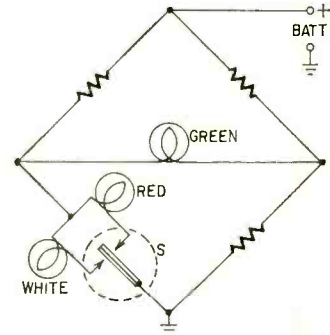

A three-position bimetal switch (S) is exposed to heat, for example from an engine coolant. When the temperature is normal, the switch is in neutral (as shown). If there is too much heat, it closes the right contact and, if too little, the left contact is closed.

With normal heat (see diagram), the switch is open and the bridge unbalanced. The green light goes on. At high temperature the red light is on, and at low temperature the white one shines. In both of these cases the bridge balances so the green light is off. END

# "ONE DOLLAR BUYS"

As Much as \$15 worth—Everything Brand New and sold to you with a money back guarantee  
Pick ANY 1 DOLLAR BUY FREE with every 10 you buy.  
FREE GIFT—with every Order of \$5.00 or over.

HANDY WAY TO ORDER—Simply tear out advertisement and pencil mark items wanted. (Dot in square is sufficient). Enclose with money order or check. You will receive a new copy of this ad for re-orders. ON SMALL ORDERS—Include stamps for postage, excess will be refunded. Larger orders shipped express collect.

- |  |   |  |
|--|---|--|
| <ul style="list-style-type: none"> <li><input type="checkbox"/> 100 - ASST. CERAMIC CONDENSERS.....\$1</li> <li><input type="checkbox"/> 100 - ASST. 1/2 WATT RESISTORS some 5%.....\$1</li> <li><input type="checkbox"/> 70 - ASSORTED 1 WATT RESISTORS.....\$1</li> <li><input type="checkbox"/> 35 - ASSORTED 2 WATT RESISTORS.....\$1</li> <li><input type="checkbox"/> 50 - ASST. TUBULAR CONDENSERS.....\$1</li> <li><input type="checkbox"/> 50 - ASSORTED FUSES popular sizes.....\$1</li> <li><input type="checkbox"/> 50 - 1000Ω 1/2 WATT RESISTORS 10%.....\$1</li> <li><input type="checkbox"/> 75 - 470KΩ 1/2 WATT RESISTORS 10%.....\$1</li> <li><input type="checkbox"/> 10 - WIREWOUND RESISTORS 50 ohm 10w.....\$1</li> <li><input type="checkbox"/> 10 - WIREWOUND RESISTORS 650 ohm 10w.....\$1</li> <li><input type="checkbox"/> 10 - WIREWOUND RESISTORS 1K ohm 10w.....\$1</li> <li><input type="checkbox"/> 5 - DIODE CRYSTALS 1N34A.....\$1</li> <li><input type="checkbox"/> 5 - DIODE CRYSTALS 1N60.....\$1</li> <li><input type="checkbox"/> 5 - DIODE CRYSTALS 1N64.....\$1</li> <li><input type="checkbox"/> 5 - DIODE CRYSTALS 1N69.....\$1</li> <li><input type="checkbox"/> 10 - ASST. WIREW'ND RES. 5, 10, 20 watt.....\$1</li> <li><input type="checkbox"/> 10 - HV TUBULAR CONDENSERS 006-1000v.....\$1</li> <li><input type="checkbox"/> 35 - ASST. DISC CERAMICS best numbers.....\$1</li> <li><input type="checkbox"/> 50 - ASST. MICA CONDENSERS some in 5%.....\$1</li> <li><input type="checkbox"/> 6 - ASST. SLIDE SWITCHES spst, dpdt, etc.....\$1</li> <li><input type="checkbox"/> 3 - ASST. TOGGLE SWITCHES spst, dpdt, etc.....\$1</li> <li><input type="checkbox"/> 15 - ASST. ROTARY SWITCHES \$15 best size.....\$1</li> <li><input type="checkbox"/> 100' - FINEST NYLON DIAL CORD best size.....\$1</li> <li><input type="checkbox"/> 200 - SELF TAPPING SCREWS #8 x 1/2".....\$1</li> <li><input type="checkbox"/> 35 - ASST. RADIO KNOBS screw and push-on.....\$1</li> <li><input type="checkbox"/> 100 - ASSORTED KNOB SET-SCREWS.....\$1</li> <li><input type="checkbox"/> 25 - ASSORTED CLOCK RADIO KNOBS.....\$1</li> <li><input type="checkbox"/> 35 - ASST. SOCKETS octal, noval and miniature.....\$1</li> <li><input type="checkbox"/> 25 - ASST. PRINTED CIRCUIT SOCKETS.....\$1</li> <li><input type="checkbox"/> 10 - ASST. VOLUME CONTROLS less switch.....\$1</li> <li><input type="checkbox"/> 5 - ASST. VOLUME CONTROLS with switch.....\$1</li> <li><input type="checkbox"/> 10 - 50 K VOLUME CONTROLS less switch.....\$1</li> <li><input type="checkbox"/> 20 - ASST. PILOT LIGHTS popular types.....\$1</li> <li><input type="checkbox"/> 10 - PILOT LIGHT SKTS. incandescent type, wired.....\$1</li> <li><input type="checkbox"/> 50 - ASST. TERMINAL STRIPS 1, 2, 3, 4 lead.....\$1</li> <li><input type="checkbox"/> 10 - ASST. RADIO ELECTRO. CONDENSERS.....\$1</li> <li><input type="checkbox"/> 5 - ASST. TV ELECTROLYTIC CONDENSERS.....\$1</li> <li><input type="checkbox"/> 20 - TUBULAR CONDENSERS .01-600v.....\$1</li> <li><input type="checkbox"/> 15 - TUBULAR CONDENSERS .47-400v.....\$1</li> <li><input type="checkbox"/> 15 - TUBULAR CONDENSERS 1-600v.....\$1</li> <li><input type="checkbox"/> 15 - TUBULAR CONDENSERS .047-600v.....\$1</li> <li><input type="checkbox"/> 2 - ELECTROLYTIC COND. 40/40-450v.....\$1</li> <li><input type="checkbox"/> 3 - ELECTROLYTIC COND. 50/30-150v.....\$1</li> <li><input type="checkbox"/> 35 - DISC. CERAMIC CONDENSERS 5000mmf.....\$1</li> <li><input type="checkbox"/> 25 - ASST. RADIO DIAL POINTERS.....\$1</li> <li><input type="checkbox"/> 600 - ASST. H'DWARE screws, nuts, rivets, etc.....\$1</li> <li><input type="checkbox"/> 8 - ASST. LUCITE CASES handy for parts.....\$1</li> </ul> | <ul style="list-style-type: none"> <li><input type="checkbox"/> 2 - MICROPHONES 200 Ohm, hi-gain.....\$1</li> <li><input type="checkbox"/> 1 - 5" PM SPEAKER alnico #5 magnet.....\$1</li> <li><input type="checkbox"/> 1 - 4" PM SPEAKER alnico #5 magnet.....\$1</li> <li><input type="checkbox"/> 1 - 3" PM SPEAKER alnico #5 magnet.....\$1</li> <li><input type="checkbox"/> 1 - 3 1/2" TWEETER SPEAKER for HI-FI.....\$1</li> <li><input type="checkbox"/> 5 - SETS SPEAKER PLUGS wired.....\$1</li> <li><input type="checkbox"/> 3 - AUDIO OUTPUT TRANS. 50L6 type.....\$1</li> <li><input type="checkbox"/> 2 - AUDIO OUTPUT TRANS. 50L6 push-pull.....\$1</li> <li><input type="checkbox"/> 3 - AUDIO OUTPUT TRANS. 6K6 or 6V6 type.....\$1</li> <li><input type="checkbox"/> 3 - I.F. COIL TRANSFORMERS 456 kc.....\$1</li> <li><input type="checkbox"/> 3 - I.F. COIL TRANSFORMERS 10.7 mc. FM.....\$1</li> <li><input type="checkbox"/> 3 - I.F. COIL TRANSFORMERS 262 kc (auto).....\$1</li> <li><input type="checkbox"/> 40 - ASST. PRECISION RESISTORS best sizes.....\$1</li> <li><input type="checkbox"/> 5 - SELENIUM RECTIFIERS 65ma 1Hst \$1.50 ea.....\$1</li> <li><input type="checkbox"/> 4 - SELENIUM RECTIFIERS 75ma.....\$1</li> <li><input type="checkbox"/> 3 - SELENIUM RECTIFIERS 100 ma.....\$1</li> <li><input type="checkbox"/> 2 - SELENIUM RECTIFIERS 300ma.....\$1</li> <li><input type="checkbox"/> 2 - SELENIUM RECTIFIERS 1-350ma 1-75ma.....\$1</li> <li><input type="checkbox"/> 1 - SELENIUM RECTIFIER 500 ma.....\$1</li> <li><input type="checkbox"/> 3 - ASST. SIZES RADIO CHASSIS PANS.....\$1</li> <li><input type="checkbox"/> 3 - VARIABLE CONDENSERS super 420/162mfd.....\$1</li> <li><input type="checkbox"/> 50 - STRIPS ASST. SPAGHETTI. best sizes.....\$1</li> <li><input type="checkbox"/> 100 - ASST. RUBBER GROMMETS best sizes.....\$1</li> <li><input type="checkbox"/> 4 - OVAL LOOP ANTENNAS ass't hi-gain types.....\$1</li> <li><input type="checkbox"/> 3 - LOOPSTICK ANT. new ferrite adjustable.....\$1</li> <li><input type="checkbox"/> 3 - 1/2 MEG VOLUME CONTROLS with switch.....\$1</li> <li><input type="checkbox"/> 5 - ASST. 4 WATT WIREWOUND CONTROLS.....\$1</li> <li><input type="checkbox"/> 5 - 1/2 MEG VOLUME CONTROLS less switch.....\$1</li> <li><input type="checkbox"/> 5 - 1 or 2 MEG VOLUME CONTROLS 1/switch.....\$1</li> <li><input type="checkbox"/> 10 - SURE GRIP ALLIGATOR CLIPS.....\$1</li> <li><input type="checkbox"/> 1 - GOLD GRILL CLOTH 14"x14" or 12"x18".....\$1</li> <li><input type="checkbox"/> 10 - SETS PHONO PLUGS and PIN JACKS.....\$1</li> <li><input type="checkbox"/> 2 - \$2.50 SAPPHIRE NEEDLES 4000 playings.....\$1</li> <li><input type="checkbox"/> 3 - ELECTROLYTIC CONDENSERS 80-400v.....\$1</li> <li><input type="checkbox"/> 35 - MICA COND. 20-50 mmf &amp; 15-68 mmf.....\$1</li> <li><input type="checkbox"/> 35 - MICA COND. 20-100 mmf &amp; 15-270 mmf.....\$1</li> <li><input type="checkbox"/> 35 - MICA COND. 20-470 mmf &amp; 15-680 mmf.....\$1</li> <li><input type="checkbox"/> 35 - MICA COND. 20-820 mmf &amp; 15-1000 mmf.....\$1</li> <li><input type="checkbox"/> 35 - MICA COND. 20-2200 mmf &amp; 15-2400 mmf.....\$1</li> <li><input type="checkbox"/> 35 - MICA COND. 20-6800 mmf &amp; 15-10000 mmf.....\$1</li> <li><input type="checkbox"/> 35 - CERAMIC COND. 20-5 mmf &amp; 15-10 mmf.....\$1</li> <li><input type="checkbox"/> 35 - CERAMIC COND. 20-25 mmf &amp; 15-47 mmf.....\$1</li> <li><input type="checkbox"/> 35 - CERAMIC COND. 20-56 mmf &amp; 15-82 mmf.....\$1</li> <li><input type="checkbox"/> 35 - CERAMIC COND. 20-100 mmf &amp; 15-150 mmf.....\$1</li> <li><input type="checkbox"/> 35 - CERAMIC COND. 20-270 mmf &amp; 15-470 mmf.....\$1</li> <li><input type="checkbox"/> 35 - CERAMIC COND. 20-1000 mmf &amp; 15-1500 mmf.....\$1</li> <li><input type="checkbox"/> 35 - CERAMIC COND. 20-2000 mmf &amp; 15-5000 mmf.....\$1</li> </ul> | <ul style="list-style-type: none"> <li><input type="checkbox"/> \$15 - "JACKPOT" TELEVISION PARTS.....\$1</li> <li><input type="checkbox"/> 10 - TOPNAME 1U4 TUBES also serves as 1U4.....\$1</li> <li><input type="checkbox"/> 20 - TUBULAR COND. .17-100v (tests 600v).....\$1</li> <li><input type="checkbox"/> 4 - KENRAD 65H7 TUBES.....\$1</li> <li><input type="checkbox"/> 3 - 6AL5 unbranded, perfect.....\$1</li> <li><input type="checkbox"/> 2 - TOP NAME 125K7 TUBES.....\$1</li> <li><input type="checkbox"/> 2 - GENERAL ELECTRIC TUBES 35W4.....\$1</li> <li><input type="checkbox"/> TOP NAME TUBES OZ4, 1B3, 1X2B, 5U4, 6AC7, 6AX4, 6CB6, 6J6, 6K6, 6B8, 6V6, 6SN7, 6X8, 12AU7, 12AX7, 50L6.....Each \$1</li> <li><input type="checkbox"/> 105, 1LE3, 6H6, 6F8, VR105, 65H7.....Each 25c</li> <li><input type="checkbox"/> 12 - RADIO OSCILLATOR COILS 456 kc.....\$1</li> <li><input type="checkbox"/> 1 - LB. SPOOL ROSIN CORE SOLDER.....\$1</li> <li><input type="checkbox"/> 4 - 50' SPOOLS HOOK-UP WIRE 4 colors.....\$1</li> <li><input type="checkbox"/> 10 - 6' ELECTRIC LINE CORDS with plugs.....\$1</li> <li><input type="checkbox"/> 5 - TV CHEATER CORDS with both plugs.....\$1</li> <li><input type="checkbox"/> 5 - TV CRT. SOCKETS with 18" leads.....\$1</li> <li><input type="checkbox"/> 50' - ZIP CORD #18 2-cond. (brown or ivory).....\$1</li> <li><input type="checkbox"/> 100' - TWIN LEAD-IN WIRE 300Ω heavy duty.....\$1</li> <li><input type="checkbox"/> 50' - FLAT 4-CONDUCT. WIRE many purposes.....\$1</li> <li><input type="checkbox"/> 25' - INSULATED SHIELDED WIRE.....\$1</li> <li><input type="checkbox"/> 32' - TEST PROD WIRE deluxe (red or black).....\$1</li> <li><input type="checkbox"/> 1 - S7 INDOOR TV ANTENNA hi-gain 3 section.....\$1</li> <li><input type="checkbox"/> 20 - ASST. TV KNOBS, ESCUTCHEONS, Etc.....\$1</li> <li><input type="checkbox"/> 1 - RCA 70° FLYBACK TRANS. #75240.....\$1</li> <li><input type="checkbox"/> 3 - TODD 60° DEFLECTION YOKES.....\$1</li> <li><input type="checkbox"/> 1 - FLYBACK TRANS. 90° w/ schematic.....\$1</li> <li><input type="checkbox"/> 1 - TV VERT. OUTPUT TRANS. 10 to 1 ratio.....\$1</li> <li><input type="checkbox"/> 15 - ASST. TV COILS sync. peaking, width, etc.....\$1</li> <li><input type="checkbox"/> 15 - ASST. STANDARD TUNER VHF STRIPS.....\$1</li> <li><input type="checkbox"/> 2 - SILICON RECTIFIERS 500ma.....\$1</li> <li><input type="checkbox"/> 1 - SILICON RECTIFIER 750ma.....\$1</li> <li><input type="checkbox"/> 25 - ASST. PEAKING COILS popular types.....\$1</li> <li><input type="checkbox"/> 10 - TV CARTWHEEL CONDENSERS 10kv.....\$1</li> <li><input type="checkbox"/> 5 - TV CARTWHEEL CONDENSERS 15kv.....\$1</li> <li><input type="checkbox"/> 2 - TV CARTWHEEL CONDENSERS 30 kv.....\$1</li> <li><input type="checkbox"/> 1 - TV RATIO DETECTOR COIL 4.5mc.....\$1</li> <li><input type="checkbox"/> 1 - TV RATIO DETECTOR COIL 10.7mc.....\$1</li> <li><input type="checkbox"/> 1 - TV SOUND I.F. COIL 4.5mc.....\$1</li> <li><input type="checkbox"/> 3 - HV RECTIFIER SOCKETS 1B3 mounted.....\$1</li> <li><input type="checkbox"/> 3 - HV RECTIFIER SOCKETS 1X2 mounted.....\$1</li> <li><input type="checkbox"/> 1 - TV SYNCHROGUIDE COIL #205R1.....\$1</li> <li><input type="checkbox"/> 3 - TV ALIGNMENT TOOLS assortment #1.....\$1</li> <li><input type="checkbox"/> 3 - TV ALIGNMENT TOOLS assortment #2.....\$1</li> <li><input type="checkbox"/> 3 - TV ALIGNMENT TOOLS assortment #3.....\$1</li> <li><input type="checkbox"/> 3 - TV ALIGNMENT TOOLS assortment #4.....\$1</li> <li><input type="checkbox"/> 3 - TV ALIGNMENT TOOLS assortment #5.....\$1</li> </ul> |
|--|---|--|

EACH ALIGNMENT TOOL is different and valued at over \$1

**BROOKS RADIO & TV CORP., 84 Vesey St., Dept. A, New York 7, N.Y.** TELEPHONE CORland 7-2359

# MUSIC BIG AS LIFE

with Utah's ADD-ON  
Reverberation Unit

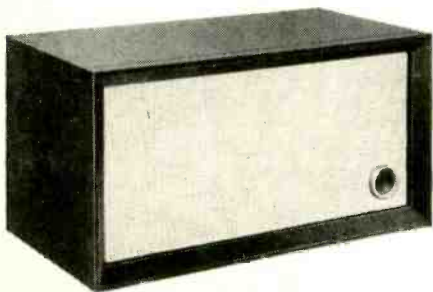

➡ Lets you control acoustic dimensions at the touch of a dial ➡ Self-contained speaker and amplifier unit hooks into any radio, phono or component sound system (mono or stereo) ➡ Blends sound acoustically in the room, adds rich new dimension to music. List price: **\$89.95**

MAIL COUPON FOR FREE BROCHURE

**utah**

RADIO & ELECTRONIC CORP.  
Huntington, Indiana

Please mail me free literature including specifications on your add-on reverberation unit and name of nearest Utah dealer.

NAME \_\_\_\_\_

ADDRESS \_\_\_\_\_

CITY \_\_\_\_\_ STATE \_\_\_\_\_

(RE)



TRY  
THIS  
ONE

## BENCH CLEANING KINK

Electronic technicians and experimenters usually get their workbenches pretty well messed up during the course of their work. For cleanup purposes a swipe across the bench with a rag

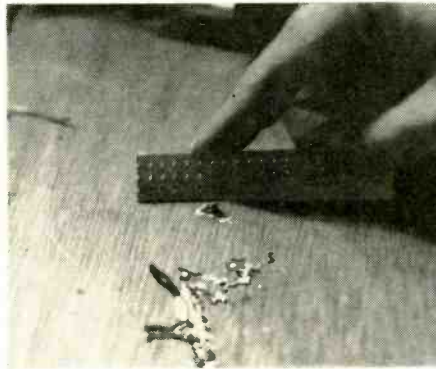

doesn't quite do the job. Small pieces of wire and insulation get caught in the rag. And the excess solder flicked from the soldering iron usually sticks to the bench top. A piece of straight-edged bakelite or Masonite makes a nice cleanup tool. Just scrape it across the bench top. It will gather wire and insulation scraps. And it will quickly loosen and gather solder stuck to the bench top. It works well on floors too. This beats loosening stuck pieces of solder one at a time with a screwdriver or with your fingernails.—Forrest H. Frantz, Sr.

## QUICK CAPACITOR CONNECTIONS

When a can type electrolytic capacitor is used in experimental or bread-board layouts, quicker connections can be made if Fahnestock clips are soldered to the electrolytic's lugs as shown. Since the capacitor's metal case is invariably the negative terminal, solder a clip to it too. With this handy ar-

**FREE** **ALLIED**  
SPECIAL MONEY-SAVING  
ELECTRONIC SALE BOOK



**SAVE** SEE  
HUNDREDS OF  
BARGAINS!

Packed with values  
and products  
available only  
from ALLIED

SAVE MOST on Allied Summer Specials! Terrific closeouts on quality Stereo hi-fi systems and components, tape recorders, phonos, records and tape. Top buys in Allied's own KNIGHT® products and exciting build-your-own KNIGHT-KITS®. Hundreds of specials in radios, cameras, TV accessories, Citizens Band radio, amateur gear, P. A. systems, test instruments, tools and electronic parts. Dozens of new electronic products. Save as never before! Write today for this big Sale Book.

only \$2 down  
on orders up  
to \$50.

**ALLIED RADIO**

ALLIED RADIO, Dept. 53-E1  
100 N. Western Ave., Chicago 80, Ill.

Send Free Allied Sale Book No. 205

Name \_\_\_\_\_  
PLEASE PRINT

Address \_\_\_\_\_

City \_\_\_\_\_ Zone \_\_\_\_\_ State \_\_\_\_\_

**FREE**  
Sale Book

**SPECIAL M7D** STEREO CARTRIDGE \$11.95  
For Super Stereo Quality  
Write for our FREE bargain flyer! A real money saver on Hi Fi equipment. Let us quote you on standard items—Most Prices We Can Beat!  
**CUTICK ELECTRONICS**  
Tel. Wo 2-5866 N. Y. 7, N. Y.  
171 Washington St.

## TV PICTURE TUBES AT LOWEST PRICES

ALL ALUMINIZED GLASS TYPES					
Tube Type	Price With Old	Tube Type	Price With Old	Tube Type	Price With Old
10BP4	7.95	17BJP4	11.50	21CEP4	21.00
12LP4	8.95	17CDP4	11.50	21CX4	15.75
14AJ4	14.00	17CK/CA/3Z/		21DEP4	21.00
14ATP4	14.00	BRP4	17.00	21DFP4	21.00
14B/E/CP4	10.00	17DLP4	17.00	21DLP4	21.00
14HP4	11.00	17WRP4	12.50	21DS4	21.00
14QP4	11.00	17VP4	12.50	21EP4	14.25
14RP4	11.00	20C/DP4	13.50	21FP4	14.50
14W/ZP4	11.00	20H/MP4	14.50	21XP4	16.50
14XP4	11.60	21AC/BS/		21YP4	16.00
16DP4	12.00	AMP4	15.75	21ZP4	15.50
16K/RP4	9.95	21AL/ATP4		24C/VP4	23.50
16LP4	12.50	21AU/AVP4	16.75	24AEP4	24.50
16TP4	9.95	21AWP4	15.75	24HP4	26.50
16WP4	12.00	21BTP4	16.75	24EP4	24.50
17AT/AVP4	12.50	21CBP4	16.75	27EP4	39.95
17BP4	9.95			27RP4	39.95
				27SP4	40.95

**METAL TYPES**  
12UP4 12.00 16GP4 14.50 19AP4 16.00  
16AP4 13.50 17CP4 17.00 21AP4 19.75  
16EP4 14.00 17GP4 17.60 21MP4 20.75  
17TP4 17.60

**TEST TUBES**  
8XP4 16.07 8YP4 16.07

1 year warranty

Prices include the return of an acceptable similar tube under vacuum. These tubes are manufactured from reprocessed used glass bulbs. All parts and materials including the electron gun are brand new.

ALL PRICES FOB CHICAGO, ILLINOIS. Deposit required, when old tube is not returned, refundable at time of return. 25% deposit required on COD shipments. Old tubes must be returned prepaid. Tubes shipped Rail Express. Shipped only to Continental U.S. and Canada.

WRITE FOR COMPLETE LIST

**PICTURE TUBE OUTLET**  
2922 MILWAUKEE AVE., CHICAGO 18, ILLINOIS  
Dickens 2-2048



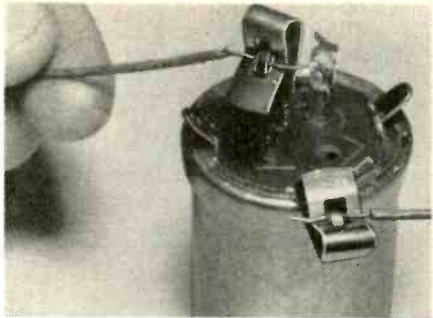

angement, the capacitor can be wired in and out of the circuit in a jiffy. By connecting test leads to the capacitor's clips it can be easily used to find bad filter capacitors in radios, TV's and other gear by the substitution method.—*Joe Crane*

### FUSED CHEATER CORD

The cheater cords used by our outside men all have a fuse holder and 5-amp auto fuse in series with one leg. This prevents blowing the customer's fuse and the subsequent time-wasting hunt to replace it.—*Stan Clark*

### TV PIX ON SCOPE

Here's a method I use for substituting an oscilloscope for the picture tube in a TV set. I have been getting excellent results with this method and find that many times it has taken the guesswork out of servicing.

This is how I hook up my Heath O-10 scope to a typical TV set:

- ▶ Vertical input ( $\times 100$ ) to plate of vertical output tube.
- ▶ Horizontal input to output of horizontal oscillator (grid lead to horizontal output).

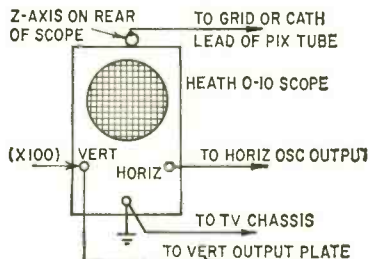

▶ Z-axis input of scope to grid or cathode of picture tube depending on whether circuit uses grid- or cathode-modulated tube.

▶ Ground scope to TV, set horizontal frequency control to external input and there you are.

One word of warning: the scope's intensity control must be turned down before turning off the TV or the high intensity of the undeflected beam might burn the screen.—*Charles M. Breidenstein*

### EXTRA-THIN NUTS

When an extra-thin nut is required in some cramped part of a chassis, cut a small square of sheet metal, punch a hole through it and tap the hole with threads to fit the matching screw. Punching instead of drilling bends the metal outward around the hole, adding metal for a longer thread.—*Harry J. Miller* END

# FREE

## GIANT 1961 204 PAGE CATALOG

# B-A 1961

ANNUAL CATALOG 6TH

SINCE 1927

**Guarantee**

We guarantee every item in our catalogs to be honestly described and illustrated... to be the best and most complete... to perform to the degree warranted by the nature... or your money back!

SAVE UP TO 50% ON B-A SELECTED KITS

TOP VALUES IN POWER AND HAND TOOLS

HI-FI AND STEREO SYSTEMS & COMPONENTS

30 PAGES OF BARGAINS NOT IN ANY OTHER CATALOG

100'S OF NEW ITEMS LISTED HERE FOR 1ST TIME

*A Complete Buying Guide for Everything in*

# RADIO TV ELECTRONICS

for DEALERS, SERVICE MEN, SCHOOLS, BROADCASTERS, INDUSTRIALS, THEATRES, MANUFACTURERS, CHURCHES, HOTELS, PUBLIC UTILITIES, LABORATORIES, ENGINEERS, EXPERIMENTERS, AMATEURS

INDEX PAGE 201 202 PHONE BALTIMORE 7-1115

RUSH COUPON TODAY!

1017 W. MCGEE ST., KANSAS CITY 6, MO.

BURSTEIN-APPLEBEE CO. Dept. RE  
1012-14 McGee St., Kansas City 6, Mo.

Send Free 1961 B-A Catalog No. 611

NAME \_\_\_\_\_

ADDRESS \_\_\_\_\_

CITY \_\_\_\_\_ STATE \_\_\_\_\_



## QUICK and LASTING

When You Use  
**HUSH®**

Chemically-Electronically, engineered for Tuners and Switching Mechanisms.

When New HUSH is applied it will wash-away that dirt, leaving clean and positive contacts protected by a lasting lubricant. New HUSH is made from the finest solvents and it contains Electro-Silicone oils.  
6 oz. Spray can. Also available—2 oz., 8 oz., 32 oz. containers

**EVER-QUIET®**  
Since 1949

VOLUME CONTROL AND CONTACT RESTORER  
EVER-QUIET is a free-flowing liquid that leaves no powder residue. Scientifically designed to seep around the shaft and penetrate the control or potentiometer, cleaning the contacts and leaving a safe protecting film. Harmless to metals, wire or carbon.

2 oz. Bottle & dispenser. Also available—6 oz. Spray can  
FREE 6" Plastic Extender With Every Can



CHEMICAL ELECTRONIC ENGINEERING, INC., Matawan, New Jersey

## BECOME A RADIO TECHNICIAN FOR ONLY \$26.95

### BUILD 20 RADIO CIRCUITS AT HOME

with the New **PROGRESSIVE RADIO "EDU-KIT"®** only **\$26.95**

ALL Guaranteed to Work!

#### A Complete Home Radio Course

- BUILD**
- 12 Receivers
  - 3 Transmitters
  - Signal Tracer
  - Signal Injector
  - Code Oscillator
  - Sq. Wave Generator
  - Amplifier

- No Knowledge of Radio Necessary
- No Additional Parts or Tools Needed
- Excellent Background for TV



Reg. U.S. Pat. Off.

**FREE** Set of Tools, Pliers-Cutters, Alignment Tool, Wrench Set.

### WHAT THE "EDU-KIT" OFFERS YOU

The "Edu-Kit" offers you an outstanding PRACTICAL HOME RADIO COURSE at a rock-bottom price. You will learn radio theory, construction and servicing. You will learn how to build radios, using regular schematics; how to solder and wire in a professional manner; how to service and trouble-shoot radios. You will learn how to work with punched metal chassis as well as the new Printed Circuit chassis. You will learn the principles of RF and AF amplifiers and oscillators, detectors, rectifiers, test equipment. You will learn and practice code, using the Progressive Code Oscillator. You will build 20 Receivers, Transmitter, Code Oscillator, Signal Tracer, Square Wave Generator, Amplifier and Signal Injector circuits, and learn how to operate them. You will receive an excellent background for TV. In brief, you will receive a basic education in Electronics and Radio, worth many times the small price you pay, only \$26.95 complete.

#### PROGRESSIVE TEACHING METHOD

The Progressive Radio "Edu-Kit" is the foremost educational radio kit in the world, and is universally accepted as the standard in the field of electronics training. The "Edu-Kit" uses the modern educational principle of "Learn by Doing." You begin by building a simple radio. Gradually, in a progressive manner, and at your own rate, you construct more advanced multi-tube radio circuits, learn more advanced theory and techniques, and do work like a professional radio technician. These circuits operate on your regular AC or DC house current.

#### THE KIT FOR EVERYONE

You do not need the slightest background in radio or science. The "Edu-Kit" is used by young and old, schools and clubs, by Armed Forces Personnel and Veterans Administration for training and rehabilitation. One of the most important aspects of the "Edu-Kit" is the Consultation Service which we provide. We welcome students to send us their problems, whether related to any of the material covered in the "Edu-Kit" course, or encountered in other experiences in the field of electronics.

#### THE "EDU-KIT" IS COMPLETE

You will receive all parts and instructions necessary to build 20 different radio and electronic circuits, each guaranteed to operate. Our kits contain tubes, tube sockets, variable electrolytic, mica, ceramic and paper dielectric condensers, resistors, tie strips, coils, hardware, tuning, punched metal chassis, Instruction Manuals, hook-up wire, solder, selenium rectifiers, volume controls, switches, etc. In addition, you receive Printed Circuit materials, including Printed Circuit Chassis, special tube sockets, hardware and instructions. You also receive a useful set of tools, pliers, cutters, an automatic electric soldering iron, wrench set, and self-powered, dynamic Radio and Electronics Tester. The "Edu-Kit" also includes Code instructions and the Progressive Code Oscillator. You will also receive lessons for servicing with the Progressive Signal Tracer and the Progressive Signal Injector, a High Fidelity Guide, FCC Amateur License Training Book, and a Quiz Book.

#### TROUBLE-SHOOTING LESSONS

You will learn to trouble-shoot and service radios, using the professional Signal Tracer, the unique Signal Injector and the dynamic Radio and Electronics Tester. Our Consultation Service will help you with any technical problems.

#### FREE EXTRAS

- Set of Tools • Radio Book • Radio and Electronics Tester • Electric Soldering Iron • Pliers-Cutters • Alignment Tool • Instruction Book • Hi-Fi Book • TV Book • Quiz Book • Membership in Radio-TV Club • Consultation Service • FCC Amateur License Training • Printed Circuitry • Certificate of Merit • Valuable Discount Card • Wrench Set

UNCONDITIONAL MONEY-BACK GUARANTEE

ORDER FROM AD—RECEIVE FREE BONUS RESISTOR AND CONDENSER KITS WORTH \$7.00

- "Edu-Kit" Postpaid. Enclosed full payment of \$26.95.
- "Edu-Kit" C.O.D. I will pay \$26.95 plus postage.
- Send me FREE additional information describing "Edu-Kit."

Name.....  
Address.....

PROGRESSIVE "EDU-KITS" INC.  
1186 Broadway, Dept. 176G, Hewlett, N. Y.

# BUSINESS and PEOPLE

Adolph Wolf was appointed vice president of Manufacturing for Electro-Voice, Inc., Buchanan, Mich. He comes to the company from Zenith Radio where



he was assistant general production engineer. Jon Kelly and Rod Griggs joined the regular sales staff as trainees. Kelly formerly handled technical correspondence for high-fidelity and commercial sound products and Griggs was a correspondent in the Marine Div. for communication equipment.

Jan Bleeksma was appointed vice president in charge of manufacturing at Amperex Electronic Corp., Hicksville, N. Y. He had been plant manager.



Donald H. Bittner was promoted to Eastern regional distributor sales manager for Shure Brothers, Inc., Evanston, Ill. He has been with the company since 1956.



M. S. Sumberg was promoted to the newly created position of director of sales, sound products and high fidelity, for the Bogen-Presto Div. of the Siegler Corp., Paramus, N. J. He has been with the company since 1949 in a variety of executive marketing positions. Harold Barton (left) joined the company as sales manager for high-fidelity equipment from United Audio Products.



James W. Kearns, administrative assistant to the president, was promoted to field sales specialist. David E. Pear, Arthur Callahan and Harris Anderman continue as managers of Advertising



## SURPLUS RADIO CONVERSION DATA now 4 volumes . . . hundreds of instructions, diagrams and photographs.

**SURPLUS RADIO CONVERSION MANUALS—3 Volumes—\$3.00 ea.** Conversion data in these volumes has become standard for the most commonly available surplus items. Each conversion shown yields a useful piece of equipment . . . is practical, and proved by testing.

**VOLUME I**—BC-221; BC-342; BC-312; BC-348; BC-412; BC-645; BC-946; SCR-274 (BC-453A Series); SCR-274 (BC-457A Series); SCR-522 (BC-625, 624); TBY; PE-103A; BC-1068A/1161A; Electronics Surplus Index; Cross Index of A/N Vac. Tubes; Amateur Freq. Allocations; TV and FM Channels.

**VOLUME II**—BC-454 or ARC-5; AN/APS-13; BC-457 or ARC-5; ARC-5 V.H.F.; GO-9/TBW; BC-357; BC-946B; BC-375; LM Freq. Meter; TA-12B; AN/ART-13; Simplified Coil-Winding Charts; Selenium-Rectifier Power Units; AVT-112A; AM-26/AIC; Surplus Beam Rotating Mechs.; Prim. Power Req. Chart; ARB Rcvr. (Diagram only).

**VOLUME III**—701-A; APN-1; APN-4; ARC-4; ARC-5; ART-13; ATA; BC-191, 312, 342, 348, 375, 442, 456-459, 609, 624, 696, 950, 1066, 1253; COL-43065; CRC-7; DM-34; DY-2; DY-8; FT-241A; LM; MBF; MD-7/ARC-5; R-9/APN-4; R-28/ARC-5; RM-52; RM-53; RT-19/ARC-4; RT-159; SCR-274N, 508, 522, 528, 538, T-15; T-23/ARC-5; URC-4. Diagrams only: APA-10; APT-2; APT-5; ARR-2; ASB-5; BC-659; BC-1335A; CPR-46ACJ.

**THE SURPLUS HANDBOOK (Receivers and Transceivers) \$3.00**

**VOLUME I**—Schematic Diagrams and large photographs only—APN-1; APS-13; ARB; ARC-4; ARC-5 (L.F.); ARC-5 (V.H.F.); ARN-5; ARR-2; ASB-7; BC-222, 312, 314, 342, 344, 348, 603, 611, 624, 652, 654, 659, 669, 683, 728, 745, 764, 779, 794, 923, 1000, 1004, 1066, 1206, 1306, 1335; BC-AR-231; CRC-7; DAK-3; GF-11; Mark II; MN-26; RAK-5; RAL-5; RAX-1; SCR-522; Super Pro; TBY; TCS.



\*Order from your favorite electronic parts distributor

If he cannot supply, send us his name and your remittance, and we will supply; foreign, add 10%.

**EDITORS and ENGINEERS, Ltd.** Summerland 5, California

Dealers: Electronic distributors, order from us. Bookstores, libraries, newsdealers order from Baker & Taylor, Hillside, N.J. Export (exc. Canada), order from H.M. Snyder Co., 440 Park Ave. So., N.Y. 16.



### OUT OF SPACE?

You bet we'd be . . . if we were to tell you all about AUDION's 'Out of this World Hi Fi Values.'

Write for free Catalog  
**audion**  
25-E Oxford Road  
Massapequa, New York

Please mention  
**RADIO-ELECTRONICS**  
when answering advertisements

and Sales Promotion, Public Address and Intercom, and School and Industrial Systems respectively.

John Kushan was promoted to director of materials of Hickok Electrical Instrument Co., Cleveland, Ohio, from production control manager.



Wesley E. Wood joined Astron Sales Corp., Newark, N. J., as distributor sales manager. He comes from Allen B. Dumont Labs., Div. of Fairchild Camera and Instrument Corp., where he was distributor sales manager of the Electronic Tube Div.



Milton S. Kiver, editor and author in the field of electronics, established a new firm, Milton S. Kiver Publications, Chicago, which will publish a new magazine in the field, and also act as a consultant in the development of new products and techniques.



James W. Blanchard was promoted to assistant credit manager of CBS Electronics, Danvers, Mass. He had been a credit analyst for the company.



Harman-Kardon, Inc., Plainview, N. Y., was merged into Jerrold Electronics Corp., Philadelphia. The merged companies plan an accelerated expansion program. Milton J. Shapp, presi-



dent of Jerrold, (left) and Sidney Harman, president of Harman-Kardon are shown signing the closing papers.

Martin A. Lappin was named national manager for the newly formed TV-Communications Dept., of Westinghouse Electric Corp., Metuchen, N. J. He was formerly vice president of American Communications Corp.



Myron A. Brauner joined Amphel-Borg Electronics Corp., Broadview, Ill., as district sales manager in the Metropolitan New York territory. He has established temporary headquarters in the company's Great Neck, N. Y., offices. He previously had been with Markite Corp. END

# COMPLETE TRAINING

FOR BETTER RADIO-TV SERVICE JOBS

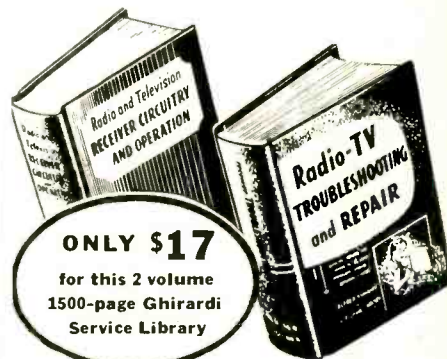

ONLY \$17

for this 2 volume  
1500-page Ghirardi  
Service Library

## FIX ANY TV OR RADIO ever made!

These two giant Ghirardi home training manuals make it easy for you to be an expert on ALL types of TV-AF-FM service... at only a fraction of the price you might expect to pay for such complete training. Almost 1500 pages, over 800 clear illustrations and dozens of procedure charts explain each detail of every service job as clearly as A-B-C. Each book contains up to the minute data. Each is based on approved professional methods. You learn time-saving shortcuts. You learn to go right to the seat of trouble without useless testing; for beginners or as a handy reference library for experienced servicemen who want to look up puzzling jobs or develop new and faster methods.

### A complete guide to TROUBLESHOOTING and REPAIR

① This 820-page Radio & TV TROUBLESHOOTING AND REPAIR MANUAL guides you through each service procedure... from locating troubles to making repairs fast and right. Step-by-step charts cover practically every type of troubleshooting on Television problems to AM and FM realignment to IP and Detector Sections, car radios, record players, communications receivers, etc. 417 illustrations. Price \$10.00 separately. (Outside U.S.A. \$10.50.) See money-saving offer in coupon!

### The complete "know-how" of SET CIRCUITS and OPERATION

② Learn all about circuits and their peculiarities and watch your service "headaches" disappear! This 669-page Radio & TV Receiver CIRCUITRY AND OPERATION manual covers all basic circuits and circuit variations used in modern home equipment; explains their likely trouble spots; teaches you to go right to the seat of trouble without useless testing; helps you develop fast, truly professional service techniques. Price \$9.00 separately. (Outside U.S.A. \$9.50.)

### SAVE \$2.00—Pay As You Learn!

If sold as a course and sent to you in lesson form, you'd regard the material in these two famous manuals as a bargain at \$150 or more, instead you buy them complete in handy book form for only \$17.00 for the two (regular price \$19.00). You save \$2.00. No lessons to wait for! Everything is at your finger tips. You learn fast... and you learn right! OUR MONEY-BACK GUARANTEE PROTECTS YOU!

### STUDY 10 DAYS FREE!

Dept. RE-51, HOLT, RINEHART & WINSTON, INC., 623900  
Technical Div., 383 Madison Ave.,  
New York 17, N.Y.

Send books below for 10-day FREE EXAMINATION. In 10 days I will either remit price indicated (plus postage) or return books postpaid and owe you nothing.

Radio & TV Receiver TROUBLESHOOTING & REPAIR (Price \$10.00 separately) No. 708578

Radio & TV CIRCUITRY & OPERATION (Price \$9.00) No. 708214

Check here for MONEY-SAVING COMBINATION OFFER. Save \$2.00. Send both of above big books at special price of only \$17.00 for the two. (Regular price \$19.00... you save \$2.00.) No. 709096

SAVE! Send cash with order and we pay postage. Same return privilege with money promptly refunded.

Name..... Title.....  
Address.....  
City, Zone, State.....

Outside U.S.A.—\$10.50 for TROUBLESHOOTING & REPAIR; \$9.50 for CIRCUITRY & OPERATION; \$18.00 for both. Cash only, but money refunded if you return books in 10 days.  
Above offer expires Jan. 31, 1962.

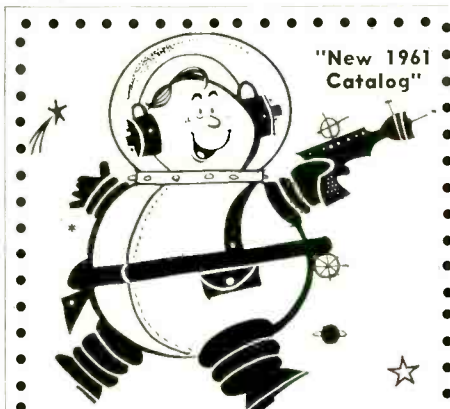

★ A complete catalog of specialized industrial Electronic TUBES and COMPONENTS... featuring Barry Electronics savings to Industry, Servicemen and Experimenters.

• We have thousands of tube types in stock. First Quality at Sensible Prices. Buy with confidence.

• SPECIALS—RCA Herm...id XFMRs: Pri: 115 VAC @ 60 CPS. Sec: 1250 VCT @ 360 Ma. \$4.95. Pri: 115 VAC @ 60 CPS. Sec: 905 VCT @ 360 Ma. \$3.95.

• Merit Choke: 10 Hy. @ 250 Ma. Merit =C-3182. \$2.95.

• RCA PRECISION 500 KC CRYSTAL OSCILLATOR. Accuracy plus or minus 0.0012%. Contains Precision 500 KC crystal. PMS Leads.

• Crystal oven. 5840 sub-miniature tube. Hermetically sealed nickel plated rectangular case. Mounts in standard 7 pin miniature socket. Requires 6.3 VAC or DC. 75 to 100 V.D.C. With schematic. RCA Type A883300-1. Size: 4-1/2" H x 1-7/16" W x 1-1/4" D. Vt: 1 lb. Cr: 2-500 CRV. (Orig. Govt. Cost: \$172.00.) VERY SPECIAL ONLY \$3.75.

• Prove these values to yourself! Complete and mail the coupon below for your copy of the "Greensheet."

• We'll also purchase your equipment and unused tubes. Send details: BARRY ELECTRONICS CORP., 512 Broadway, New York 12, N.Y., Dept. RE-5.

• Please send me a copy of the new 1961 "Greensheet" and add my name to your mailing list.

• Name..... Title.....  
• Company.....  
• Address.....  
• City..... State.....

**PUZZLED?**  
KIT didn't work?  
Probably cold solder joints!

World's Finest  
**ERSIN Multicore**  
FIVE-CORE SOLDER

Sold only by Radio Parts Distributors.  
MULTICORE SALES DIVISION BRITISH INDUSTRIES CORP., Port Washington, N. Y.

**"TAB" Tubes Factory Tested, Boxed—Six Months Guarantee! No Rejects! NEW & Used Gov't & Mfrs. Surplus!**

Orders \$10 or more. Receiving types only ppd, 48 states  
 OA2 .80 6B16 .60 12A76 .50 18S1 1.00  
 OB2 .85 6B17 .90 12A77 .84 17Z6 1.10  
 OC3 .60 6B18 1.25 12A78 .69 45A 16.00  
 OD3 .35 6B19 .88 12A79 .60 2021 2/51  
 OZ4 .50 6B20 1.18 12A77 .79 3D23 3.85  
 1A7 .85 6B21 1.78 12A76 .60 72A 5.00  
 1B3 .78 6C4 .43 12B87 .99 4-125 20.00  
 1R5 .78 6C5 .69 12B86 .59 4-250 35.00  
 1S4 .78 6C6 .80 12B86 .59 4-250 35.00  
 1T4 .78 6C7 1.40 12B86 .59 4PR60 20.50

Send 50¢ for Catalog!  
 1U4 3/81 6H6 3/81 12B87 .99 4X150G 35.00  
 1U5 .70 6H7 .80 12B77 .98 4X250 35.00  
 1X2A 1.00 6J6 .48 12B27 .99 4X500 38.00  
 304 .68 6K6 .59 12C06 1.45 58P1 8.00  
 3Q5 .86 6K7 1.65 12S47 .69 58P 16.00  
 3S4 .68 6L6 1.19 12S67 .89 35T 4.00  
 3V4 .83 6S4 .59 12S77 .89 100T 7.00  
 5K4 .98 6S8 .69 12S17 .75 316 7/81  
 5U4 .78 6SA7 .69 12S77 .84 388A 3/81  
 5V4 .80 6SB7 1.10 12S07 .94 4168 4.00

Wanted Surplus Electronics from schools & U.  
 6B4 .59 6S7 .80 19B06 2.15 450T 42.00  
 6B4B .59 6S7 .70 19T8 1.16 807 1.00  
 6AC7 .70 6S7 .60 25B06 1.39 809 3.00  
 6AG7 .89 6S7 .72 25W4 .70 811 4.40  
 6AH6 .90 6S7 .72 25W4 .77 812 3.00  
 6AK5 .69 6S7 .60 25Z5 .63 813 9.00  
 6AL5 2/81 6S7 2/81 25Z5 2/81 814 14.35  
 6AG5 .83 6S7 .74 1E34 3.49 815 2.75  
 6AS7 3.00 6S7 .79 3L7 2.49 826 1.00  
 6AT6 .49 6T8 .99 35L6 .68 829B 8.00

Wanted Top Piv. 813 and 815 subest!  
 6AU4 1.10 6U8 .98 35W4 .49 832A 7.00  
 6AU5 1.10 6V6GT .70 35V4 .69 872A 3.50  
 6AU6 .80 6W4 .60 80A5 .69 879 2.00  
 6AX4 .70 6W6 .80 80A5 .80 6146 4.00  
 6BA6 .59 6X4 2/81 50B5 .69 5879 .98  
 6BA7 1.00 6X5 .60 80A5 .69 5879 2.00  
 6BD6 .69 6J6 .67 50L6 .69 6550 3.90  
 6BE6 .59 7N7 .80 KT66 3.29 5654 1.00  
 6BG6 1.50 12A15 .60 80A5 .69 7193 10/81  
 6BH6 .72 12A25 75 80 .69 7193 10/81

**TUBES WANTED! WE BUY! SELL & TRADE!**

**SPECIAL! TRANSISTORS & DIODES!!! FULL LENGTH LEADS**

Factory Tested & Guaranteed!  
 PNP HiPOWER 15 Amp Max 25°C  
 2N441, 2N277 \$1.40 @ 4, \$5, 25/\$28,  
 100/590, 2N442, 2N278 \$3.75 @ 4,  
 4/\$12, 2N547, 100/525, 3 Amp.  
 2N155, 2N156, 2N252, 2N256, 2N323,  
 2N554, TO3GP #80 @ 20 for \$15, 100 for \$65.

2N123 PNP #45 @ 12 for \$5, 100/\$37  
 2N292, 2N293 NPN #45 @ 12 for \$5, 100/\$37  
 2N293 PNP #45 @ 12 for \$5, 100 for \$65  
 2N597, 2N598 PNP \$1.90 ea. @ 6 for \$10  
 2N598 PNP \$1.90. @ 6 for \$10  
 2N599 PNP \$1.90. @ 6 for \$10  
 2N670 PNP/300mw 95c. @ 8 for \$5, 100 for \$48  
 2N671 PNP/1W \$1.15. @ 5 for \$4, 100 for \$69

GENERAL PURPOSE—PNP—COMPUTER GRADE!  
 Use as Amplifier—Oscillator—HIFI  
 Logic—Servo—Power Supply  
 Pulse Amplifier or High Current Switch  
 Veb. Vee. Veb Approx 40V  
 GP 3C rated 300mw e05 @ 10 for \$5, 100 for \$39  
 GP10C rated one watt 90c. @ 6 for \$5, 100 for \$63

2N176 \$1.80, 2N177 \$1, 2N178 \$1.75, 2N247 \$1.50, 2N270 95c, 2N274 \$1.25, 2N408 80c, 2N544 \$1.20, 2N578 \$1.80, 2N579 \$2.20, 2N581 \$1.25, 2N592 \$1.20, 2N750 \$1.40, 2N671 \$2, KIT TRANSISTORS PNP 39c ea., 3 for \$1, ROUND or DIAMOND BASE MICA MET. KIT .30, DELCO POWER HEAT SINK WITH FINS 80 Sq. IN. \$1.25, KIT GLASS DIODES COMPUTER 20c ea., 8 for \$1.

TOP HAT SILICON DIODE EXPERIMENTERS KIT. USE AS STABILIZERS, ZENER DIODES, METER PROTECTION DIODES, CLIPPER & RECTIFIER DIODES! A \$10 VALUE, 8 for \$1, 50 for \$5/PPd.

Qty Discounts to Volume Buyers (\$10 or more this item we pay P.P./U.S.A.)

★ NEW "TEKSEL" SELENIUM RECTIFIERS  
 FULL WAVE BRIDGE RECTIFIERS, ONE YEAR GTDI  
 AMP. 18VDC 28VDC 72VDC 118VDC  
 CONT. 14VDC 28VDC 56VDC 118VDC  
 1AMP \$ 1.30 5 2.00 5 4.90 5 6.50  
 2AMP 2.15 3.00 6.25 12.30  
 3AMP 2.90 4.00 8.50 16.75  
 6AMP 4.15 8.00 18.75 36.15  
 10AMP 6.10 12.15 26.30 48.90  
 Write for Complete Rectifier Catalog

New 24-28VDC Relay Supplies Cased Filtered Ready to Work—15VAC 50 to 800 cps, input  
 B24VAR 24-28VDC @ 1Amp/Filtered & CSD. 10.00  
 B24VER 24-28 VDC @ 2Amps/Filtered & CSD. 14.75  
 B24VJR 24-28VDC @ 6Amps/Filtered & CSD. 27.00

"TAB" KITS! "TAB" THE BEST KITS! "TAB"

All Kits Contain Most Popular Values & Sizes  
 Kit 2 Eng. Parallel Res. Kit 40 Standoff Insulators  
 Kit 35 Precision Resistors Kit 75 Mica Condensers  
 Kit 10 Switches Kit 5 Crystal Diodes  
 Kit 75 Resistors 1/2 & 1/4W Kit 100 Fuses, Assorted  
 Kit 150 Carbon Resistors Kit 100 Ceramic Condensers  
 Kit 12 Electrolytic Cond's Kit 10 Germanium Diodes  
 Kit 56 Tube Sockets Kit 5 FT243 Xtal Holders  
 Kit 65 Tubular Cond's Kit 8 Silicon Diodes  
 Kit 500 Lugs & Eyelets Kit 5 Microswitches  
 Kit 10 Bathtub Oil Cond's Kit 4 Ass'd Selenium  
 Kit Circular Slide Rule Kit 2 Veeder Counters  
 Kit 12 Algor. Clip Asst'd. Kit High Gain X-TAL Mica  
 Kit 5 Sub-Min Tubes

BUY 10 KITS—GET ONE FREE! EACH KIT 99c

NEW SILICON 750MA DIODES TOP GENERAL PURPOSE 400 PIV at 300 MA SPECIAL 2 FOR \$1 20 for \$7

rms/piv 17/25 14c	rms/piv 35/50 19c	rms/piv 70/100 29c	rms/piv 140/200 34c
rms/piv 210/300 43c	rms/piv 280/400 55c	rms/piv 350/500 70c	rms/piv 420/600 82c
rms/piv 490/700 \$1.25	rms/piv 560/800 \$1.50	rms/piv 630/900 \$1.70	rms/piv 700/1000 \$2.00

Low Priced ★ T200 SILICON DIODES rated 380piv/266rms @ 200Ma @ 100°C 36c each; 10 for \$3.25; 100 for \$27; 1000 for \$230

\* CAPACITOR INPUT DERATE 20%: (\$5 or more this item we pay P.P./U.S.A.)

"TAB" TERMS: Money Back Guarantee! Our 15th year. \$2 min. order O.B.N.C. Add shpg charges or for C.O.D. 25¢ Dep. Prices shown subject to change.  
 111-GE LIBERTY ST., N.Y. 6, N.Y.  
 Send 25¢ PHONE: RECTOR 2-6245 for Catalog

**INVENTIONS WANTED**

(Continued from P. 31)

simplicity, accuracy and reliability.

**1382. IDENTIFICATION DEVICE.**—A lightweight device to be carried by small Army aircraft, helicopters and zero-ground-pressure vehicles to permit positive and extremely rapid identification of the vehicles by friendly forward-area anti-aircraft weapons operating primarily against low-flying enemy aircraft. This device should be capable of being carried by ground vehicles for air-to-ground and ground-to-ground identification of these friendly vehicles.

**1407. TIMING DEVICE.**—Develop an accurate (±1%), short-period (5 minutes or less), rugged, inexpensive, highly reliable timing device having long shelf-life capability.

**1425. HIGH-TEMPERATURE FEEDBACK POTENTIOMETER.**—Design a feedback potentiometer for use in the high-temperature (1,000°F) environments associated with missile servos.

**1453. ELECTROMAGNETIC RADIATION WARNING DEVICE.**—Develop a simple, reliable, inexpensive, lightweight instrument which will warn the carrier when he is in an area of electromagnetic energy of a power level of .010 watt/cm<sup>2</sup> or greater. The warning should be of the audible, subaudible (vibratory) or thermal type, depending on the environment in which the instrument is to be used.

**1462. A METHOD FOR OBSERVING THE INSIDE OF BURNING ROCKET MOTORS.**—A technique for the observation of the internal burning process in a solid rocket would be an extremely valuable research tool. The technique need not give rise to a pictorial presentation. Any means by which internal burning processes could be better characterized would be quite useful. To this end, radioactive isotopes should receive strong consideration.

**NEW DEFINITIONS**

A list of 21 new (and possibly official) electronic definitions was released by Raytheon. They are:

**SILENT SERVICE**  
with **QUIETROL**

the first, the quality, the proved silencing "Lubri-Cleaner" for noisy controls and switches on TV, radio and electronic instruments. SPRAY IT or DROP IT... it's easy—efficient—effective. Make QUIETROL your silent partner in providing satisfactory service.

manufactured by **QUIETROL Company**  
SPARTANBURG, South Carolina

In Canada: **CROSS CANADA ELECTRONICS**  
12 Laurel St., Waterloo, Ont.

Damped oscillation—end of a rock 'n roll party  
 Inertial guidance—permissive parenthood, or leaving well enough alone  
 Countermeasures—Dr. Spock's system, the opposite of inertial guidance  
 Thermistor—a hot engineer  
 Semiconductor—railway official under 5 foot 2  
 Telemetering—why women need unlimited phone service  
 Esaki diode—verses read at a Tokyo wake  
 Triode—what the beat poet writes  
 Condenser—designer of midget radios  
 END

**Answer to Electronics Numbers Puzzle on Page 68**

1 5 7 5 0 6 0 0  
 9 6 5 2 2 0 7 3  
 8 1 0 0 9 0 0 1 5 11 2 5  
 12 5 4 13 14 15 6 16 7 8  
 7 17 4 5 18 1 0 19 1 2  
 3 20 0 0 5 21 9 5 0  
 22 4 23 3 24 1 8 9 5  
 25 26 8 0 B 27 5  
 28 7 0 0 8 0 3 0 0 3  
 0 1 0 0 0 1  
 33 7 5 2 35 36 4 6 37 38 5 0 0 0  
 7 40 9 3 9 0 4

**ENGINEERING DEGREE IN SCIENCE MATH 27 or 36 MOS.**

B.S. degree—36 mos. • B.E. degree—27 mos.  
 Accelerated year-round program prepares for early employment in fields of Science and Engineering. Regular 4-year program for B.S. Degree completed in 36 months, special engineering degree program in 27. Classes start June, July, September, January, March. Quality education. Graduates employed from coast to coast. Government approved for veteran training. Students from 50 states, 40 countries, 20 buildings; dorms, gym, Campus. Save time and money. Earn board. Write for catalog, 1751 E. Washington Boulevard, Fort Wayne 2, Indiana

**INDIANA TECHNICAL COLLEGE**

**GOOD PRICES FOR GOOD PHOTOGRAPHS**  
 RADIO-ELECTRONICS / 154 West 14th St. New York 11, N.Y.

**HI-FI RECORDING TAPE**  
 Splice Free (except 2400')  
 15 day money-back guarantee

1200' 7" Acetate	51.29	51.17	99c
1800' 7" acetate	1.79	1.59	1.45
1800' 7" mylar	2.09	1.99	1.85
2400' 7" mylar	2.99	2.89	2.49
2400' 7" tonalized mylar	4.25	3.95	3.75

Can Be Assorted. Add 15c Postage Per Reel.  
 10c For 24' Lot Orders.  
 HI-FI COMPONENTS TAPE RECORDERS available from wide variety of stock and shipped within 24 hours. Write for free wholesale catalogue. \*WE WILL NOT BE UNDERSOLD.\* Write us and see why.  
**CARSTON** 125-RD East 88 St. New York, 28, N. Y.

**R-E****Classified****ADS**

**Rates—50¢ per word (including name, address and initials. Minimum ad 10 words. Cash must accompany all ads except those placed by accredited agencies. Discount, 10% for 12 consecutive issues. Misleading or objectionable ads not accepted. Copy for July issue must reach us before May 10, 1961.**

**RADIO-ELECTRONICS, 154 West 14 St., New York 11, N. Y.**

**DRAW, UNDERSTAND SCHEMATICS,** Blueprint reading \$2. Special Edition "Encyclopaedia, Drawing, Design" \$9. **LOUIS PRIOR,** 23-09 169th St., White-stone 57, N.Y.

**GARAGE DOOR OPERATOR** \$59.95. Rugged chain drive automatic unit. High-est Quality. Free Literature. **DEMSCO, INC.,** Sebring 21, Ohio.

**USED CORRESPONDENCE COURSES,** Books Bought, Sold, Rented, Catalog Free. **VERNON,** Summerville, Ga.

**START YOUR FIRE ALARM BUSINESS** with our fire alarm 5½"x2¼"x1¼" \$66 per doz., and micro thermal switches \$18 per dozen; maximum profit, minimum invest-ment, fully guaranteed. **KAMCO-ELEC-TROCHEM CO.,** 2712 N. Magnolia Ave., Chicago 14, Ill.

**RENT STEREO TAPES—**over 2,000 dif-ferent—all major labels—free catalog. **STEREO-PARTI,** 811-RE, Centinela Ave., Inglewood 3, Calif.

**6 TRANSISTOR RADIOS,** finest made. Send \$14.95 for sample, accessories in-cluded. Send \$8.95 for sample 5 tube radio with phone and mike input. **MYERS,** 623 Gay, Knoxville, Tenn.

**BEFORE YOU BUY** Receiving Tubes or Hi-Fi Components send now for your giant **FREE Zalytron** current catalog—featuring nationally known Zalytron First Quality TV-Radio Tubes, Hi-Fi Stereo Systems, Kits, Parts, etc. All priced to Save You Plenty—Why Pay More? **ZALYTRON TUBE CORP.,** 220 W. 42nd St., N.Y.C.

**JAPANESE TRANSISTOR RADIOS RE-PAIRED.** \$5. postpaid, **CHAS BROWN,** 6114 Wissahickon, Philadelphia 44, Pa.

**GET THE LATEST** issue of the **SCHWANN LONG PLAYING CATALOG** at your record dealer's now. A complete monthly 256-page guide to all widely available re-corded music, it lists over 25,000 monaural and stereo records, including over 550 new releases each month. If your record dealer doesn't carry it, send 35¢, with your name and address and name and address of your dealer, to **W. SCHWANN, INC.,** 137 New-bury St., Boston 16, Mass.

**NEW CONCEPT OF LEARNING SELF-HYPNOSIS!** Now on tape or record! Free Literature. **McKINLEY-SMITH CO.,** Dept. T5, Box 3038, San Bernardino, Calif.

**EAVESDROP** with a pack of cigarettes. Miniature transistorized FM Radio Trans-mitter. Complete diagrams and instruc-tions \$2. **A. CARRIER CO.,** 5880 Holly-wood Blvd., Hollywood 28, Calif.

**C-B Intercom** operates from remote loca-tion. **FRONTIER ELECTRONICS,** Orr 3, Minn.

**ELECTRONIC KITS** constructed wired, and tested. Satisfaction guaranteed. **J. R. SIMPSON** 46A Cedar St., Waltham, Mass.

**PROFESSIONAL ELECTRONIC PROJ-ECTS—**Organs, Timers, Computers, etc.—\$1 each. List Free. **PARKS,** Box 1665, Lake City Station, Seattle 55, Wash.

**HAVE A BALL** with foolproof lie detector. Plans \$1. **DEE CO.,** Box 7263, Houston, Texas.

**PROMPT DELIVERY,** we will not be un-der-sold. Amplifiers, Tape Recorders, Tun-ers, etc. No. Catalogs. Air Mail Quotes. Compare. **L. M. BROWN SALES CORP.,** Dept. R-239, East 24th St., New York 10, N.Y.

**PRINTING PRESSES,** Type, Supplies, Lists 4c. **TURNBAUGH SERVICE,** Mecha-nicsburg, Penna.

**HI-FI PROBLEMS SOLVED** on-the-spot by "The Hi-Fi Doctor". Audio, Acoustic, Radio Engineer. Professional visits, day, evening, New York area. **WILLIAM BOHN,** Plaza 7-8569.

**WANTED: SIGNAL GENERATOR,** Jack-son Model T V G - 2. **SANDY'S RADIO,** 821 General Arnold, Sarasota, Fla.

**LEARN WHILE ASLEEP,** Hypnotize with your recorder, phonograph or amazing new Electronic Educator endless tape recorder. Catalog, details free. **SLEEP-LEARNING ASSOCIATION,** Box 24-RD, Olympia, Wash.

**NEWS PHOTOS WANTED:** Identification-Press card available. **ACCREDITED PRESS,** Lawrence 7, N.Y.

**DISCOUNTS UP TO 50%** on Hi-Fi ampli-fiers, tuners, speakers, tape recorders, individual quotations only, no catalogs. **CLASSIFIED HI-FI EXCHANGE,** 2375 East 65th Street, Brooklyn 34, N.Y.

**DIAGRAMS, SERVICING INFORMATION,** Practically any radio, television, \$1, post-paid. Specify manufacturer, model. **SU-PREME PUBLICATIONS,** 1760 Balsam, Highland Park, Ill.

**DON'T BUY HI-FI COMPONENTS,** Kits, Tape, Tape Recorders until you get our low, low return mail quotes. "We Guar-antee Not To Be Undersold." Wholesale Catalog Free. **HI-FIDELITY CENTER,** 220 RC E 23 st., New York 10, N.Y.

**POLICE RADAR DETECTOR.** Stop before those radar speed traps. Fool proof, legal system. Complete diagrams and instruc-tions \$2.75. **A. CARRIER CO.,** 5880 Holly-wood Blvd., Hollywood, 28, Calif.

**CASH PAID!** Sell your surplus electronic tubes. Want unused, clean radio and TV receiving, transmitting, special purpose, Magnetrons, Klystrons, broadcast types, etc. Want military & commercial lab/test and communications equipment such as G.R., H.P., AN/UPM prefix. Also want commercial receivers and transmitters. For a fair deal write **BARRY,** 512 Broad-way, New York 12, N. Y. **WALKER** 5-7000.

**MANUFACTURER'S CLOSEOUT.** Transis-tor Radio Kit—2 transistors plus 1 diode. Earpiece and whip antenna. Easy to as-semble \$2.50. Phonograph kit—two speed 33 and 45 RPM. Complete with motor board, crystal pick-up and amplifier com-ponents and speaker. \$9.95. **NEW YORKER INDUSTRIES,** 350 Scotland Rd., Orange, N.J.

**AMPEX, Concertone, Crown, Magnecord, Presto, Norelco, Bogen, Tandberg, Sher-wood, Rek-O-Kut, Scott, Shure, Dynakit, others . . . Trades.** **BOYNTON STUDIO,** Dept. RE, 10 Pennsylvania Ave., Tuckahoe, N.Y.

**EMBOSSER BUSINESS CARDS —**\$3.95 per 1000-Samples; **EDWARD PRINTING SERVICE,** 7430 Selwick Drive, Parma, 29, Ohio.

**ALL MAKES OF ELECTRICAL INSTRU-MENTS AND TESTING** equipment re-paired. New and used instruments bought, sold, exchanged. **HAZELTON INSTRU-MENT CO.,** 128 Liberty Street, New York, N.Y.

**HEARING AIDS** loaded with sub-miniature parts \$2. Operating condition \$10. **BETTER HEARING CENTER—**116 S. Michigan, Chi-cago, Ill.

**COMPONENTS, Recorders, Tapes. FREE Wholesale Catalogue.** **CARSTON,** 125-T East 88th St., New York 28, N.Y.

**LEARN ABOUT TECHNICAL WRITING.** New book tells how. **M. & W.,** Box 98, Mendon, N.Y.

**GUARANTEED COMPONENTS** Below net prices. **BIGELOW ELECTRONICS,** Box 1, Bluffton, Ohio.

**SPOKEN WORD TAPES.** Swap, sell or rent me yours. Send list. **ED MISHKIN** 117 Merion Road, Merion, Pa.

**SCHEMATICS,** repair information. Radios —Amplifiers—Recorders 75¢. Television \$1.50. Send make & model. **STECKLER,** 223-21 65th Ave., Bayside 64, N. Y.

**WANTED—MISCELLANEOUS** Quicksilver Platinum, Gold, Silver. Ores analyzed. **MERCURY TERMINAL,** Norwood, Mass.

**CATALOGS GENERAL MERCHANDISE,** also specials, closeout. \$1 refundable. **WHOLESALE CATALOGS, RE-2569** North 12th St., Milwaukee 6, Wisc.

**TRANSISTORIZED** products dealers cata-log, \$1. **INTERMARKET, CPO** 1717, Tokyo, Japan.

**GIANT SURPRISE PACKAGE.** 5 lbs. \$4.95. "Antenna-Repair Pocket Field Glasses", \$14.95, C.O.D. **TWECO ELECTRONIC CO.,** P.O. Box 155, Indio, Calif.

**ELECTRONICS BY SLEEP TEACHING.** The thorough way to train. Catalog 25¢. **ELECTRO-SLEEP,** 8959 Wonderland Ave., Los Angeles 46, Calif.

**DIAGRAMS FOR REPAIRING RADIOS,** television \$2. Give make and Model. **DI-A-GRAM SERVICE,** Box 672 RE, Hartford 1, Conn.

# new BOOKS

**ELECTRONIC EQUIPMENT RELIABILITY**, by G. W. A. Dummer and N. Griffin. John Wiley & Sons Inc., New York, N. Y. 5 1/2 x 8 1/2 in. 274 pp. \$7.50.

The complexity of electronic circuits continues to grow rapidly, and the chance of breakdown increases still faster. An expensive device like a computer or a satellite can be put out of operation by failure of a single component out of many thousands.

The authors analyze the causes of failure in components, tubes and circuits. Numerous charts show the effects of temperature, vibration, radiation, design, storage and other factors. A number of preferred circuits are described and recommended for maximum reliability and simpler maintenance. Solderless connections, printed wiring, derating, testing, miniaturization and sealing are among the topics. Later chapters tell how to design and test for maximum reliability.—IQ

**FROM MICROPHONE TO EAR (2nd Edition)**, by G. Slot. MacMillan Co., 60 Fifth Ave., New York 11, N. Y. 5 1/2 x 8 in. 258 pp. \$4.50.

This practical book describes components, techniques and care of sound equipment. Tape and disc are completely covered for the benefit of technicians and music-lovers. The book contains much useful information on the characteristics of pickups, record changers and speakers. The care of styli and records receive special attention, as do stereo and tape recording.—IQ

**SUCCESSFUL PREPARATION FOR FCC RADIO OPERATOR LICENSE EXAMINATIONS**, by Darrell L. Geiger. Prentice-Hall, Inc., Englewood Cliffs, N. J. 6 x 9 in. 689 pp. \$8.95.

This book covers all elements needed to pass a commercial radio operator's license examination. It lists all questions (and their answers) likely to be asked by the FCC. All answers are explicit and complete, with diagrams appearing where applicable.

As pointed out by the author, the student is presumed to have a good basic knowledge of theory and code before taking the exam. Suggested textbooks are listed, as well as Q signals and abbreviations. License requirements, study hints and where to take the exam are also covered.—IQ

**REPAIRING TRANSISTOR RADIOS**, by S. Libes. John F. Rider Publisher Inc., 116 West 14th St., New York 11, N. Y. 5 1/2 x 8 1/2 in. 159 pp. \$3.50.

This practical book is especially suitable for beginners. It analyzes the separate circuits of a transistor radio, shows how to adjust and repair them, lists quick tests and servicing charts. Portable and auto sets are emphasized.

Several representative schematics

# SCHOOL DIRECTORY

## MATHEMATICS MADE EASY

by new step-by-step home study method. Courses from elementary to advanced level. Fees as low as \$10. Diploma awarded. Free booklet by Prof. Allcut, P. Eng., gives complete details. Write today to **CANADIAN INSTITUTE OF SCIENCE & TECHNOLOGY LTD.**, 412 5th St. N.W., Washington, D.C.

## Learn Transistor Electronics At Home!

■ Prepare now for a profitable career in this growing field. Learn theory, construction and applications of all types of transistors with this proven home-study course from the Philco Technological Center.

FOR FREE INFORMATION PLEASE WRITE TO:

**PHILCO**  
TECHNOLOGICAL CENTER  
"C" and Ontario Sts., Philadelphia 34, Pa.

FREE!

## ELECTRONICS CAREER KIT

If you're interested in breaking into a good-paying job in Radio-TV-Electronics, I.C.S. will send you absolutely free a famous Career Kit with 3 famous booklets that have helped thousands of others — just like yourself — on the road to real success. Includes:

- 1 "HOW TO SUCCEED" Career Guide — 36-page gold mine of career tips and information.
- 2 "JOB CATALOG" of opportunities in your field of interest.
- 3 "SAMPLE LESSON" (math) to demonstrate the famous I.C.S. method.

Send today for your free I. C. S. Career Kit with these 3 famous booklets. There's no obligation. This may be the big break you've been waiting for. Mark and mail the coupon today.

### INTERNATIONAL CORRESPONDENCE SCHOOLS

Dept. 37087D Scranton 15, Penna.

Please send free Career Kit with 3 famous booklets

- |   |  |   |
|---|--|---|
| <input type="checkbox"/> General Electronics    | <input type="checkbox"/> Radio-TV Serv'g     | <input type="checkbox"/> Practical Electrician  |
| <input type="checkbox"/> Industrial Electronics | <input type="checkbox"/> Sound Equip. Serv'g | <input type="checkbox"/> Profess'l Eng. (Elec.) |
| <input type="checkbox"/> Radio-TV Eng'g         | <input type="checkbox"/> Electrical Eng'g    | <input type="checkbox"/> Electrical Drafting    |
| <input type="checkbox"/> Electronic Servicing   | <input type="checkbox"/> Electrical Tech.    | <input type="checkbox"/> Other                  |

Name \_\_\_\_\_ Age \_\_\_\_\_

Address \_\_\_\_\_

City \_\_\_\_\_ State \_\_\_\_\_

## SCIENCE ENGINEERING

B.S. Degree—36 mos. • B.E. Degree—27 mos.  
Accelerated year-round program: Aero., Chem., Civil, Elec., Mech., Metal., Math., Chem., Physics. Modest rate. Earn board. New classes start June, July, Sept., Jan., Mar. Catalog. 1551 E. Washington Blvd., Fort Wayne 2, Ind.

## INDIANA TECHNICAL COLLEGE

### double your income with degree

A college education is a good investment! More rapid advancement, too. Important firms like Tri-State College graduates . . . return regularly to interview seniors on campus. Become an Electronics Engineer. Qualify faster here.

### Bachelor of Science Degree in 27 Months

In Electrical (Electronics or Power major), Mechanical, Chemical, Aeronautical, Civil Engineering. IN 36 MONTHS B.S. in Business Administration (General Business, Accounting, Motor Transport Management Majors). For earnest, capable, mature students. Small classes. More professional class hours. Beautiful campus. Well-equipped labs, modernized buildings, new dorms. Year-round operation. Enter June, Sept., Jan., Mar. Founded 1884. Write J. G. McCarthy, Director Admissions, for Catalog and "Your Career in Engineering and Commerce" Book.

2451 College Avenue  
Angola, Indiana

## ELECTRONICS

PREPARE FOR A GOOD JOB!  
BROADCAST ENGINEER  
RADIO SERVICING AUTOMATION

TELEVISION SERVICING  
BLACK & WHITE—COLOR

APPROVED FOR VETERANS AND SURVIVORS  
OF VETERANS  
BUILDING AIR CONDITIONED  
SEND FOR FREE LITERATURE

BALTIMORE TECHNICAL INSTITUTE  
1425 EUTAW PLACE, BALTIMORE 17, MD.

## ENGINEERING COURSES



E.E.  
Option Electronics or Power  
Mechanical, Civil & Physics  
Also in Liberal Arts  
presented through

### HOME STUDY

Resident Classes Also  
Available if Desired  
Specify course desired.

PACIFIC INTERNATIONAL  
COLLEGE OF ARTS  
& SCIENCES

Primarily a correspondence  
school

5719-M Santa Monica Blvd. Hollywood 38, Calif.

## GET INTO ELECTRONICS

V.T.I. training leads to success as technicians, field engineers, specialists in communications, guided missiles, computers, radar and automation. Basic and advanced courses in theory and laboratory. Assoc. degree in electronics in 20 mos. B.S. in electronic engineering obtainable. ECPE accredited, G.I. approved. Graduates in all branches of electronics with major companies. Start September, February. Dorms, campus. High School graduate or equivalent. Catalog.

VALPARAISO TECHNICAL  
INSTITUTE  
Dept. C Valparaiso, Indiana



# SCHOOL DIRECTORY

## LEARN ELECTRONIC ORGAN SERVICING

This new, high paying profession can now be learned easily in your spare time.

- ★ Complete Training — All Makes and Models
- ★ Scientific Teaching Aids Make Learning Easy
- ★ No Prior Knowledge of Electronics Necessary

GET FULL DETAILS ON THIS AMAZING COURSE

WRITE FOR FREE BOOKLET

**NILES BRYANT SCHOOL**  
Dept. L, 3731 Stockton Blvd.  
Sacramento 20, California

## ELECTRONIC TECHNICIANS!

Raise your professional standing and prepare for promotion!  
Win your diploma in  
**ENGINEERING MATHEMATICS**  
from the  
Indiana Home Study Institute

We are proud to announce two great new courses in Engineering Mathematics for the electronics industry.

These unusual courses are the result of many years of study and thought by the President of Indiana Home Study, who has personally lectured in the classroom to thousands of men, from all walks of life, on mathematics, and electrical and electronic engineering.

You will have to see the lessons to appreciate them!

NOW you can master engineering mathematics, and actually enjoy doing it!  
WE ARE THIS SURE: you sign no contracts—you pay only AFTER you have completed each Unit of your course.

In plain language, if you aren't satisfied you don't pay, and there are no strings attached.

Write today (a postcard will be fine), for more information and your outline of courses.

You have nothing to lose, and everything to gain!

The INDIANA Home Study Institute  
924 E. Columbia Ave., Fort Wayne, Indiana

LEARN RADAR MICROWAVES COMPUTERS—TRANSMITTERS CODE • TV • RADIO  
Phila. Wireless Technical Inst. 1533 Pine St., Philadelphia 2, Pa.  
A Non-Profit Corp. Founded in 1908  
Write for Free Catalog to Dept. RE-5  
Classes now forming

ENGINEERING EDUCATION for the Space Age  
NORTHROP INSTITUTE of Technology is a privately endowed, nonprofit college of engineering offering a complete Bachelor of Science Degree Program and TWO-YEAR accredited technical institute curricula. Students from 50 states, many foreign countries. Outstandingly successful graduates employed in aeronautics, electronics, and space technology. Write today for catalog—no obligation.  
NORTHROP INSTITUTE OF TECHNOLOGY  
1181 West Arbor Vitae Street, Inglewood 1, California  
Study in the "Valley of the Sun"  
**ELECTRONIC ENGINEERING TECHNOLOGY**  
College-level resident schooling  
Veteran-approved. Catalog on request  
Middleton Institute of Electronics  
2937 E. McDowell Rd.  
PHOENIX ARIZONA

## ENGINEERING HOME STUDY COURSES

Courses written by world authorities in all branches of engineering and science and proved successful by thousands of our graduates. One hour each day in your spare time will start you off to higher pay, security and prestige. Personalized instruction methods ensure rapid progress. Fill in the coupon and indicate the course of interest. We will send you a complete outline of the course and a booklet describing the Institute and our advanced teaching methods.

- RADIO
- ELECTRONICS
- TELEVISION
- CIRCUIT
- MATHEMATICS
- ELECTRICAL ENG.
- TELEPHONY
- CIVIL ENG.
- SURVEYING
- ARCHITECTURE
- FORESTRY
- MINING
- STRUCTURAL
- MECHANICAL ENG.
- INDUSTRIAL ENG.
- & MANAGEMENT
- REFRIGERATION
- DRAFTING
- PLASTICS
- AERONAUTICAL ENG.
- HIGH SCHOOL
- CHEMICAL
- MATHEMATICS
- JOURNALISM
- ACCOUNTING

MAIL THIS COUPON TODAY

CANADIAN INSTITUTE OF SCIENCE & TECHNOLOGY LIMITED  
768 Century Bldg., 412, 5th St. N.W., Wash., D.C.

NAME.....

ADDRESS.....

CITY.....STATE.....

COURSE OF INTEREST.....

Canadians: Send to C.I.S.T., 768 Garden Bldg., 263 Adelaide St. West, Toronto, Ontario.

C. I. S. T.

FREE CAREER BOOKLET

YOUR CAREER

M.S.O.E.

to guide you to a successful future in  
**ELECTRONICS RADIO-TV COMPUTERS ELECTRICAL ENGINEERING**

This interesting pictorial booklet tells you how you can prepare for a dynamic career as an Electrical Engineer or Engineering Technician in many exciting, growing fields:  
**MISSILES • RADAR • RESEARCH ELECTRICAL POWER • ROCKETRY AUTOMATION • AVIONICS SALES • DEVELOPMENT**

Get all the facts about job opportunities, length of study, courses offered, degrees you can earn, scholarships, part-time work — as well as pictures of the Milwaukee School of Engineering's educational and recreational facilities. No obligation — it's yours free.

MILWAUKEE SCHOOL OF ENGINEERING

MAIL COUPON TODAY!

MILWAUKEE SCHOOL OF ENGINEERING  
Dept. RE-561, 1025 N. Milwaukee St.  
Milwaukee, Wisconsin MS-113

Please send FREE "Your Career" booklet  
I'm interested in  Electronics  Radio-TV  
 Computers  Electrical Engineering  
 Mechanical Engineering  
(PLEASE PRINT)

Name.....Age.....

Address.....

City.....Zone.....State.....

I'm eligible for veterans education benefits.  
Discharge date.....

# TV TUNER OVERHAUL



ALL MAKES  
ONE PRICE  
**\$9.95**

VHF TUNERS • UHF TUNERS • UV Combinations\*

Castle overhaul charge includes all labor and minor parts and written 90 day warranty. Tubes and major parts are extra at net prices. Tuner to be overhauled should be shipped complete; include tubes, shield cover and any damaged parts. Write down model number and state complaint. Pack well and insure.

Castle, pioneers of TV Tuner overhauling, assure the best service available. Remember, Castle has a decade of experience and overhauling tuners is our only business.

\*UV combination tuner must be of one piece construction. Separate UHF and VHF tuners must be dismantled and the defective unit only sent in.

**SAME DAY SERVICE!**

On Popular Types  
48 Hours most others

*Castle*

**TV TUNER SERVICE, INC.**

5710 N. Western Ave. • Chicago 45, Illinois  
In Canada: 136 Main Street • Toronto 13, Ontario

**ADD TO YOUR INCOME**

**Learn at Home to Fix  
APPLIANCES**

**FREE  
SAMPLE  
LESSON**

Tester Furnished—No Extra Charge. National Radio Institute trains you at home. Every service customer is worth more when you can fix his electrical appliances. Mail coupon for Lesson and Catalog.

National Radio Inst., Dept. FE1, Washington 16, D.C.  
Please send me Electrical Appliance Sample Lesson and Catalog FREE (No salesman will call).

Name.....Age.....  
Address.....  
City.....Zone.....State.....  
ACCREDITED MEMBER NATIONAL HOME STUDY COUNCIL

**FREE!** CATALOG OF  
HI-FI, RADIO, TV  
PARTS & ACCESSORIES —  
*yours for the asking!*

**Vidaire** ELECTRONICS MFG. CORP.  
365 BABYLON TPKE. — ROOSEVELT, N. Y.

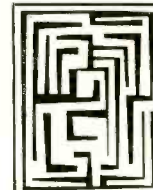

**YOU'LL BE  
AMAZED...**

at our low, low hi-fi prices. Write for FREE discount catalog A-12, or send for our special quotations on your component needs.

KEY ELECTRONICS COMPANY  
120 Liberty St., New York 6, N. Y.

Ask By Name For  
**GENUINE**

**"NO NOISE"  
PRODUCTS**

your assurance  
of brand name  
quality

**NO-NOISE  
Volume Control  
and CONTACT RESTORER**  
Cleans • Lubricates • Protects  
Not a Carbon Wet Solution  
2 oz. Bottle **\$1.00** Net to Servicemen  
6 oz. Spray Can **\$2.25** Net to Servicemen



**NO-NOISE  
TUNER-TONIC  
with PERMA-FILM**  
Cleans, lubricates, restores all  
tuners, including water type.  
Non-toxic, non-inflammable.  
For TV, radio and FM use.  
Economical—a little does a lot.  
6 oz. Aerosol Can **\$3.25** Net to Servicemen



**FREE**  
at your  
jobbers

**5" PLASTIC  
EXTENDER**

included with  
each can



- Push Button Assembly
- For Pin-Point Applications
- Does Not Cause Shorts

**ELECTRONIC CHEMICAL CORP.**

813 Communipaw Avenue Jersey City 4, N. J.

**the  
business-like  
approach**

to  
SERVICE  
CHARGES  
and  
RECORD  
KEEPING



For customer's prices on every replacement part, plus flat rate and hourly service charge data, regional and national. Dave Rice's OFFICIAL PRICING DIGEST, listing over 63,000 items. \$2.50.

▲ AVAILABLE FROM YOUR DISTRIBUTOR ▼

If you want to operate on a professional level, Dave Rice's OFFICIAL ORDER BOOKS give you triplicate forms for order, invoice, and office records... spaces for tubes, parts, serial numbers, labor and tax charges, signatures, etc. 75c per book, \$6.50 for dust-proof box of 10.



*Dave Rice's*

**ELECTRONIC PUBLISHING COMPANY, INC.**  
180 N. WACKER DRIVE • CHICAGO 6, ILL.

appear in the book, and are analyzed by the author. He also includes chapters on troubleshooting and test equipment.—IQ

**ELECTRONIC COMPUTERS (2nd edition),** by T. E. Ivall. Philosophical Library, 15 E. 40 St., New York, N. Y. 5 1/2 x 8 1/2 in. 263 pp. \$15.

This new edition brings its subject matter up to date. The text is largely nonmathematical and is suitable for readers who know radio techniques. Both digital and analog computers are discussed, and typical equipment is described and illustrated.

Circuitry, construction and application of all types are well covered. The book ends with more recent developments and the possibilities of designing a "thinking" machine in the future. Students, technicians and engineers will find this text helpful as an introduction and as a guide.—IQ

**BASICS OF ANALOG COMPUTERS,** by T. D. Truitt and A. E. Rogers. John F. Rider Publisher Inc., 116 W. 14 St., New York 11, N. Y. 6 1/2 x 9 in. 378 pp. \$12.50.

This is a picture text course on the modern computer. Many types are described but emphasis is on the dc analog computer. Basic theory and equations are developed at a pace easy for college students, engineers, maintenance technicians and others. Illustrations and diagrams clarify principles and applications. Review questions are included.—IQ

**1960 NORTHEAST ELECTRONICS RESEARCH and ENGINEERING MEETING RECORD.** Published by Lewis Winner. Available from Boston Section IRE, 313 Washington St., Newton 58, Mass. 8 1/4 x 11 in. 190 pp. \$7.50.

This record contains digests of technical papers delivered at 40 technical sessions of the 1960 Northeast Electronics Research and Engineering Meeting held in Boston, Mass., in November. A wide variety of topics are discussed and illustrated. They include transistors, antennas, microwaves, circuits, space electronics, standards and measurements.—IQ

END

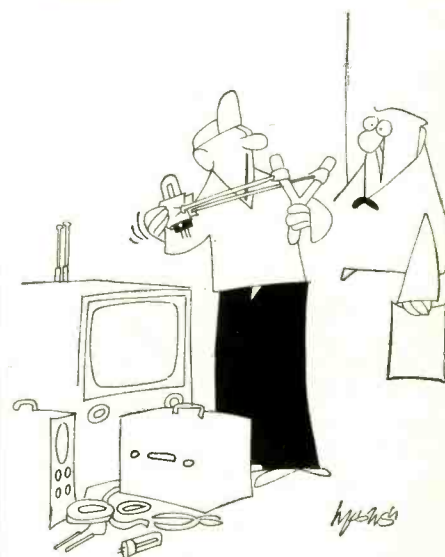

"First of all, we'll get rid of the bad tubes."



BEFORE You Buy Tubes . . .

**COMPARE**

Rad-Tel's  
money-saving  
low prices . . .

> **UP TO 75% OFF**

**COMPARE**

Rad-Tel's  
dependability . . .

> **BRAND NEW TUBES**

**COMPARE**

Rad-Tel's  
reliable . . .

> **ONE FULL YEAR  
GUARANTEE**

**COMPARE**

Rad-Tel's . . .

> **RELIABLE PERFORMANCE**

**SERVICEMEN:** Now speedy one-day service.

Rad-Tel sells only Brand New Tubes, not used, not pulled out of old sets . . . reduce costly call backs.

**THE SIGN OF RAD-TEL'S RELIABILITY**



Qty.	Type	Price
—	0Z4M	.79
—	1AX2	.62
—	1B3GT	.79
—	1DN5	.55
—	1G3	.79
—	1J3	.79
—	1K3	.79
—	1LN5	.59
—	1R5	.62
—	1S5	.51
—	1T4	.58
—	1U4	.57
—	1U5	.50

Qty.	Type	Price
—	5CL8	.76
—	5EA8	.80
—	5EU8	.80
—	5J6	.68
—	5T8	.81
—	5U4	.60
—	5U8	.81
—	5V6	.56
—	5X8	.78
—	5Y3	.46
—	6AB4	.46
—	6AC7	.96

**EACH TUBE INDIVIDUALLY & ATTRACTIVELY BOXED**

Qty.	Type	Price	Qty.	Type	Price	Qty.	Type	Price
—	6AU7	.61	—	6SK7	.74	—	12CN5	.56
—	6AU8	.87	—	6SL7	.80	—	12CR6	.54
—	6AV6	.40	—	6SN7	.65	—	12CU5	.58
—	6AW8	.89	—	6SQ7	.73	—	12CU6	1.06
—	6AX4	.65	—	6T4	.99	—	12CX6	.54
—	6AX7	.64	—	6U8	.78	—	12DB5	.69
—	6BA6	.49	—	6V6GT	.54	—	12DE8	.75
—	6BC5	.54	—	6W4	.54	—	12DL8	.85
—	6BC7	.94	—	6W6	.69	—	12DM7	.67
—	6BC8	.97	—	6X4	.39	—	12DQ6	1.04
—	6BD6	.51	—	6X5GT	.53	—	12DS7	.79
—	6BE6	.55	—	6X8	.77	—	12DZ6	.56
—	6BF6	.44	—	7AU7	.61	—	12EL6	.50
—	6BG6	1.66	—	7A8	.68	—	12EG6	.54
—	6BH6	.65	—	7B6	.69	—	12EZ6	.53
—	6BH8	.87	—	7Y4	.69	—	12F8	.66
—	6BJ6	.62	—	8AU8	.83	—	12FM6	.45
—	6BK7	.85	—	8AW8	.93	—	12K5	.65
—	6BL7	1.00	—	8BQ5	.60	—	12SA7M	.86
—	6BN4	.57	—	8CG7	.62	—	12SK7GT	.74
—	6BN6	.74	—	8CM7	.68	—	12SN7	.67
—	6BQ5	.65	—	8CN7	.97	—	12SQ7M	.73
—	6BQ6GT	1.05	—	8CX8	.93	—	12U7	.62
—	6BQ7	.95	—	8EB8	.94	—	12V6GT	.53
—	6BR8	.78	—	11CY7	.75	—	12W6	.69
—	6BU8	.70	—	12A4	.60	—	12X4	.38
—	6BY6	.54	—	12AB5	.55	—	17AX4	.67
—	6BZ6	.54	—	12AC6	.49	—	17BQ6	1.09
—	6BZ7	.97	—	12AD6	.57	—	17C5	.58
—	6C4	.43	—	12AE6	.43	—	17CA5	.62

Qty.	Type	Price	Qty.	Type	Price	Qty.	Type	Price
—	6CB6	.54	—	12AF3	.73	—	17D4	.69
—	6CD6	1.42	—	12AF6	.49	—	17DQ6	1.06
—	6CF6	.64	—	12AJ6	.46	—	17L6	.58
—	6CG7	.60	—	12AL5	.45	—	17W6	.70
—	6CG8	.77	—	12AL8	.95	—	19AU4	.83
—	6CM7	.66	—	12AQ5	.52	—	19BG6	1.39
—	6CN7	.65	—	12AT6	.43	—	19T8	.80
—	6CR6	.51	—	12AT7	.76	—	21EX6	1.49
—	6CS6	.57	—	12AU6	.50	—	25BQ6	1.11
—	6CU5	.58	—	12AU7	.60	—	25C5	.53
—	6CU6	1.08	—	12AV5	.97	—	25CA5	.59
—	6CY7	.71	—	12AV6	.41	—	25CD6	1.44
—	6DA4	.68	—	12AV7	.75	—	25CU6	1.11

**RAD-TEL TUBE CO.**

**NOT AFFILIATED WITH ANY OTHER MAIL ORDER TUBE COMPANY**

Qty.	Type	Price
—	1X2B	.82
—	2AF4	.96
—	3AL5	.42
—	3AU6	.51
—	3AV6	.41
—	3BA6	.51
—	3BC5	.54
—	3BE6	.52
—	3BN6	.76
—	3BU8	.78
—	3BY6	.55
—	3BZ6	.55
—	3CB6	.54
—	3CF6	.60

Qty.	Type	Price
—	3CS6	.52
—	3DK6	.60
—	3DT6	.50
—	3Q5	.80
—	3S4	.61
—	3V4	.58
—	4BC8	.96
—	4BN6	.75
—	4BQ7	.96
—	4BS8	.98
—	4BU8	.71
—	4BZ6	.58
—	4BZ7	.96

Qty.	Type	Price
—	4CS6	.61
—	4DE6	.62
—	4DK6	.60
—	4DT6	.55
—	5AM8	.79
—	5AN8	.86
—	5AQ5	.52
—	5AT8	.80
—	5BK7A	.82
—	5BQ7	.97
—	5BR8	.79
—	5CG8	.76

Qty.	Type	Price
—	6AF3	.73
—	6AF4	.97
—	6AG5	.65
—	6AH6	.99
—	6AK5	.95
—	6AL5	.47
—	6AM8	.78
—	6AQ5	.50
—	6AR5	.55
—	6AS5	.60
—	6AT6	.43
—	6AT8	.79
—	6AU4	.82
—	6AU6	.50

Qty.	Type	Price
—	6DB5	.69
—	6DE6	.58
—	6DG6	.59
—	6DQ6	1.10
—	6DT5	.76
—	6DT6	.53
—	6EU8	.79
—	6EA8	.79
—	6H6GT	.58
—	6J5GT	.51
—	6J6	.67
—	6K6	.63
—	6S4	.48
—	6SA7GT	.76

Qty.	Type	Price
—	12AX4	.67
—	12AX7	.63
—	12AZ7	.86
—	12B4	.63
—	12BA6	.50
—	12BD6	.50
—	12BE6	.53
—	12BF6	.44
—	12BH7	.73
—	12BL6	.56
—	12BQ6	1.06
—	12BY7	.74
—	12BZ7	.75
—	12C5	.56

Qty.	Type	Price
—	25DN6	1.42
—	25EH5	.55
—	25L6	.57
—	25W4	.68
—	25Z6	.66
—	35C5	.51
—	35L6	.57
—	35W4	.52
—	35Z5GT	.60
—	50B5	.60
—	50C5	.53
—	50DC4	.37
—	50EH5	.55
—	50L6	.61
—	117Z3	.61



**SEND FOR FREE TROUBLE SHOOTER GUIDE AND NEW TUBE & PARTS CATALOG**

**RAD-TEL TUBE CO.**

DEPT. RE-561 55 CHAMBERS STREET, NEWARK 5, N. J.

TERMS: 25% deposit must accompany all orders, balance COD. Orders under \$5: add \$1 handling charge plus postage. Orders over \$5: plus postage. Approx. 8 tubes per 1 lb. Subject to prior sale. No COD's outside continental USA.

QUANTITY USERS • MACHINE OPERATORS  
• MANUFACTURERS • EXPORTERS

**HUGE STOCKS !!  
OVER 175 TYPES SPECIALLY PRICED !**

All tubes fully Guaranteed — Brand New!

MINIMUM ORDER . . . 500 PER TYPE . . . NO ASSORTMENT

Write, Wire, Types Needed; get our Low "Large Quantity" price

# TAKE ADVANTAGE OF THIS SUPER VALUE

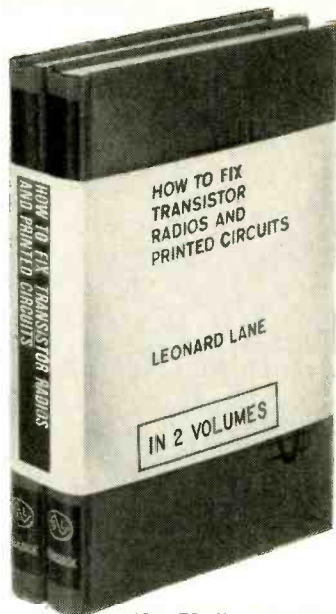

HOW TO FIX TRANSISTOR RADIOS AND PRINTED CIRCUITS

In two volumes

Join the G/L TECHNICIANS BOOK CLUB NOW

GET THIS 2-VOLUME \$9.90 SET

FOR ONLY \$6.50

HERE'S THE BOOK BUY OF THE YEAR! The most remarkable servicing books ever published at practically a give-away price. Here condensed into two fact-packed volumes you'll find all the theory and practical knowledge you need to fix transistor radios and printed circuits. Tells how and why transistors work, why they amplify, explains current and voltage gain and analyzes transistor circuits and their operation. Then it digs right into the benchwork side of servicing. The many charts, diagrams and schematics spotlight the way to fixing the toughest trouble fast. You'll learn what instruments to use, the short cuts, lots of timesavers, how to align, measure voltages, and work with printed circuits. Finally, there's a reference section for "instant servicing" with thumbnail notes on how to fix troubles fast and a directory to the chapters where you can find more detailed information on the theory and practice involved.

It's written in a crisp clear style that's easy to understand and contains much new and original material that you'll find nowhere else.

The books retail for \$9.90. But as a club member you can buy them for only \$6.50 plus a few cents postage. Join the club now and take advantage of the book buy of the year.

**NO-RISK GUARANTEE:** You don't risk a cent. SEND NO MONEY. Look the books over in your own home. Then only when you're convinced they're as good as we say, send payment. If you're not satisfied just send the books back.

### HOW TO JOIN

Just mail the coupon below. SEND NO MONEY. We'll send you the books for a 10-day No-Risk inspection in your own home. • If you like the books keep them and send us your remittance. If you don't, just send them back. • A new book is published every three months—you receive it on the same No-Risk inspection plan. • Keep only the books you want—pay only for those you keep. • You agree to take a minimum of only 4 books—over the whole enrollment period! You may cancel anytime after that. No time limit—no contract to sign.

### BUILD A WHOLE LIBRARY OF BOOKS YOU NEED TO GET AHEAD IN SERVICING

The G/L Technicians' Book Club has helped thousands of service technicians everywhere • Do Faster Servicing • Earn More Money • Save money on the books they need to get ahead.

HERE'S HOW IT CAN HELP YOU! This club offers hard-cover editions of today's best servicing books by well-known authors AT DISCOUNTS UP TO 27%! Through mass printing and direct distribution we can offer you these books AT A SPECIAL LOW PRICE plus a few cents postage.

SEND IN THIS COUPON TODAY

GERNSBACK LIBRARY, INC., Dept. 51C  
154 West 14th St., New York 11, N. Y.

Enroll me in the G/L TECHNICIANS' BOOK CLUB. Send me "How To Fix Transistor Radios and Printed Circuits" (2 Vols.).

Name ..... please print

Street .....

City ..... Zone ..... State .....

SEND NO MONEY! MAIL THIS COUPON TODAY!

You have nothing to lose — everything to gain!

Examine the books at our risk. BOOKS PURCHASED FOR PROFESSIONAL USE ARE TAX DEDUCTIBLE.

## ADVERTISING INDEX

Radio-Electronics does not assume responsibility for any errors appearing in the index below.

MAY 1961

Advertiser	Page No.
Aerovox Corp.	18
Aflex Radio Corp.	101
Alliance Mfg. Co.	(3rd Cover)
Allied Radio Corp.	9, 106
Arrow Fastener Company, Inc.	93
Atlas Sound Corp.	96
Audio Unlimited Inc.	104
Audion	108
B & K Mfg. Co.	25
Barry Electronics Corp.	109
British Industries	109
Brooks Radio & TV Corp.	105
Burstein-Applebee Co.	107
Capitol Radio Engineering Institute	23
Carston Studios	110
Castle TV Tuner Service Inc.	111
Center Industrial Electronics Inc.	96
Central Div. of Globe Union	8
Chemical Electronic Engineering, Inc.	107
CLASSIFIED ADS	111
Cleveland Institute of Electronics	11
Colordaptor	101
Columbia Wire & Supply Co.	72
Coyne Electrical School	89
Curtick Electronics	106
DeVry Technical Institute	7
Dressner	104
Duotone Co., Inc.	98
Editors & Engineers	108
Electro-Voice, Inc.	15
Electronic Chemical Corp.	114
Electronic Instrument Co. (EICO)	59
Electronic Measurement Corp. (EMC)	100
Electronic Publishing Co., Inc.	114
Electronic Organ Arts	87
Gernsback Library Inc.	116
Grantham School of Electronics	17
Heald Engineering College	104
Heath Company	62-63
Holt, Rinehart & Winston Inc.	86, 109
Indiana Technical College	110
Injectoral Company	98
JFD Electronics	10
Jerrold Electronics Co.	79
Key Electronics Co.	114
Lafayette Radio Electronics Corp.	21
Lansing Sound, Inc.	64
Lektro Inc.	99
Masters Electronics Corp.	91
Moss Electronics Inc.	84-87
Multicore	79
National Radio Institute	3, 114
National Technical Schools	5
North American Phillips Co., Inc.	102
PACO Electronics Co., Inc.	12-13
Philco (Computer Div.)	99
Picture Tube Outlet	106
Precision Tuner Service	103
Progressive "Edu-Kits" Inc.	108
Quam-Nichols Company	99
Quietrol Co., Inc.	110
RCA Electron Tube Div.	71, (Back Cover)
RCA Institutes	25-29
Racon Electric Co., Inc.	20
Rad-Tel Tube Co.	115
Radio Tube Specialist	96
Radio TV Training School	19
Remington Rand Univac (Recruitment)	92
John F. Rider, Inc.	103
Rinehart & Co., Inc.	86, 109
Sains (Howard W.) & Co., Inc.	91-95
Schober Organ Co.	24, 78
Service Instrument Corp. (Sencore)	81
Sonotone Corp.	22
Sprague Products Co.	83
Swing-O-Lite Co.	102
Switchecraft, Inc.	109
Sylvania Electric Products Inc.	(2nd Cover)
T A B	110
Tarzan, Sarks Inc.	65, 104
Triad Transformer Corp. (Litton Industries)	93
The Turner Microphone Co.	101
University Loudspeakers, Inc.	16
Utah Radio Corp.	106
Vaco Products Co.	96
Vidate Electronics Mfg. Corp.	114
Winegard Company	77, 97
Xcelite, Inc.	14

### SCHOOL DIRECTORY PAGES 112, 113

- Baltimore Technical Institute
  - Niles Bryant School
  - Canadian Institute of Science Technology
  - Indiana Home Study Institute
  - Indiana Technical College
  - International Correspondence School
  - Middleton Institute of Electronics
  - Milwaukee School of Engineering
  - Northrop Institute of Technology
  - Pacific International College of Arts & Sciences
  - Phila. Wireless Technical Institute
  - Philco Technological Center
  - Tri-State College
  - Valparaiso Technical Institute
- Printed in USA

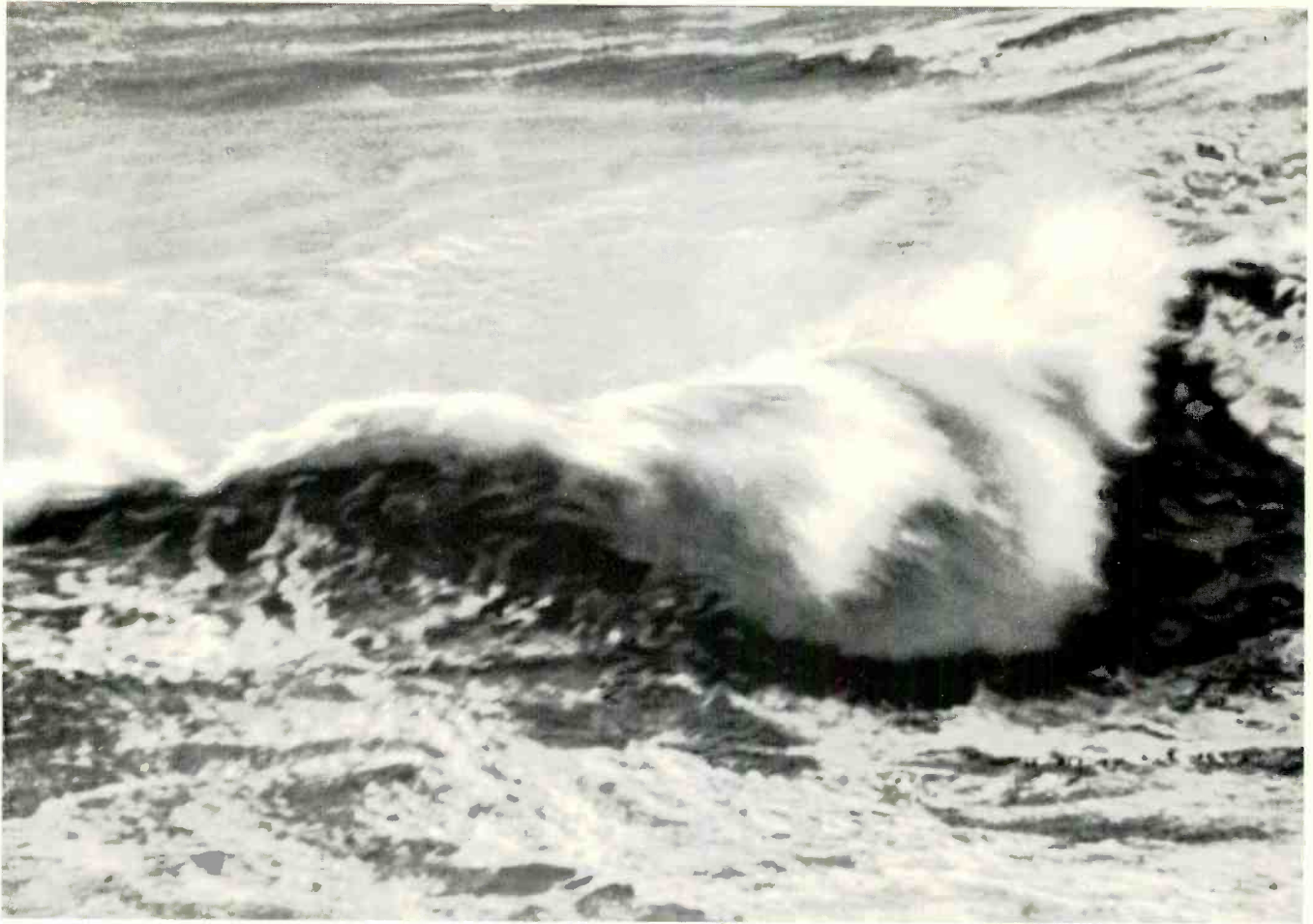

## A wave of demand...for Alliance Tenna-Rotors *Are you ready for it?*

Look at the market for TV antenna rotators.

**Color TV** . . . up 67%. And sensitive color signals demand Tenna-Rotor's accurate tuning.

**Station Changes** . . . new towers, new stations, channel reassignments, UHF and VHF. New opportunities to sell the superiority of Alliance Tenna-Rotors over "stay-put" antennas.

**New Homes**—increasing yearly. And each new home needs the Alliance Tenna-Rotor for *optimum* reception.

Be first in this onrushing market with the recognized leader! Alliance Tenna-Rotor has already sold over 4 million—has been nationally advertised way beyond its competition year after year.

The Alliance line is complete, too. With a handsome model for every need. Write for full information, today, to Alliance, Dept. E, Alliance, Ohio.

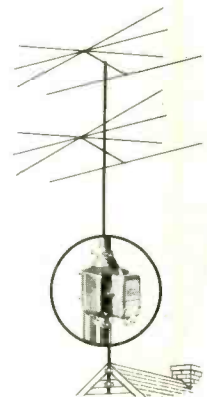

See us at The Chicago Electronics  
Parts Distributor Show, May 22-24.  
Hospitality Suite Nos. 2104-5-6-7,  
Conrad Hilton Hotel.  
Also Booth No. 687

A product of The ALLIANCE MANUFACTURING CO., Inc., Alliance, Ohio

(Subsidiary of Consolidated Electronics Industries Corp.) • World's Largest Manufacturers of Sub-Fractional H.P. Motors

TUBE QUALITY BY DESIGN



## YOUR CUSTOMERS' CONFIDENCE BEGINS HERE

From a tube design conference like this at RCA comes a stream of innovations that continually improve the quality of RCA receiving tubes you install... which in turn helps build your customers' confidence.

A typical design conference includes design and development engineers, applications engineers, production supervisors, quality-control specialists, chemists and physicists. It takes many skills to make a basic tube improvement.

This group may be discussing a more effective pattern of anti-leakage slots in tube micas; or a sturdier cage structure to minimize microphonics; or a new metal alloy to improve heat dissipation; or new shielding and basing arrangements to minimize shorts and leakage; or a new heater wire coating to improve heater performance and assure longer life.

Whatever the problem, it's attacked with a single goal in mind: to provide you with a tube you can depend on. Another reason why every RCA tube you install is an investment in customer confidence. Give yourself the extra advantage of RCA tube dependability. Check with your Authorized RCA Distributor this week. *Electron Tube Division, Harrison, N. J.*



The Most Trusted Name in Electronics  
RADIO CORPORATION OF AMERICA